



**PLEASE CHECK FOR CHANGE INFORMATION
AT THE REAR OF THIS MANUAL.**

7S14
DUAL TRACE
DELAYED SWEEP SAMPLER

INSTRUCTION MANUAL

Tektronix, Inc.
P.O. Box 500
Beaverton, Oregon 97077

070-1410-00
Product Group 42

Serial Number _____

First Printing DEC 1973
Revised APR 1985

Copyright © 1973 Tektronix, Inc. All rights reserved.
Contents of this publication may not be reproduced in any
form without the written permission of Tektronix, Inc.

Products of Tektronix, Inc. and its subsidiaries are covered
by U.S. and foreign patents and/or pending patents.

TEKTRONIX, TEK, SCOPE-MOBILE, and  are
registered trademarks of Tektronix, Inc. TELEQUIPMENT
is a registered trademark of Tektronix U.K. Limited.

Printed in U.S.A. Specification and price change privileges
are reserved.

INSTRUMENT SERIAL NUMBERS

Each instrument has a serial number on a panel insert, tag,
or stamped on the chassis. The first number or letter
designates the country of manufacture. The last five digits
of the serial number are assigned sequentially and are
unique to each instrument. Those manufactured in the
United States have six unique digits. The country of
manufacture is identified as follows:

B000000	Tektronix, Inc., Beaverton, Oregon, USA
100000	Tektronix Guernsey, Ltd., Channel Islands
200000	Tektronix United Kingdom, Ltd., London
300000	Sony/Tektronix, Japan
700000	Tektronix Holland, NV, Heerenveen, The Netherlands

TABLE OF CONTENTS

SECTION 1	CHARACTERISTICS	Page
	General Information	1-1
	Electrical Characteristics	1-1
	Vertical System	1-1
	Horizontal System	1-2
	Environmental Characteristics	1-4
SECTION 2	BASIC SEQUENTIAL SAMPLING PRINCIPLES	
	Introduction	2-1
	Equivalent-Time Sequential Sampling	2-1
	Vertical Functions	2-2
	Horizontal Functions	2-4
	Glossary of Sampling Terms	2-4
SECTION 3	OPERATING INSTRUCTIONS	
	General Information	3-1
	Mainframe Controls	3-1
	Getting A Trace On Screen	3-1
	Front Panel Controls	3-1
	Other Plug-Ins	3-7
SECTION 4	APPLICATIONS	
	Introduction	4-1
	Phase Difference Measurements	4-1
	X-Y Phase Measurements	4-1
	Dual-Trace Phase Measurements	4-2
	Time Difference Measurements	4-2
	Two-Dot Measurements	4-3
	Phase Measurements Using the Two-Dot System	4-3
	Pulse Width Measurements	4-3
	Time Between Pulses Using Dual Trace	4-4
SECTION 5	CIRCUIT DESCRIPTION	
	Vertical System	
	Compensation Network	5-1
	Delay Line	5-1
	Sampling Gate	5-1
	Sampling Gate Blow-by Compensation	5-1
	Strobe Generator	5-1
	Preamplifier	5-1
	DC Balance and DC Balance Amplifier	5-2
	Memory Gate	5-2
	Memory Gating Generator	5-2
	Memory Gate Blow-by Compensation	5-2
	Memory	5-2

TABLE OF CONTENTS (cont)

SECTION 5	CIRCUIT DESCRIPTION (cont)	Page
	Post Memory Amplifier	5-2
	Unity Gain Inverter (Channel 2 Only)	5-2
	Output Amplifier	5-3
	Switching	5-3
	Vertical Power Supplies	5-3
	Horizontal System	
	Peak-To-Peak Signal Follower	5-3
	HF Synchronizer Oscillator	5-3
	Trigger Amplifier	5-3
	Holdoff Ramp Generator	5-5
	Trigger Circuit	5-5
	Fast Ramps	5-5
	Delta Delay Generator	5-6
	Buffer	5-7
	Scan Ramp Gating Multivibrator	5-7
	Interdot Blanking Pulse Generator	5-7
	Inverter, Gating Generator, and Gated Current Generator	5-7
	Scan Ramp and Staircase Generator	5-7
	Two Dot Circuit	5-7
	Intensity Blanking Mixer	5-8
	Position Voltage Follower & Horizontal Amplifier	5-8
	Readout	5-8
	Horizontal Power	5-8
SECTION 6	MAINTENANCE	
	Preventive Maintenance	
	General	6-1
	Cleaning	6-1
	Lubrication	6-1
	Visual Inspection	6-1
	Semiconductor Checks	6-1
	Recalibration	6-1
	Troubleshooting	
	Troubleshooting Aids	6-2
	Component Identification	6-2
	Troubleshooting Equipment	6-2
	Troubleshooting Techniques	6-3
	Troubleshooting Procedure	
	General	6-4
	Test Procedure	6-5
	Horizontal Checks	6-5
	Vertical Checks	6-9
	Corrective Maintenance	
	Obtaining Replacement Parts	6-11
	Soldering Techniques	6-11
	Circuit Board Replacement	6-12
	Sampler Board Cover Removal	6-12
	Vertical Board Removal	6-12

TABLE OF CONTENTS (cont)

SECTION 6	MAINTENANCE (cont)	Page
	Sampler Board Removal	6-12
	Vertical and Horizontal Interface Board Removal	6-12
	Delay Line Removal	6-13
	Compensation Board Removal	6-13
	Trigger Board Removal	6-14
	Horizontal Board Removal	6-14
	Readout Board Removal	6-14
	Vertical Mode Switch Board Removal	6-14
	Component Replacement	
	Semiconductor Replacement	6-15
	Connector Replacement	6-15
	Push-button Switches	6-16
	Rotary Switches	6-17
	Cam Switch	6-17
	Recalibration After Repair	6-17
	Instrument Repackaging	6-17
SECTION 7	PERFORMANCE CHECKS/CALIBRATION	
	Elementary Checks and Incoming Inspection	7-1
	Detailed Checks and Adjustments	7-3
	Equipment Required	7-3
	Preliminary Connections and Set-up	7-4
	Power Supply Checks	7-4
	Triggering Checks and Adjustments	7-6
	Equipment Set-up	7-6
	Trigger Calibration Check	7-6
	Adjustment of R212 (Trig Cal)	7-8
	Sync Level Check	7-8
	Adjustment of R530 (Sync Level)	7-9
	+ Balance and – Balance Check	7-9
	Adjustment of R524 and R521 (+ Bal and – Bal)	7-9
	Sync Bias Check	7-9
	Adjustment of R209 (Sync Bias)	7-10
	Timing Checks and Adjustments	7-10
	Equipment Set-up	7-10
	2-Dot Cal Check	7-10
	Adjustment of R131 (2-Dot Cal)	7-10
	Delay Stop Check	7-11
	Adjustment of R130 (Delay Stop)	7-11
	1 μ s/Div Delaying Check	7-11
	Adjustment of R132 (1 μ s/Div Delaying)	7-11
	1 μ s/Div Delayed Check	7-11
	Adjustment of R460 (1 μ s/Div Delayed)	7-11
	Scan Rate Check	7-12
	Adjustment of R381 (Scan Rate)	7-12
	Leadtime and Register Check	7-12
	Adjustment of R472 and R230 (Leadtime and Register)	7-12
	Delayed and Delaying Timing Checks	7-12
	10 ns/Div, Delaying Check	7-13
	Adjustment of C350 (10 ns/Div, Delaying)	7-13

TABLE OF CONTENTS (cont)





SECTION 7	CALIBRATION PROCEDURE (cont)	Page
	10 ns/Div, Delayed Check	7-13
	Adjustment of C353 (10 ns/Div, Delayed)	7-13
	Delayed and Delaying Timing Verification	7-13
	1 ns Linearity Check	7-13
	Adjustment of R380 (1 ns Linearity)	7-14
	Vertical Checks and Adjustments	7-14
	Equipment Set-up	7-14
	Channel 1 Avalanche Check	7-15
	Adjustment of R20 (Avalanche for both Channel 1 and Channel 2)	7-15
	Channel 2 Avalanche Check	7-16
	Delta t Center Check	7-16
	Adjustment of R458 (Delta t Center)	7-16
	Channel 1 DC Balance, Loop Gain, and Memory Balance Checks	7-16
	Adjustment of R233, R232 and R242 (DC Bal, Loop Gain, and Memory Bal)	7-17
	Channel 2 DC Balance, Loop Gain and Memory Balance Checks	7-17
	Adjustment of R330, R331 and R344 (DC Bal, Loop Gain, and Memory Bal)	7-17
	Trigger Jitter Check	7-18
	Avalanche Recheck	7-18
	Channel 1 L.F. Comparator Check	7-19
	Adjustment of CH 1 R30 (L.F. Comp.)	7-19
	Channel 2 L.F. Comparator Check	7-19
	Adjustment of CH 2 R30 (L.F. Comp.)	7-19
	Channel 1 and Channel 2 Amplitude Attenuation Check	7-19
	Channel 1 INPUT Connector Check	7-19
	Channel 2 INPUT Connector Check	7-20
	Channel 2 Amplitude Check	7-20
	Channel 1 Amplitude Check	7-20
	Readout Checks	7-20
SECTION 8	ELECTRICAL PARTS LIST	
	Parts Ordering Information	8-1
	Abbreviations	8-1
	Cross Index, Mfr. Code Number to Mfr.	8-2
	Parts List	8-3
SECTION 9	DIAGRAMS AND CIRCUIT BOARD ILLUSTRATIONS	
	Block Diagrams	See Tabs
	Vertical Block Diagram	
	Horizontal Block Diagram	
	Electrical Schematics and Circuit Boards	See Tabs
	Compensation	
	Samplers	
	Sampler Cover	
	Trigger	

TABLE OF CONTENTS (cont)

	Page
SECTION 9 DIAGRAMS AND CIRCUIT BOARD ILLUSTRATIONS (cont)	
Vertical Mode Switch	3
Attenuator Switches	3
Vertical	4
Horizontal	5 A, 5 B, 5 C
Timing Switch	5 C
Vertical Interface	6
Horizontal Interface	7
Readout	8 A, 8 B
Interconnection and Power Distribution	9 A, 9 B
SECTION 10 MECHANICAL PARTS LIST AND MECHANICAL ILLUSTRATIONS	See Tabs

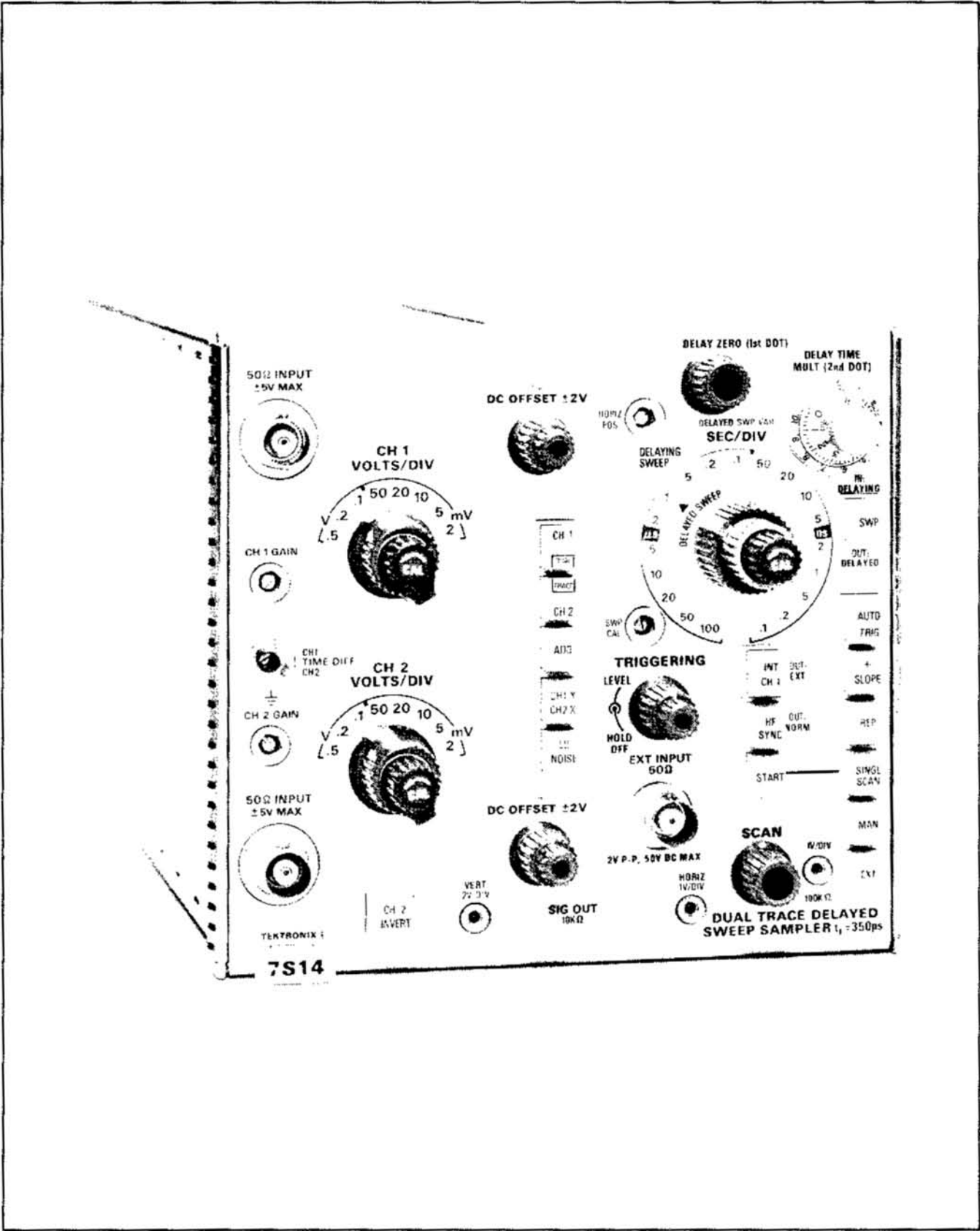

Fig. 1-1. 7S14 Dual Trace Delayed Sweep Sampler.

CHARACTERISTICS

General Information

The Tektronix 7S14 Dual Trace Delayed Sweep Sampler is a general purpose sampling unit with a DC-to-1000 MHz bandwidth. It will operate in any Tektronix 7000 Series mainframe. The front panel terminology is similar to that of conventional oscilloscopes.

The 7S14 has two time bases to provide "delaying" and "delayed sweep" operation. The delayed sweep starts after the selected delay interval, giving the effect of a wide-range sweep operation. The delayed sweep starts after the selected delay interval, giving the effect of a wide-range sweep magnifier. The calibrated delay replaces the "time position" control found on most sampling time-base units.

The 7S14 has a two dot time-interval measurement method that provides a means of measuring the time between two points on the "normal" (delaying) display. A brightened dot on the trace can be positioned to the start of the event to be measured. A second brightened dot can be positioned to the end of the event by using the Delay Time Mult control. The time interval between the two

points is the product of the reading on the Delay Time Mult dial times the Delaying Sweep Sec/Div setting.

Delay lines in the input signal channels permit display of the leading edge of the triggering waveform. The Auto Level mode provides a bright baseline in the absence of a triggering signal. Other features include 2 mV/div sensitivity, low tangential noise, versatile triggering capabilities, a broad range of sweep rates, and crt readout of both the attenuation and timing values.

The characteristics given in the following Table apply over an ambient temperature range from 0°C to +50°C after the instrument has been calibrated at +25°C ±5°C. Under these conditions, the 7S14 will perform to the requirements given in the Performance Check section of this manual.

The Supplemental Information column of the Table provides additional information about the operation of the 7S14. Characteristics given in the Supplemental Information column are not requirements in themselves and are not necessarily checked in the Performance Check procedure.

ELECTRICAL CHARACTERISTICS

Characteristics	VERTICAL SYSTEM	
	Performance Requirements	Supplemental Information
Risetime	350 ps or less, 10% to 90% of step pulse signal.	
Step Aberrations	+2%, -3%, total of 5% or less P-P within first 5 ns after step transition; +1%, -1%, total of 2% or less P-P thereafter.	Check made with Tektronix 284 Pulse Generator; includes aberrations from the 284.
Bandwidth (-3 dB)	DC to 1 GHz or more.	Calculated from risetime.
Input Resistance	50 Ω within 2%.	
Deflection Factor	2 mV/Div to 0.5 V/Div.	8 steps, 1-2-5 sequence.
Accuracy	Within ±3% (with VARIABLE at CAL).	
Variable	At least 2.5:1.	Extends uncalibrated deflection factor to approximately 800 μV/Div.
Input Signal Range		
Maximum Operation	2 V P-P (DC + Peak AC) within a +2 V to -2 V window at any sensitivity.	
Maximum Overload	±5 V.	

ELECTRICAL CHARACTERISTICS (cont)

VERTICAL SYSTEM (cont)

Characteristics	Performance Requirements	Supplemental Information
DC Offset Range	+2 V or more to -2 V or more.	
Displayed Noise (tangential)	2 mV or less, LOW NOISE switch "out".	
Low Noise Operation	Displayed noise reduced by at least five times.	
Vertical Signal Out	0.2 V/Div of deflection $\pm 3\%$.	Source resistance is 10 k Ω $\pm 0.5\%$.
Dot Slash	Less than 0.1 Div at 10 Hz and above.	
Interchannel Crosstalk	-60 dB or less.	When input signal is 0.5 GHz sine wave.
ΔT Range	Shifts Channel 2 at least +1 ns to -1 ns with respect to Channel 1.	Range may be centered with internal adjustment.

HORIZONTAL SYSTEM

Delaying Time Base

Time Base Range	100 μs /Div to 10 ns/Div.	13 steps, 1-2-5 sequence.
Time Base Accuracy	Within $\pm 2\%$, excluding first $\frac{1}{2}$ division of displayed sweep.	No time mark between 1st and 9th divisions can be more than 0.2 divisions from the major division line when the 1st mark is set on the 1st division line.
Delay Zero Range	0-9 divisions or more.	When Delay Time Multiplier is set to 0.00, the 1st dot can be moved past the 9th graticule line.
Delay Time Multiplier	Each turn equal to 1 crt division.	Delaying Time/Div X Delay Time Mult = Time between dots.
Delay Accuracy	Within 1% of full screen (10 crt divisions) when measurement is made between 1st and 9th crt divisions.	

Delayed Time Base

Time Base Range	100 μs /Div to 100 ps/Div.	19 steps, 1-2-5 sequence.
Accuracy	Within $\pm 3\%$, excluding first $\frac{1}{2}$ division of displayed sweep.	No time mark between 1st and 9th divisions can be more than 0.3 divisions from the major division line when the 1st mark is set on the 1st division line.
Variable	At least 2.5:1.	Extends uncalibrated Time/Div to approximately 40 ps/Div.

ELECTRICAL CHARACTERISTICS (cont)

HORIZONTAL SYSTEM (cont)		
Characteristics	Performance Requirements	Supplemental Information
Time Base Display Modes		
Delaying Time Base		Conventional display, maximum lead time. Left intensified dot indicates Time Zero (Multiplier Zero). Right intensified dot indicates point at which Delayed Sweep starts. Time between dots is read from the crt or the Delay Time Multiplier dial.
Delayed Time Base		Delayed sweep display starts immediately at end of delay time. Set by Delay Zero plus Delay Time Multiplier. Operates in same manner as "run after delay" mode in conventional oscilloscopes except Time Zero is adjustable and identified.
Triggering		
Amplitude Range External Internal	10 mV to 2 V, P-P. 50 mV to 2 V, P-P.	Rate of rise, 10 mV/ μ s or faster. At Sampler Input (vertical input signal). Rate of rise, 50 mV/ μ s or faster.
Input Resistance	51 Ω within $\pm 10\%$, AC coupled.	
Jitter	Less than 40 ps with 50 mV, 5 ns width trigger at external input. Less than 30 ps when internally triggered from 284 pulse.	
NORMAL Triggered Mode		
Sine waves	150 kHz to 100 MHz.	
Pulse	10 Hz to 100 MHz.	
Minimum Rise Rate	10 mV/ μ s.	
AUTO TRIG Mode (Auto baseline when not triggered)		
Sine waves Minimum Amplitude	150 kHz to 100 MHz. 10 mV P-P at 100 MHz (Ext).	
Pulse Minimum Pulse Width Minimum Rise Rate	1 kHz to 100 MHz. 10 ns at 1 kHz. 10 mV/ μ s.	Auto baseline below 800 Hz.

ELECTRICAL CHARACTERISTICS (cont)

HORIZONTAL SYSTEM (cont)		
Characteristics	Performance Requirements	Supplemental Information
HF SYNC Mode		
Sine waves	100 MHz to 1 GHz.	Free-Running Sync.
Scan Controls		
Repetitive	25-40 Hz Repetition Rate.	Repetition rate barely into flicker rate. Controls must be set as follows: Low Noise Control, out; HF SYNC Control, in; Scan Control, fully CW; Holdoff control, fully CCW; Delaying sweep, 1 μ s/Div or faster; Approximately 20 samples per div at low trigger or sweep rates.
Single Sweep	One sweep per Single Sweep Start button depression.	Scan Rate is the same as set in Repetitive mode.
Manual	Scan control moves the spot over a slightly greater range than 10 divisions.	
Ext Scan		
Maximum Sensitivity	1 V/Div within $\pm 5\%$.	Scan control serves as an attenuator. Full scale scan signal must run from 0 V to +10 V or more.
Maximum Input Voltage	150 V.	
Horizontal Output Signal Amplitude	1 V/Div $\pm 5\%$.	Source resistance is 10 k Ω within $\pm 0.5\%$.

ENVIRONMENTAL CHARACTERISTICS

Characteristics	Description
Temperature	
Operating Range	0°C to +50°C.
Non-operating Range	-40°C to +70°C.
Altitude	
Operating Range	To 15,000 feet.
Non-operating Range	To 50,000 feet.
Vibration Range	To 0.025 inch peak-to-peak displacement at 55 cycles per second.
Shock Range	To 30 g, 1/2 sine, 11 milliseconds duration.
Transportation (Non-operating)	Meets National Safe Transit Test Requirements.

BASIC SEQUENTIAL SAMPLING PRINCIPLES

Introduction

Sampling provides the means to display fast-changing signals of low amplitude that cannot be displayed in any other way. Sampling overcomes the gain-bandpass limitation inherent with conventional amplifiers and oscilloscopes. It does so by displaying a real-time signal in "equivalent" time. Only the input stage of a sampler is subjected to the input signal; all subsequent signal amplification takes place through relatively low bandwidth amplifiers.

Sampling, however, does require repetitive input signals. Fortunately, most fractional-nanosecond risetime signals exist in low impedance environments; thus they may be delivered directly through 50 ohm cables to a 50 ohm load. They are generally low amplitude signals, so 50 ohm attenuators are used when the signal is more than one or two volts.

There are three types of sampling: sequential, random, and real-time. The 7S14 uses the sequential sampling method; this technique will be discussed in this section of the manual.

Equivalent-time Sequential Sampling

The sampling system looks at the instantaneous amplitude of a signal during a specific small time period, remembers the amplitude, and displays a single dot on the crt that corresponds to the amplitude. The horizontal position of the dot represents the equivalent time when the sample was taken. After a dot is displayed for a fixed amount of time, the system again looks at the instantaneous amplitude of a different cycle of the input signal.

Each successive look, or sample, is at a slightly later time in relation to a fixed point of each sampled signal cycle. After many cycles of the input signal, the sampling system has reconstructed and displayed a single facsimile made up of many samples, each sample taken in sequence from a different cycle of the input signal; thus, the term "sequential sampling".

Because the reconstructed signal is not completed until long after the first signal cycle has occurred, it is not displayed in "real" time. The time displayed on the crt is termed "equivalent-time". Such a display is shown in Fig. 2-1. The equivalent time between dots is determined by the time delay between the fixed point on the signal at which sweep triggering occurs and the point at which the sample is taken. The real-time and equivalent-time relationship is depicted in Fig. 2-2. Since both time references (triggering and sampling) are taken from the same cycle of the signal, the signal repetitions do not have to be identical in amplitude, time duration, and shape. Periodic differences in individual cycles, however, will show as noise or jitter in the reconstructed display if the shape or amplitude changes from cycle to cycle.

The number of dots per horizontal division in one sweep is called dot density. Since only one sample is taken from any particular input cycle, the time needed to reconstruct a display depends on the dot density and the repetition rate of the signal. The greater the dot density and the slower the repetition rate, the longer the time to construct the equivalent-time display.

Sampling systems have maximum signal repetition rates at which samples can be taken and accurately displayed.

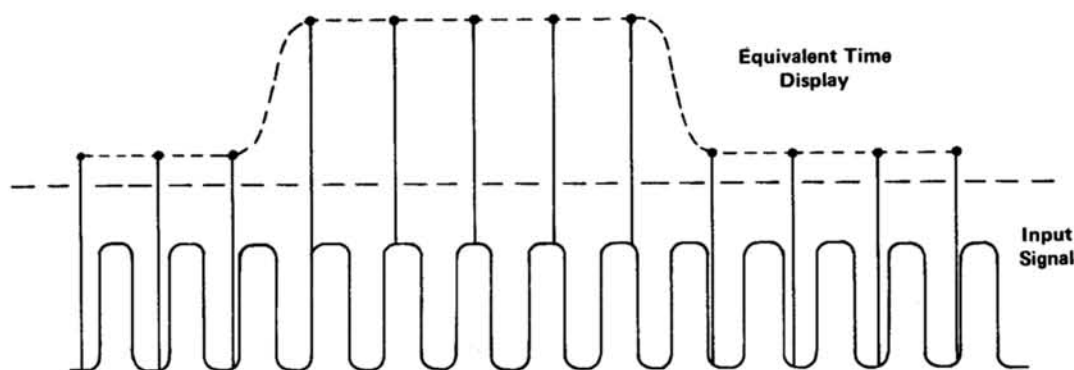

Fig. 2-1. Input pulse of a repetitive real-time signal is reconstructed in an equivalent-time display via sequential sampling.

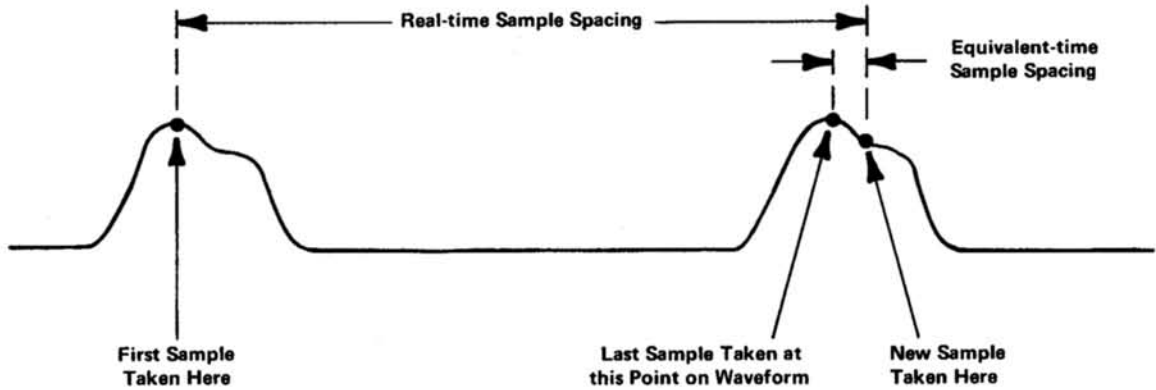

Fig. 2-2. Real-time and equivalent-time relationship.

The primary limit is the time needed for the vertical amplifiers to stabilize after a sample has been taken. For signals with a repetition rate higher than 30 kHz, the timing unit holds off retriggering for a maximum of approximately 35 μ s. This means that a sample will not be taken from every cycle of a high repetition rate signal; only those cycles are sampled that occur after the end of the trigger holdoff. If the signal is truly repetitive and each cycle is identical, these "missed" cycles are of little significance.

Signals below 30 kHz may have considerable repetitive rate jitter, but the sampling oscilloscope can still give a sample of each cycle without display jitter because triggering and sampling both occur on the same cycle.

Vertical Functions

The sampling oscilloscope's vertical stages perform the same basic functions as those in a nonsampling oscilloscope: i.e., signal amplification and attenuation. Vertical signal delay is also used to permit viewing a signal's leading edge.

All the amplification and signal processing in the sampling oscilloscope (except for the passive 50 ohm input) is done at relatively low frequencies. It is this feature that makes the sampling oscilloscope unique in performance and design.

Sampling begins with the input signal being changed to stored, long duration, low frequency voltages consisting of brief portions (samples) of the input. This change is not a frequency conversion; rather, it is a different way to represent the input signal.

The sampled energy is stored in a memory circuit so that it stays constant between samples. Each time a new sample is taken, the memory is refreshed. The amount of sampled and stored energy represents the amplitude of the input signal when that sample is displayed on the crt.

Vertical stages in a sampling oscilloscope include some not found in a nonsampling oscilloscope, such as a Sampling Gate, Blow-by Compensation, Preamplifier, Memory Gate, Memory Amplifier and Feedback, and Memory Gating Generator. Circuit descriptions for these stages appear in Section 5. In summary, stage purposes are: Sampling Gate samples brief portions of the input signal; Blow-by Compensation nullifies unwanted signal coupling; Preamplifier and Memory Amplifier and Feedback keep the Sampling Gate output and Memory constant between samples, making the Sampling Gate output proportional to its input; the Memory Gate passes the sampled signal to the Memory; and the Memory Gating Generator turns on the two gates.

An important part of the sampling process is a sampling loop. This loop provides in-phase feedback of the sampled and memory energy to the Sampling Gate output. The feedback forms a null-seeking servo loop that attempts to make a zero difference between the Sampling Gate input and output.

When the gain of the feedback loop is unity, it compensates for the attenuation across the Sampling Gate. In this case, the feedback voltage equals the value of the sampled input signal voltage. When the loop gain is less than unity, the feedback voltage is less than necessary to equalize the voltage across the gate. The Memory output and feedback will then approach the signal asymptotically after several samples have been taken. The Memory output

is effectively a moving average of several preceding samples. When the loop gain is greater than unity, the feedback voltage is greater than the Sampling Gate input signal. The resulting crt display of a step signal input will alternately overshoot and undershoot for a few samples. For the least display distortion, the loop gain must be unity, allowing the system to track the input signal as closely as possible.

A loop gain of less than unity can be useful, if the resulting condition is understood and the system is operated properly. Random noise in the display is reduced when loop gain is less than unity, since several consecutive samples are averaged. The averaging, however, will slow the risetime of an abrupt step signal depending on the number of dots in the step transition and how much less than unity the loop gain may be. Averaging will also reduce the amplitude of a sine wave if there are not enough dots per cycle.

When the memory gate is open, it passes the sampled signal and charges a capacitor in the memory gate output. This stored charge remains essentially constant until another sample is taken. The memory output is not reset to zero after a given sample, but is held at the level of the previous sample by the feedback signal.

In the memory gate output there is a LO NOISE control that reduces the random noise seen at high sensitivities. The function of this control is known as "smoothing," in that it smoothes or averages several consecutive samples. A check for whether smoothing is producing any distortion is accomplished by increasing the number of dots in the display with the SCAN control and observing whether there is any significant change in the waveform.

Fig. 2-3 shows the usual effects of smoothing for two different sampling densities (sampling density or dot density is the number of samples or dots per horizontal division).

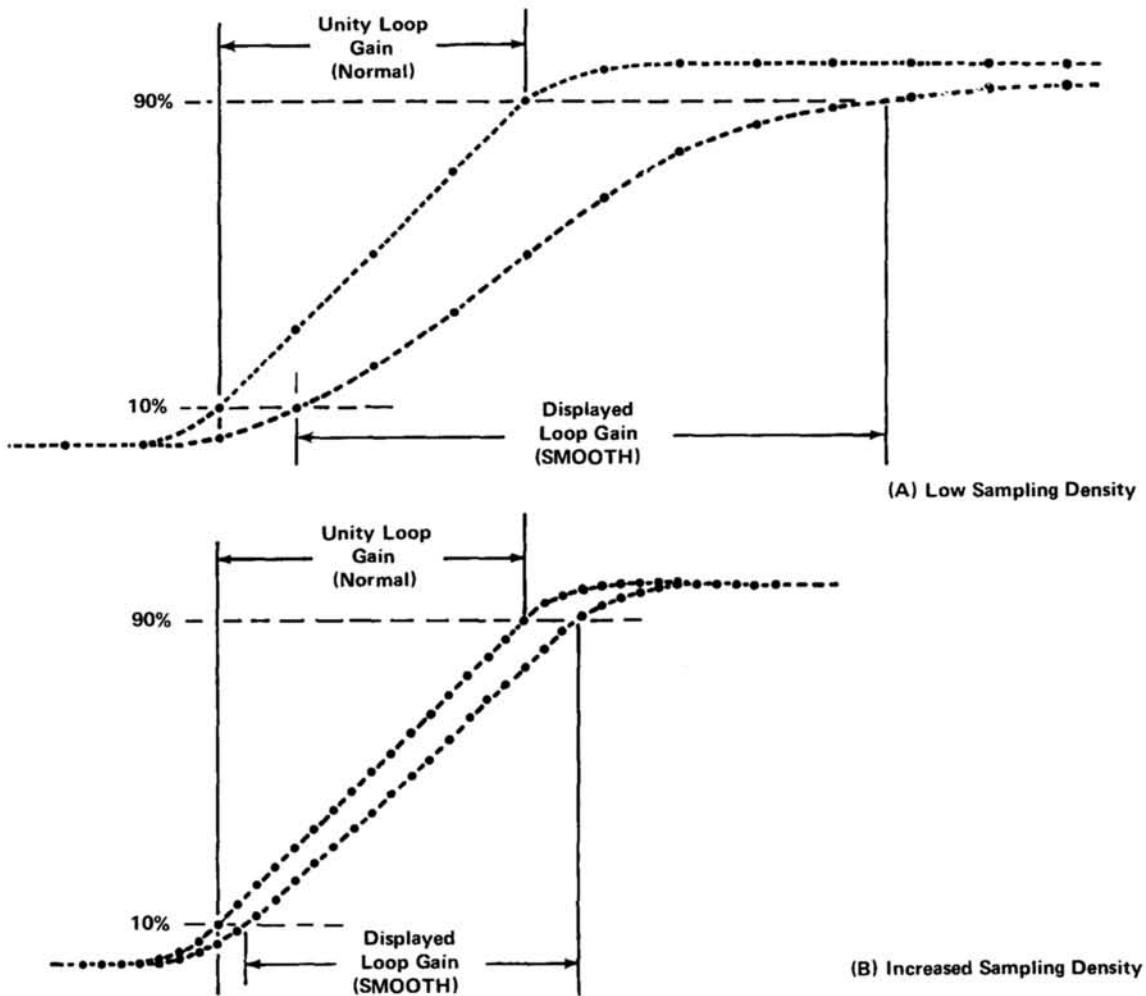

Fig. 2-3. Equivalent-time display with and without smoothing for two different sampling densities.

Basic Sequential Sampling Principles—7S14

The signal out of the memory gate gets amplified by the memory circuit. Each change in voltage at the memory output is a step change proportional in amplitude to a step at the input to the preamplifier.

On sampling systems having two input channels, such as the 7S14, there are two sets of sampling-loop circuits. The output from each of the memories is fed to a channel switching multivibrator that selects which output each dot represents, so that either channel can be displayed, or so that both channels can be displayed, as two traces, by alternating outputs with each successive dot.

Horizontal Functions

The Horizontal system provides deflection voltage for the crt display and simultaneously controls the time at which the vertical system samples the input signal. The system uses (1) a 1 GHz trigger circuit, (2) two fast ramps for either Delaying sweep or Delayed sweep operation, (3) a combination scan ramp and staircase generator to provide horizontal deflection and a comparison level for the fast ramps, (4) two intensified positionable dots to provide an accurate dial read-out for time measurements and (5) a delay generator to provide strobe drive to the two vertical channels so that the signal at one input channel may be sampled consistently earlier than, later than, or coincident with the signal at the other input.

The sampling oscilloscopes's horizontal sweep is produced by a staircase voltage that advances one step each time a sample is taken. One cycle of the input signal causes the trigger circuit to initiate one cycle of the sampling process and produce one dot for the display.

The sampling cycle starts when the trigger circuit recognizes a point in a cycle of the triggering signal and unclamps the fast ramp generator. The fast ramp generator produces a linear rundown voltage that is compared to the slowly changing staircase voltage. The resulting pulse that occurs the instant the fast ramp voltage level equals the staircase voltage level is sent to the vertical circuit via the Delta Delay Generator as a strobe drive pulse. From there the strobe also goes to the Scan Ramp and Staircase Generator as a staircase-advance pulse.

The staircase generator advances one step just after the sampling circuit takes a sample of the input signal. The sampling memory output is applied to the vertical amplifier and the staircase output level is applied to the horizontal deflection system of the oscilloscope. As soon as the sample

has been taken, a dot is displayed on the crt screen at a vertical position proportional to the input signal voltage level at the instant it was sampled. The dot then remains stationary on the screen until another sample is taken.

Each subsequent recognized triggering signal cycle initiates the same sequence of events. But since the staircase voltage moves down one step each time, the fast ramp has to run slightly farther each time before a comparison pulse is produced. In this way the sampling event is delayed by successively longer intervals and the samples are taken successively later along the waveform with respect to the triggering point. Each time a sample is taken, the crt is blanked momentarily while the dot on the crt moves horizontally by one increment.

The 7S14 contains a "two-dot circuit" that provides two bright dots for each trace. With the two dot circuit it is possible to position the dots to two specific points in the waveform and measure the time interval between the points directly from the 2nd dot positioning control.

Glossary of Sampling Terms

There are many terms used in the discussion of sampling systems whose definitions may not be universal. The following terms, used in this manual, have been compiled to help avoid confusion.

Blow-by—A display aberration resulting from signal-induced displacement current through all capacitance shunting the Sampling Gate.

Display Window—The particular time interval represented within the horizontal limits of the graticule.

Dot—A displayed spot indicating the horizontal and vertical coordinates of a particular sample.

Dot Density—The number of dots per horizontal division in any one scan.

Equivalent Time—The time scale represented in the display of a sampling oscilloscope operating in the equivalent-time sampling mode.

Equivalent-time Sampling—A sampling process in which a least one repetitive signal event is required for each sample taken. The time required for display construction is thus greater than the time represented in the display.

Fast Ramp or Slewing Ramp—A linear ramp which acts with a slower staircase, ramp, or other changing voltage to cause slewing.

Feedback—The effective intersample attenuation in the signal path between Memory output and Sampling Gate output in a sampling loop.

Forward Gain—The effective gain between the Sampling Gate output and Memory output in a sampling loop.

Loop Gain—The product of sampling efficiency, forward gain and feedback attenuation in a sampling loop. Loop gain is normally unity except in a smoothed display where it may be less than unity.

Memory—A circuit which stores the vertical (or horizontal) coordinate value of a sample.

Memory Gate—An electronic switch between a Memory and its driving amplifier.

Pretrigger—A trigger signal which occurs before a related signal event.

Real Time—The time scale associated with signal events.

Sampling—A process of sensing and storing one or more instantaneous values of a signal for further processing or display.

Sampling Efficiency—The ratio of the voltage change between the instant before sampling, t^- , and the instant after sampling, t^+ , at the output of a Sampling Gate to the difference between gate input voltage, E_i , and gate output voltage, E_o , at the instant before sampling.

$$E = \frac{E_o(t^+) - E_o(t^-)}{E_i(t^-) - E_o(t^-)}$$

Sampling Gate—An electronic switch which conducts briefly upon command for the purpose of collecting and storing the instantaneous value of a signal.

Sampling Loop—Those circuits providing the main signal path through the Sampling Gate, Preamplifier, Loop Gain attenuator, DC Balance Amplifier, Memory Gate, Memory, and the Feedback attenuator.

Scanning—The process by which slewing is controlled.

Sequential Sampling—A sampling process in which samples are taken at successively later times relative to a fixed point of each sampled signal cycle.

Slewing—The process of causing successive samples to be taken at different instants relative to a fixed point of each sampled signal cycle.

Smoothing—A process that reduces the effect of random noise or jitter in the display by averaging several consecutive samples.

Strobe—A pulse of short duration which operates the Sampling Gate.

OPERATING INSTRUCTIONS

General Information

The 7S14 is a double-width plug-in unit containing both vertical and horizontal deflection circuits. The 7S14 operates in any Tektronix 7000 Series mainframe when the unit is completely inserted into the proper two slots of the mainframe plug-in compartment. When inserted into mainframes that accommodate three single-width plug-ins, the two slots toward the operators right should be used. The middle two slots should be used in four-hole mainframes.

NOTE

When the 7S14 is used in the R7603, R7613, R7623, or R7903 rackmount instruments, the support posts between the rackmount plug-in compartments must be removed so that the dual width 7S14 can be inserted into the mainframe.

A blank plug-in panel may be used to cover the opening of any slot not occupied by a plug-in unit. Use panel 016-0155-00 for 7000 Series mainframes.

Assuming it is clean and dry, the plug-in unit is ready to operate as soon as it has been correctly installed in the mainframe. However, the mainframe power cord must first be plugged into a power outlet that supplies AC voltage of the correct frequency and amplitude and the mainframes power switch must be turned on. It should not be necessary to turn the power off before removing or inserting the plug-in unit.

Mainframe Controls

Besides the power switch, there are other switches and controls on the mainframe that must be set for the 7S14 to operate correctly. If you are not already familiar with the functions of the mainframe controls you may need to refer to the instruction manual for that mainframe.

Getting A Trace On Screen

With power applied and the plug-in properly inserted, the next step is to get a trace on screen. The recommended procedure is to (1) temporarily disconnect any vertical input or trigger input signals, (2) select the repetitive scan mode by pushing the REP button, (3) select $1\ \mu\text{s}$ per division or faster for the DELAYING SWEEP (dark gray) control, (4) free-run the time base and sampling circuits by pushing the AUTO TRIG and HF SYNC buttons, (5) select Channel 1 Vertical input by pushing the CH 1 button, (6) set the Channel 1 VOLTS/DIV control to the least sensitive position, counterclockwise to .5 V, (7) center the

Channel 1 DC OFFSET controls, and (8) adjust the mainframe crt intensity control for a medium bright trace. If a trace does not appear under these conditions, it is likely that either some mainframe control was incorrectly set, or that the mainframe or plug-in unit is not functioning properly.

Front Panel Controls

A brief description of the purpose and use of each front panel connector, pushbutton, control, and screwdriver-adjustment on the 7S14 follows. If you have never operated a sampling oscilloscope, you should read the entire section before proceeding to display a signal waveform. You should refer to Fig. 3-1 as a guide to specific operating instructions relating to each front panel control or connector.

1. 50 Ω INPUT $\pm 5\ \text{V MAX}$

These are input connectors to both Channel 1 and Channel 2 sampling gate circuits and vertical deflection amplifiers. Signals as large as 2 V P-P in amplitude may be handled, as long as no swing exceeds +4 volts or -4 volts. However, peak signal excursions that exceed +2 volts or -2 volts cannot be displayed at the more sensitive setting, even when using maximum DC OFFSET. Voltage greater than ± 5 volts may alter the accuracy of precision delay line compensation resistors or cause input circuit components to fail. External probes or 50 ohm attenuators should be used to display signal voltages greater than 4 volts. The following probes are recommended: P6056, 10X probe; P6057, 100X probe; P6201, 1X, 10X and 100X FET probe. You will need a 1101 Power Supply for the P6201 probe if the mainframe does not have a probe power output jack. The BNC 50 ohm attenuators recommended are: 011-0059-02 (10X), 011-0060-02 (5X), and 011-0069-02 (2X). Signals as great as ± 20 volts peak or 14 volts RMS may be applied to these attenuators before exceeding the wattage rating. 50 ohm attenuators having connectors other than the BNC type may be used if adapters to BNC connectors are available.

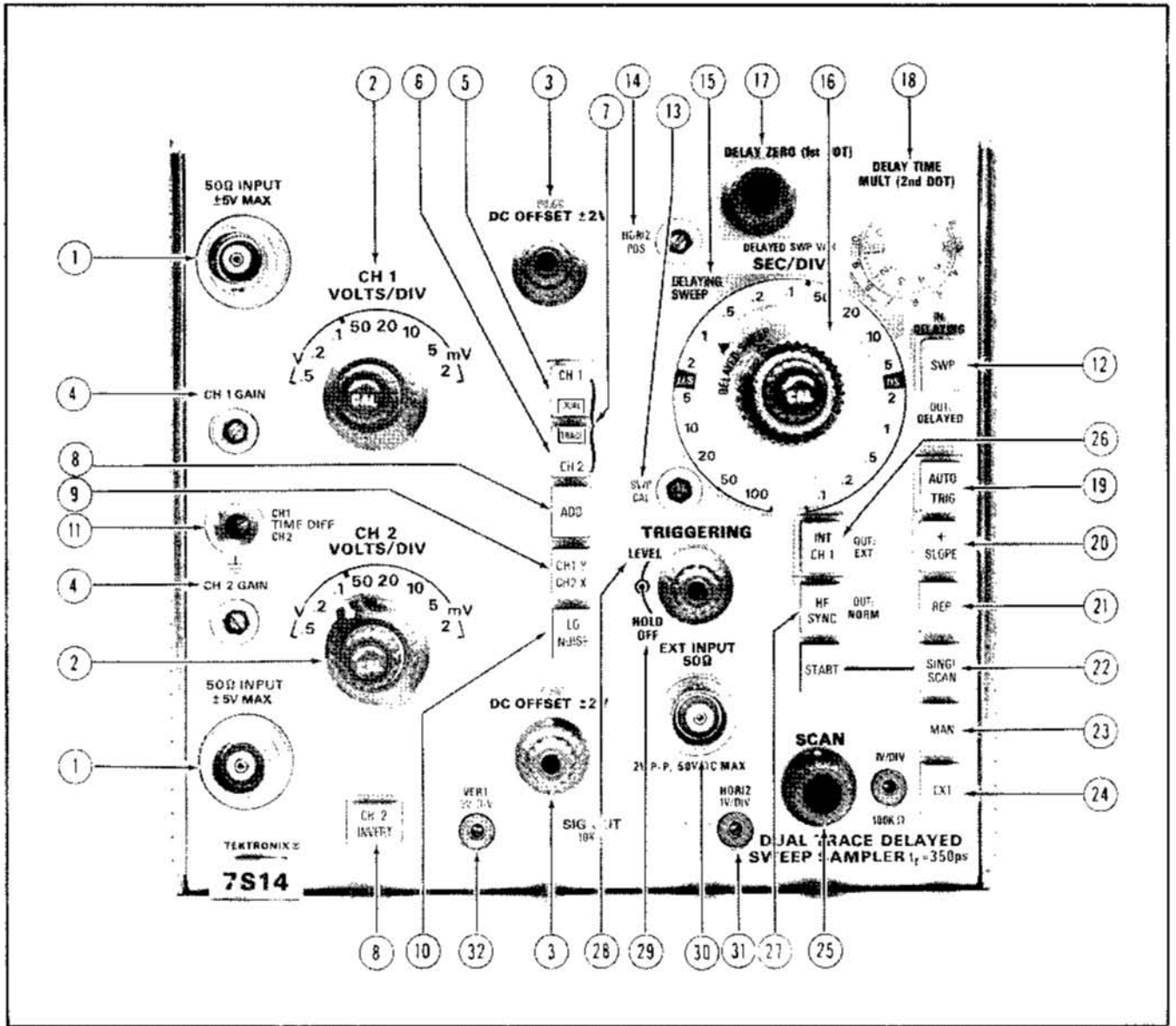

Fig. 3-1. Key to Operating Instructions.

2. CH 1
VOLTS/DIV
and
CH 2
VOLTS/DIV

The outer control selects the vertical deflection factor from .5 V/Div to 2 mV/Div. The red variable control (CAL) adjusts sensitivity over a range of at least 2.5 to 1. The two controls provide any sensitivity between .5 V per division and .8 mV per division. The CAL control must be set in the fully counterclockwise (detented) position before the indicated deflection factor can be expected to be accurate.

3. DC OFFSET
±2 V

These two controls position the display up or down or position a signal on screen that otherwise may be off screen. A signal riding on a DC level as great as +2 volts or -2 volts may be positioned to center screen. The FINE control makes it easier to precisely position the display at high sensitivities.

4. CH 1 GAIN
and
CH 2 GAIN

These screwdriver adjustments set the gain of the corresponding channels so that the chosen deflection factor corresponds to the deflection displayed on the crt by a signal voltage of known amplitude. For example, a signal of precisely 1 volt P-P amplitude should produce five divisions of deflection when the VOLTS/DIV is .2 V. Each adjustment should normally be checked each time a plug-in is placed in a different mainframe.



The applied signal voltage should be from a 50 ohm source so that the voltage arriving at the input may be precisely one half of the open circuit, unloaded voltage value.

5. CH 1

Push this button to display a signal at Channel 1 input.

6. CH 2

Push this button to display a signal at Channel 2 input. There is no internal signal pickoff from Channel 2 input; internal triggering is from the signal picked off from Channel 1. Therefore, if you have only one input signal it should be connected to CH 1 input unless you use an external trigger input signal or using a power divider, first divide the signal so part may be applied to the external trigger input jack.

7. DUAL TRACE

Dual trace operation is achieved by pushing both CH 1 and CH 2 buttons at the same time.

8. ADD
and
CH 2 INVERT

Pushing the ADD button allows the signals at CH 1 INPUT and CH 2 INPUT to be, in effect, summed. Actually, the summing operation is performed on the sampled replicas of the two input signals following the vertical channel memories. This button should normally be pushed when two balanced, push-pull signals are applied to the CH 1 and CH 2 INPUTS. You may then also push the CH 2 INVERT button to achieve, in effect, differential input operation. Or, if you wish to see how similar the two halves of the

push-pull signal may be, any difference between them can be displayed by leaving the CH 2 INVERT button out.

To display the difference between two similar signals that have nearly the same polarity or phase and the same amplitude, the CH 2 INVERT button should be pushed.

NOTE

A front panel screwdriver adjustment (CH 1-TIME DIFF-CH 2) can be set for very precise phase or time comparisons. Refer to a later discussion of the purpose of that control.

9. CH 1 Y
CH 2 X

This button should be pushed for X-Y displays, such as Lissajous patterns. The signal applied to the Channel 1 input produces vertical deflection (Y) in the normal way and the signal applied to the Channel 2 input produces horizontal deflection (X). When using this mode, neither the DELAYING SWEEP nor DELAYED SWEEP controls affect the display in any way, except to change the maximum possible number of samples per second. Set the DELAYING SWEEP time per division to 10 ns and the triggering HOLDOFF control fully counterclockwise to ensure the greatest possible number of samples per second. The cleanest X-Y displays are achieved by triggering or synchronizing in the usual way before pushing the CH 1 Y-CH 2 X pushbutton.

10. LO NOISE

Push this button to reduce the amplitude of random noise in the display or, in some cases, to reduce horizontal time-jitter. It is normal for the horizontal scan rate to reduce greatly when this button is pushed.

11. CH 1
TIME DIFF
CH 2

This screwdriver control should normally be set (and is set at the factory) so that identical signals applied to the two inputs will be displayed in precisely the same horizontal positions. For example,

if a single signal is applied to the middle port of a coaxial tee and the output from each of the other two ports is applied through similar cables of precisely equal length to the two input channels, a dual trace display should show two nearly identical waveforms that can be made to coincide with the DC OFFSET controls. If a very fast step-signal is applied in this manner and displayed at 100 ps per division, the fast edge of either signal may be seen to be positionable horizontally with the CH 1-TIME DIFF-CH 2 control so as to occur before, after, or coincident with the fast edge of the other input signal.

Although this control should normally be left set so two such signals can be made to coincide, the control may also be deliberately set to other positions to (1) compensate for the delay difference in two input cables or (2) critically compare two similar repetitive signals that do not occur simultaneously. If you wish to use this control to critically compare two such signals that occur at widely separated instances, two similar cables of unequal length may be used at the proper inputs if the difference in length is chosen to introduce a propagation delay difference nearly equal to the time between the events. Most coaxial cables, i.e., those made with a dielectric of solid polyethylene, cause a signal delay of approximately 1.5 ns per foot (50 ps per cm). The delay through most other cables will be less; some nearly as little as 1 ns per foot.

12. SWP (MODE)

Push this button to display a signal when sweep delay is not needed, unless the time per division must be less than 10 ns. Pushing this button allows the Delaying Sweep to determine the crt time per division. Releasing the button allows the Delayed Sweep to determine the crt time per division.

When the Delayed Sweep is selected to determine the crt time per division, the delaying sweep ramps are used in conjunction with the

DELAY ZERO and DELAY TIME MULT controls to select the delay needed to display the signal of interest.

13. SWP CAL

This screwdriver adjustment sets the amplitude of the horizontal output signal (to the mainframe) to produce the correct deflection on the crt to correspond with any time per division selected. Ideally, the adjustment should be checked using a time mark generator each time the 7S14 is placed in a different mainframe. However, if internal adjustments in the plug-in are set correctly, the SWP CAL adjustment may be set using the two intensified dots displayed in each trace when using the Delaying Sweep mode. There should be precisely 8 divisions of separation between corresponding parts of the two dots when (1) the Delaying Sweep is set to 1 μ s per division, (2) the DELAY TIME MULT dial is set to 8.00, and (3) the DELAY ZERO control is set to position the first dot one horizontal division from the left edge of the crt graticule.

14. HORIZ POS

This screwdriver adjustment should be used to set the left edge of a trace even with the left edge of the crt graticule after the SWP CAL adjustment has been made.

15. DELAYING SWEEP

The time indicated between the orange lines on the clear plastic skirt of the DELAYING SWEEP (dark gray) control is the crt time per division when the Delaying Sweep has been selected (SWP mode button pushed in).

16. DELAYED SWEEP

The time indicated at the point of the arrow on the clear plastic skirt of the DELAYED SWEEP (light gray) control is the crt time per division when the Delayed Sweep has been selected (SWP mode button released). Be sure that the concentric, red CAL control is counterclockwise in the detented position; otherwise, the indicated time per division will not be correct. The CAL control varies the time per division over a range of at least 2.5 to 1.

To reduce delay time-jitter and to increase scan rate, the time per division of the Delaying Sweep should be as close as possible to the time per division of the Delayed Sweep. Ten divisions of delay is available when both sweep rates are the same. When more than ten divisions of delay is needed, the Delaying Sweep time per division must be set to be greater. If set to be 1,000 times longer, 10,000 divisions of delay is available, but delay time-jitter may be as much as 1/2 division.

17. DELAY ZERO
(1st DOT)

When using the Delaying Sweep mode, this control is used to set the position of the first intensified dot in the trace to a point in the displayed waveform suitable to be called time-zero, a beginning reference point for a time interval measurement. You will notice that this control usually moves the second dot as well. If, in some cases, it appears that you cannot position the first dot as far to the right as you may wish, it is probably because the second dot is at the right end of the trace. You may avoid this condition by running the DELAY TIME MULT dial completely counterclockwise first.

18. DELAY TIME
MULT (2nd DOT)

This dial controls the separation between the first and second bright dots in a trace when the Delaying Sweep mode is selected. It controls the position of only the second dot until the second dot is positioned to the right end of the trace, at which time it continues to control the separation between dots by moving the first dot to the left. The point in a waveform identified by the second dot is the point corresponding to the left edge of the trace that you display when you switch from the Delaying Sweep mode to the Delayed Sweep mode (SWP mode button released).

The number indicated on the dial is proportional to the separation between dots; one turn equals one division. The time between dots is equal to the time indicated between the orange colored lines on the skirt of the clear plastic DELAYING

SWEEP control multiplied by the number indicated by the dial. Precise time interval tests of whether the time between two particular points in a waveform is greater than or less than a given amount may be quickly made by first separating the dots by the right amount, then positioning them with the DELAY ZERO control to see whether the distance between dots is more than or less than the distance between the two particular points in the waveform.

19. AUTO
TRIG

Push this button for nearly every triggering signal or condition you may encounter, except when the triggering signal has a frequency or repetition rate less than about 800 hertz. When this button is pushed, strobe pulses are automatically generated (at about 800 hertz) when no triggering signal is being delivered or recognized. This keeps the sampling memories refreshed, produces a slow moving scan and keeps the crt beam positionable on screen even in the absence of a triggering signal.

20. +
SLOPE

Push this button when you wish to trigger on the positive-going portion of a signal. Release the button when you wish to trigger on a negative-going portion. The position of the button is immaterial when the HF SYNC button is pushed.

21. REP

The REP button should be pushed whenever repetitive scans (sweeps) are desired, which is the condition for most normal uses.

22. SINGL
SCAN
and
START

Push the SINGL SCAN button when you wish to produce only one scan at a time; this scan is displayed on command by the START button. This mode is useful when photographing waveforms where the scan repetition rate is low, or for stored displays when using an oscilloscope mainframe having a storage crt. It is also recommended when making chart recordings using the VERT and HORIZ output signals. Note that each scan starts when the spring loaded START button is released, not when it is

pushed. The HORIZ output voltage returns to -5 volts when the START button is pressed and remains at about +5 volts at the completion of each scan. When driving a chart recorder, the START button should be held in while the recording apparatus is being set. The scan rate should be very slow when making chart recordings. Refer to the discussion about the SCAN control knob and the LO NOISE pushbutton, to set the scan rate as low as desired.

23. MAN

Push this button when you wish to scan the crt manually, instead of with the internally generated scanning ramp signal or with an externally supplied scanning signal. The scan control determines the point being sampled. This mode is particularly useful when you wish to repeatedly sample the same point in a signal for a period of time. High random noise may be separated from the signal this way by averaging the voltage at the VERT output jack.

24. EXT¹

Push this button when you wish to control the horizontal position of the crt beam with an externally supplied scanning signal. The input jack adjacent to the EXT pushbutton is for introducing such a signal. A zero to +10 volt (or higher) signal is needed to produce a full scale horizontal scan. A signal that goes from zero to more than +10 volts may be attenuated with the SCAN control to produce ten divisions of scan. This mode is useful when you wish to slave the scan operation to an external instrument such as a chart recorder.

25. SCAN

This control determines the horizontal velocity of the crt beam (scan rate) whenever the REP button or the SINGL SCAN button is pushed. (This rate is partly determined by some other factors also, like trigger repetition rate, holdoff, time per division, and whether the LO NOISE button is pushed or released.)

26. INT
CH 1

Push this button to trigger on the internal signal introduced at the Channel 1, 50 Ω INPUT connector. Release this pushbutton to trigger on the external triggering signal introduced at the EXT INPUT connector.

27. HF
SYNC

Push this button to synchronize on signals above 100 MHz. Be sure to release the pushbutton when triggering on any signal below 100 MHz.

28. LEVEL

The LEVEL control is used to "lock" on to the triggering or synchronizing signal to reproduce a steady, coherent waveform on the crt. The triggering signal must have a steady, synchronous time relationship with the vertical signal for the display to be steady.

29. HOLDOFF

The HOLDOFF control is normally left fully counterclockwise to allow a maximum scan rate. The HOLDOFF control is used to help display complex waveforms and pulse trains, such as digital words, by varying the period of trigger holdoff. That inhibits recognition of early, unwanted triggering signal edges.

30. EXT INPUT
50 Ω

This input connector is AC coupled into a nominal 50 ohm load. The blocking capacitor has a DC voltage rating of 50 volts and more than 1 megohm resistance. External triggering signals may be delivered to this input via a 50 ohm coaxial cable, unattenuated. For large signals the P6056 10X probe or P6057, 100X probe is recommended. When AC coupled, the DC load resistance imposed by these probes is essentially the same as that of the blocking capacitor, i.e., more than 1 megohm.

31. HORIZ
1 V/DIV¹

The signal voltage available at this output pin jack is proportional to the horizontal position of the beam at any instant; zero volts corresponds to approximately center screen. The output waveform resembles that of a sawtooth or staircase when produced internally, using the REP or SINGL SCAN modes. The output voltage starts at

¹Pin tip plugs of 0.08 inch diameter should be used with the pin jacks.

–5 volts and goes positive to +5 volts as the beam scans the ten crt divisions. The output waveform is most often used to drive chart recorders. Also refer to the discussion of the SINGL SCAN control.

32. VERT
.2 V/DIV¹

The signal available at this output pin jack is a replica of the signal that produces vertical deflection. This waveform is most often used to drive chart recorders.

Other Plug-Ins

Most any vertical plug-in may be used in a limited way with the 7S14. However, you should remember that the horizontal scan rate of the beam is not calibrated in the

7S14, and the time per division selected by the SEC/DIV switch does not set the horizontal velocity of the beam as with conventional oscilloscope time base plug-ins. The 7A13 Differential Comparator is a particular useful example, because it is often used to measure DC levels or peak signal levels when the signal waveform is of no importance. It may be placed alongside the 7S14 to produce a time-shared three-trace display when the 7S14 is used in the DUAL TRACE mode. The DISPLAY pushbutton on the other plug-in must be pushed to display a signal with that plug-in.

With the four-hole mainframe series, it is possible to use a horizontal plug-in and a vertical plug-in in conjunction with the 7S14. This is particularly useful in that the same mainframe can be used to troubleshoot the 7S14.

For a complete explanation of uses of the mainframe, refer to the operating manual for the particular mainframe.

APPLICATIONS

Introduction

The display waveform on the crt screen propagated by a 7S14 is a plot of voltage per unit equivalent time. Since the 7S14 has calibrated deflection factors both vertically and horizontally, the sampling system can be used for making accurate voltage and time measurements of an input signal.

The 7S14 offers dual-trace capabilities that allow the user to simultaneously view two signals and determine the time and amplitude relationship between the two signals. In addition, dual trace operation allows interactive displays of the two signals; e.g., X-Y and added algebraically.

The 7S14 also provides a two-dot time-interval measurement that provides a means of measuring the time between two points of a display. The two dots represent two points in time on the delaying sweep of the 7S14.

The dual trace capabilities and the two-dot system provide a great versatility for measurements. Some of the applications will be discussed in the following paragraphs.

PHASE DIFFERENCE MEASUREMENTS

The time difference between two sine-wave signals of the same frequency may be measured by using one of the signals as the reference and observing the phase difference between the reference and the second signal. There are two convenient methods of measuring the phase difference using the 7S14. The main differences in the two methods are in terms of accuracy and convenience.

Signals other than sinusoidal can be measured using these techniques, but the discussion here will be confined to sine-wave applications. With signals other than sine waves, the resultant display will depend on the waveshape of the applied signal. The calculation methods given in this discussion apply only to sine-wave signals.

X-Y Phase Measurements

When displaying sinusoidal signals, the X-Y phase measurement method provides a Lissajous display. This method can be used to measure the phase relationship of two identical frequencies, or to display the frequency relationship between two signals that are harmonically related. Other uses for the Lissajous display are to check distortion of a signal or as a "null detector" for accurately matching phase. X-Y phase measurements can be made up to the bandwidth limit of the sampler. This is possible because

sampling requires high-frequency circuitry only at the input to the system; low frequency measurement techniques are used through the amplifiers and to produce the display.

To set up the 7S14 for a correct X-Y display, push the following buttons: CH 1 Y CH 2 X, INT CH 1, AUTO TRIG, + SLOPE, and REP. Set the DELAYING SWEEP and DELAYED SWEEP controls to $.1 \mu\text{s}$. Connect one of the signals to both inputs through a power divider and identical cables. Adjust the DC OFFSET and TIME DIFF controls for a straight-line display, slanted from the upper right toward the lower left corner of the crt. Adjust the deflection factors of both channels, using the variable controls as necessary, to obtain a display that is exactly six divisions both vertically and horizontally. The display should appear similar to Fig. 4-1, indicating that the cables and two channels have been matched for minimum difference.

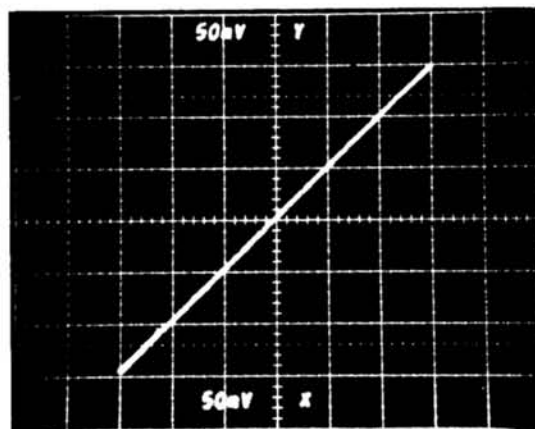

Fig. 4-1. An X-Y display of two in-phase sine wave signals.

Disconnect the power divider and connect the signals to be measured to the two inputs using the same cables used in the set-up. Check that the display is still six divisions both vertically and horizontally; adjust the deflection factor as necessary for the correct display. A difference in phase between the two signals is shown by the amount of opening in the loop. A circle display shows 90° phase difference and a straight line from the upper left to lower right shows 180° phase shift. The phase difference between two signals can be accurately measured by reading the lengths A and B, as shown in Fig. 4-2, and applying the formula:

$$\sin \theta = A/B.$$

The Lissajous figure can be used as a null indicator, to adjust the phase shift through a device, or between devices. To do this, the 7S14 must be set up for an X-Y display and

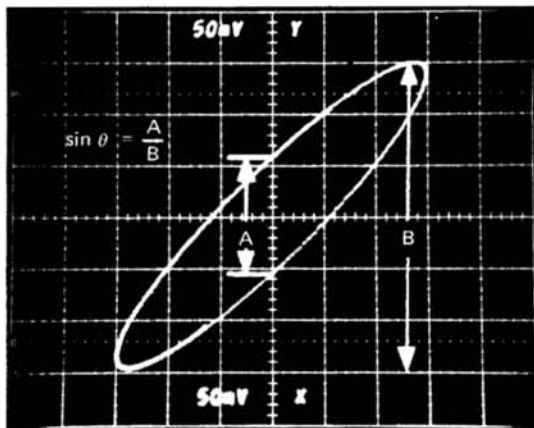

Fig. 4-2. Phase difference between two signals.

the delay compensation adjusted as described before. After the delay compensation has been adjusted, apply the signals to the inputs through the cables used for the set-up. Then, calibrate the unit under test for a "null" (zero delay) indication, as shown by a straight line display from the upper right to lower left of the graticule. Other reference points can be chosen such as a full circle to indicate 90° delay, straight line from upper left to lower right for 180° delay, or any other display which indicates the desired amount of delay.

The "null" display can also be used to make accurate frequency adjustment. After setting up the system with the reference signal, connect the signal to be adjusted to the other input. As the frequency of this signal is adjusted, a stable Lissajous display will be obtained only when the frequencies of the two signals are matched. At other frequencies, the display will appear to rotate on screen.

Dual-Trace Phase Measurement.

This phase measurement method provides a very accurate means of determining phase difference, where very small differences exist between the two signals. For this measurement, the signals must be the same frequency.

To set-up the 7S14 for correct display, push the following buttons: CH 1, INT CH 1, AUTO TRIG, + SLOPE, and REP. Connect the primary or reference signal to both inputs through a power divider and identical cables (the same cables which will be used for the measurement). Adjust the DELAYED SWEEP (light gray) control and the SWP VAR (CAL) control so that one complete cycle of the signal spans exactly eight horizontal divisions. This calibrates the system in terms of degrees/division such that there is 45°/division (i.e., 360° is equal to 8 divisions).

Now push both CH 1 and CH 2 buttons simultaneously for dual-trace operation. With the same vertical deflection on both channels, adjust the CH 1 and CH 2 DC OFFSET and TIME DIFF controls so that the two traces coincide. Disconnect the power divider and reconnect the reference signal to the Channel 1 Input. Connect the other signal to the Channel 2 Input. If necessary, adjust the vertical deflection factors so that the waveforms are the same height vertically. Now measure the distance between the corresponding points on the waveform and multiply by 45°/division to determine the exact phase difference. For small phase differences, a more precise measurement can be made by using the delayed sweep for magnification (do not change the variable control setting). The magnified horizontal rate can be determined by dividing the previous rate (45°/division) by the amount of magnification. Fig. 4-3 shows a typical magnified display.

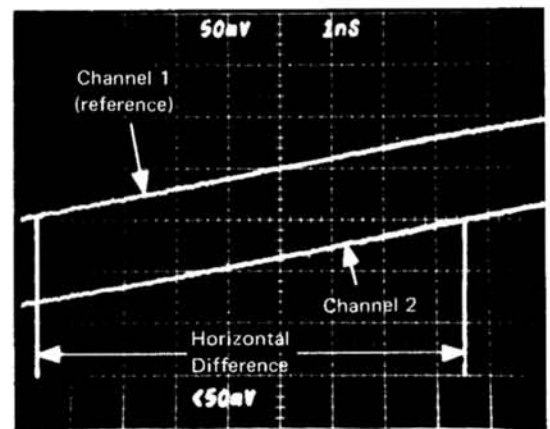

Fig. 4-3. Magnified display of signal with a small phase difference.

TIME DIFFERENCE MEASUREMENTS

The basic techniques of time-difference measurements are the same as for phase measurements. This measurement method is normally used when viewing two signals that are not time related. After setting the instrument up in the same manner as described for Phase Difference Measurements and connecting the two signals to the Channel 1 and Channel 2 Inputs, adjust the vertical deflection factors, if necessary, so that the waveforms are the same height vertically. Adjust the time per division so that the points on the two waveforms between which the time-difference measurement is to be made, are displayed within the graticule area. Now measure the distance between the desired points on the two waveforms and multiply it by the time per division. This will provide accurate time difference if the DELAYED SWP VAR control is in the calibrated position when the measurement is in the Delayed (SWP button out) Mode. When in the Delaying Mode the variable control has no effect.

TWO-DOT MEASUREMENTS

The two-dot measurement method permits more accurate time-measurement of signals. The following are examples where the two-dot system is useful.

Phase Measurements Using the Two-Dot System

For signals where the time/division is set at 10 ns/division or greater, a faster, more accurate phase measurement can be made using the two-dot system. The two-dot system is more accurate because the time base accuracy can be ignored. The two-dot phase measurement is made in the following manner.

Set up the 7S14 by pushing the following buttons: CH 1 and CH 2, INT CH 1, SWP, AUTO TRIG, and REP. Connect the primary or reference signal to both inputs through a power divider and identical cables. Adjust the DELAYING SWEEP (dark gray) control for maximum horizontal display for one complete sine wave. With the same vertical deflection on both channels, adjust the CH 1 and CH 2 DC OFFSET and TIME DIFF controls so that the two traces coincide exactly. Disconnect the power divider and reconnect the reference signal to the Channel 1 Input. Connect the other signal to the Channel 2 Input. If necessary, adjust the vertical deflection factors so that the waveforms are the same height vertically. This should create a display similar to that shown in Fig. 4-4.

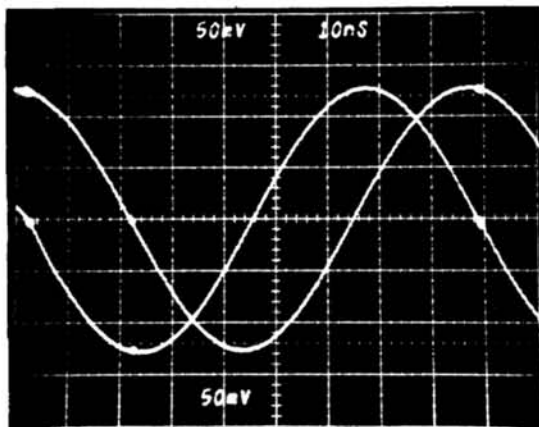

Fig. 4-4. Display of phase difference with two-dot system.

Once you have the signals displayed as in Fig. 4-4, the DELAY ZERO (1st DOT) control is used to set the first dot to the point where the reference waveform first crosses the horizontal centerline. The DELAY TIME MULT (2nd DOT) control is set to position the second dot to the point where the reference waveform crosses the horizontal centerline one complete cycle later. Note the reading on the DELAY TIME MULT dial (the number of dial divisions corresponds to 360° , or one cycle). Now change the DELAY TIME MULT control to move the second dot to where the second waveform first crosses the horizontal centerline and note the reading on the DELAY TIME

MULT dial. The phase difference between the two signals is calculated using the formula:

$$\text{Phase Difference} = \frac{\text{Second DTM Reading}}{\text{First DTM Reading}} \times 360^\circ$$

Pulse Width Measurements

Pulse width measurements are often necessary, and while they are not particularly difficult, they can be time consuming. This is especially true if the 50% points do not conveniently fall on the vertical graticule lines of the crt. With the two-dot system, it is relatively simple to measure pulse width. The pulse to be measured is displayed using the Delaying Sweep (SWP button pushed in). The sweep rate and vertical deflection factor are selected to present the entire pulse on-screen, using as much of the screen as possible. Buttons that are to be pushed in are as follows: CH 1, SWP, AUTO TRIG, + SLOPE, and REP.

After the instrument has been set up, a signal has been triggered, and the deflection factors are chosen, turn the crt intensity down enough that the two bright dots can be easily seen. Then, adjust the DELAY ZERO (1st DOT) control so that the first dot is located at the 50% point on the leading edge of the waveform. Adjust the DELAY TIME MULT (2nd DOT) control so the second dot is located at the 50% point of the trailing edge of the waveform. See Fig. 4-5 for a typical display. The pulse width is the product of the DELAY TIME MULT dial setting and the SEC/DIV (DELAYING SWEEP) control setting.

If the rise and fall times are fast, you may notice more than one bright sampling dot on the rise and fall. This is because the bright dot occupies about one-tenth of a division on a horizontal trace. The beam is sometimes deflected vertically more rapidly than it is horizontally, so the brightened portion appears longer vertically than

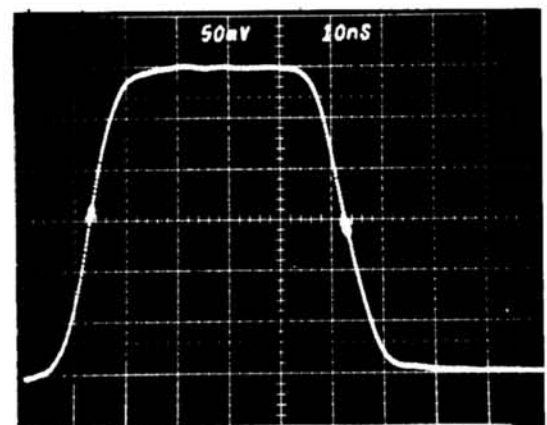

Fig. 4-5. Display of pulse width with two-dot system.

Applications—7S14

horizontally. To avoid making an error in the time measurement, make sure you set the beginning of both the "start" and "stop" dots at the 50% points. Remember that the sweep is moving left to right, so the beginning of the bright dot is at the left.

Time Between Pulses Using Dual Trace

The two-dot system is very useful for measuring the time between two independent pulses. To set up the 7S14 for a correct display, push the following buttons: CH 1 and CH 2, INT CH 1, SWP, AUTO TRIG, + SLOPE, and REP. Connect the primary or reference signal to both inputs through a power divider and identical cables (the same cables to be used for the measurement). Adjust the DELAYING SWEEP (dark gray) control for a maximum horizontal display for one complete waveform. With the same vertical deflection on both channels, adjust the CH 1 and CH 2 DC OFFSET and TIME DIFF controls to make the two traces coincide. Disconnect the power divider and reconnect the reference signal to Channel 1 Input. Connect the other signal to the Channel 2 Input.

Once the two pulses have been properly displayed, adjust the DELAY ZERO (1st DOT) control until the first dot is set to the 10% point of the rising edge of the reference pulse. Then adjust the DELAY TIME MULT (2nd DOT) control until the second dot is set to the 10% point of the rising edge of the second pulse. (The 10% points are used to provide more accurate measurements between pulses with different risetimes.) The delay between the two pulses is now determined by multiplying the DELAY TIME MULT setting by the DELAYING SWEEP SEC/DIV setting.

You will notice that there are four bright dots on-screen. The first dot on each trace indicates the delay selected by the DELAY TIME MULT control. The two dots that are not indicating a measurement point can be ignored.

There are many measurements that can be made with the 7S14. Only a few basic techniques have been presented in this section of the manual.

CIRCUIT DESCRIPTION

This section of the manual describes circuit operation of the 7S14 using a block diagram analysis. The circuit functions follow the description of each circuit. The 7S14 has triggering and time base circuits as well as vertical deflection circuits. The Vertical System is described first, followed by the description of the Horizontal System. The block and circuit diagrams at the end of the manual should be used in the analysis.

VERTICAL SYSTEM

The vertical system amplifies and attenuates the input signal. A delay line permits viewing a signal's leading edge. The two vertical channels in the dual-trace 7S14 are basically the same. The block diagram analysis discusses channel number one, with channel differences noted as they arise.

Compensation Network

The Compensation network reduces the effects of input pulse distortion in the delay line. For channel number one, the Compensation network also provides a trigger takeoff point. Input signals incur a 50% attenuation through the network, which consists of passive RC and RL components.

Delay Line

The Delay Line delays the arrival of the applied signal to the Sampling Gate long enough for the timing unit to trigger and start the ramps; this permits viewing the leading edge of signals.

Inherent with the Delay Line is some high frequency distortion (called "dribble up") of a step signal. Effects of this distortion are compensated for in the Compensation Network.

The Delay Line consists of a length of 50 ohm, low-loss transmission line with a signal propagation time of approximately 65 nanoseconds.

Sampling Gate

The Sampling Gate periodically passes a small portion of the input signal; i.e., it samples the input signal.

The gate is a bridge network consisting of a dual diode CR1 and bias cells BT1 and BT2. The diodes are held off by the cells except when strobed by Strobe Generator pulses.

When the diodes are on, they pass the input signal to the Preamplifier. Only a small percent of the input signal passes through the gate because of its low transmission efficiency (sampling efficiency).

The sampled signal charges the Sampling Gate output stray capacitance, Preamplifier input stray capacitance, and Strobe Generator coupling capacitors C1 and C2. Also charging these capacitors are two positive feedback signals: one from the Preamplifier and one from the Memory. With the feedback signals, the Sampling Gate output becomes the same as the input.

Sampling Gate Blow-by Compensation

A small part of a high frequency signal couples through the capacitance of the Sampling Gate diodes when they are back biased and not conducting. This signal is called blow-by and is undesirable. A Sampling Gate Blow-by Compensation circuit inverts the input signal and applies some of it to the output of the Sampling Gate to nullify the unwanted capacitively coupled signal.

The Sampling Gate Blow-by Compensation circuit consists of: inverter Q30; an internally adjustable gain control called LF Compensation, R30; and feedback capacitor C30.

Strobe Generator

The Strobe Generator produces fast opposite polarity pulses used to turn on the Sampling Gate. It consists of avalanche transistor Q10, whose operating voltage is controlled by the voltage controller Q20 and internally adjustable Avalanche Voltage control R20.

Signals from the Delta Delay Generator drive the avalanche transistor whose breakdown characteristic gives the high speed output pulses. In the avalanche transistor output, there is a shorted transmission line that generates the pulses.

Preamplifier

The Preamplifier brings the Sampling Gate output level up to that of its input. Positive feedback via C45 from the Preamplifier output to the Sampling Gate output gives a bootstrap operation. This feedback effectively reduces the capacitance of the Sampling Gate output by charging the capacitance with the in-phase feedback signal.

Negative feedback from the voltage divider consisting of R229, R231, and R232 provides amplifier stability and

Circuit Description—7S14

establishes loop gain. Loop Gain is internally adjustable and controlled by R232. The Preamplifier consists of a dual FET Q40 driving integrated circuit operational amplifier U10.

DC Balance and DC Balance Amplifier

In passing through the Preamplifier, the sampled signal undergoes a change in its DC level. The DC Balance and DC Balance Amplifier restores the proper DC level. It also provides a low-impedance input to the Memory capacitor C248 and the Lo Noise capacitor C247. The Balance and Balance Amplifier unit consists of internally adjustable balance control R233 and integrated circuit operational amplifier U230.

Memory Gate

Whereas the Sampling Gate has a fast risetime response, the other vertical amplifiers and circuits through which the sampled signal passes have a slower risetime response. To accommodate the slower risetimes, the Memory Gate is used.

The Memory Gate, FET Q240, acts as an on-off switch to pass the sampled signal from the DC Balance Amplifier to the Memory. Pulses that turn on the Memory Gate originate in the Strobe Logic circuits, which will be detailed later. The Strobe Logic circuits also drive the Strobe Generator and Sampling Gate; however, the Memory Gate is on longer than the Sampling Gate.

The signal passed by the Memory Gate charges one or two capacitors in its output. One capacitor, C248, is always in the circuit. The other, C247, is paralleled with C248 when the Lo Noise switch is operated. With both capacitors in the circuit the Memory Gate output cannot charge to as high a level as it could with just C248. Thus, the gate output cannot equal the input signal at the instant a sample is taken, and it will take more than one sample to display the true value of the input signal. This effect is known as "smoothing".

Memory Gating Generator

Providing turn-on pulses for the Memory Gates in both channels is a common Memory Gating Generator, Q310 and Q311. This driver amplifies and shapes strobe pulses from the Strobe Logic circuit and feeds them to the Memory Gate.

Memory Gate Blow-by Compensation

A small part of the Memory Gating Generator pulse capacitively couples through the Memory Gate via the FET gate terminal. This signal is called blow-by and is undesir-

able. A Memory Gate Blow-by Compensation circuit inverts the driver pulse and applies some of it to the output of the Memory Gate to nullify the unwanted capacitively coupled signal.

The Memory Gate Blow-by Compensation circuit consists of: inverter Q241, an internally adjustable gain control called Gate Balance, R242; and feedback capacitor C249.

Memory

The Memory amplifies the Memory Gate output signal and feeds back an in-phase signal to the Sampling Gate output. The amplified signal (X1 gain) drives the Post Memory Amplifier. The feedback signal combines with the positive feedback signal from the Preamplifier to keep the Sampling Gate output charge from leaking off with time. The positive feedback from the Preamplifier keeps the instantaneous charge replenished; feedback from the Memory ensures a constant charge over a long time period and for signals with a low repetition rate.

Dual FET Q140 and integrated circuit operational amplifier U140A compose the Memory. Negative feedback from the amplifier output to Q140 provides amplifier stability.

Post Memory Amplifier

The Post Memory Amplifier provides a maximum gain of 7.63, adjustable with front-panel Variable Attenuation (VOLTS/DIV CAL) control R109 and front-panel Gain screwdriver adjustment R119. DC OFFSET control R115, paralleled with FINE adjust control R114, provides a DC offset voltage to the amplifier that allows the operator to shift the vertical position of the display.

Integrated circuit operational amplifier U140B is the Variable Vertical Amplifier.

Unity Gain Inverter (Channel 2 only)

The Unity Gain Inverter inverts the Channel 2 signal to reverse its display direction; e.g., a negative-going input gives an upward display. The Channel 2 Invert switch selects the inverted mode or (in the noninvert position) bypasses the Channel 2 signal with no inversion. Channel 1 is not affected by the inverter switch.

Integrated circuit operational amplifier U350 is the Inverter Amplifier.

Output Amplifier

The Output Amplifier gives a constant output of 200 mV/Div for all operating levels of signals applied to the vertical input. The gain of this amplifier is controlled by the Volts/Div switch and is such that the overall amplification from the vertical signal input to the Output Amplifier output gives a deflection factor of 200 mV/Div at the Output Amplifier output.

Fig. 5-1 shows fixed gains of 0.5 for the Compensation Network, 7.63 for the Post Memory Amplifier (in calibrated mode), and from 0.105 to 26.2 for the Output Amplifier. Other stages have unity gain. With, for example, a 2 mV signal applied to the vertical input and with the Volts/Div switch set for 2 mV/Div, the overall gain is $0.5 \times 7.63 \times 26.2 = 100$; this gain of 100, with the 2 mV signal, gives the required 200 mV/Div deflection factor.

Integrated circuit operational amplifier U250 is the Output Amplifier.

Switching

The switching networks are common to both channels and consist of the Channel Switching Multivibrator and the Vertical Channel Switch. The Channel Switching Multivibrator is controlled by the Channel 1 - Channel 2 switches on the front panel. The multivibrator pulses the Vertical Channel Switch to select which output to display. The Vertical Channel Switch takes the pulses from the Channel Switching Multivibrator and selects the trace to be displayed by the mainframe.

The Channel Switching Multivibrator consists of transistors Q354 and Q351. The Vertical Channel Switch consists of FETs Q352 and Q353.

Vertical Power Supplies

The 7S14 vertical section contains two regulators that provide +30 V, and -30 V supplies. The remainder of the voltage supplies to the vertical section are provided by the mainframe. The Power Distribution is shown on schematics 9A and 9B at the rear of the manual.

The +30 V supply is developed by integrated circuit U1, transistor Q1 and zener diode VR610 (see Diagram 6). The -30 V supply is developed by integrated circuit U3, transistor Q3 and zener diode VR613. The above U and Q numbers are those located on the Vertical Interface board. The Vertical Interface board is shown on schematic 6 at the rear of the manual.

HORIZONTAL SYSTEM

The Horizontal System provides deflection voltage for the display oscilloscope and simultaneously controls the time at which the vertical system samples the input signal. The system uses a 150 KHz to 1 GHz trigger circuit, two fast ramps (delaying and delayed sweep) to generate the real time sweep, a slow scan ramp to generate the equivalent time sweep, an amplifier, a scan ramp inverter, a two dot position circuit for the horizontal measurement and a delay generator for the strobe drive to the vertical system.

Peak-To-Peak Signal Follower

When the Auto Trig mode is selected, the Peak-To-Peak Signal Follower provides an amplified voltage to the Triggering Level control and the Auto Baseline Trigger circuit.

The circuit has both a positive and a negative signal circuit. A positive input signal is received by transistor Q421 and passed through transistor Q430 to charge capacitor C430 to a positive peak amplitude. A negative input signal is received by transistor Q420 and passed through transistor Q520 to charge capacitor C531 to a negative peak amplitude. The +Bal and -Bal potentiometers, R524 and R521, calibrate the internal voltage level so that it is approximately ± 200 mV at the outputs of operational amplifiers U430 and U530.

HF Synchronizer Oscillator

The HF Synchronizer Oscillator is used for input signals above 100 MHz and is controlled by the HF SYNC button on the front panel. The circuit is a free-running oscillator that operates from 16.5 to 25 MHz.

The circuit, consisting of tunnel diode CR221 and back diode CR220, is coupled to coil L220 and internally adjustable resistor R209, which controls the bias. When one of the diodes is in its higher voltage state, the other is in its lower voltage state, with the back diode controlling the tunnel diode to its low state. The current to the diodes is determined by the Triggering Level control, the coil determines the time each diode is turned on.

Trigger Amplifier

The Trigger Amplifier is an exclusive OR circuit, in which the first stage provides trigger polarity control. The circuit has a X25 gain. When the Triggering Level control is connected through the Trigger Level Comparator circuit, it raises or lowers the level of the trigger signal at the input to the Trigger Amplifier.

Integrated circuit U220 is the Trigger Amplifier network.

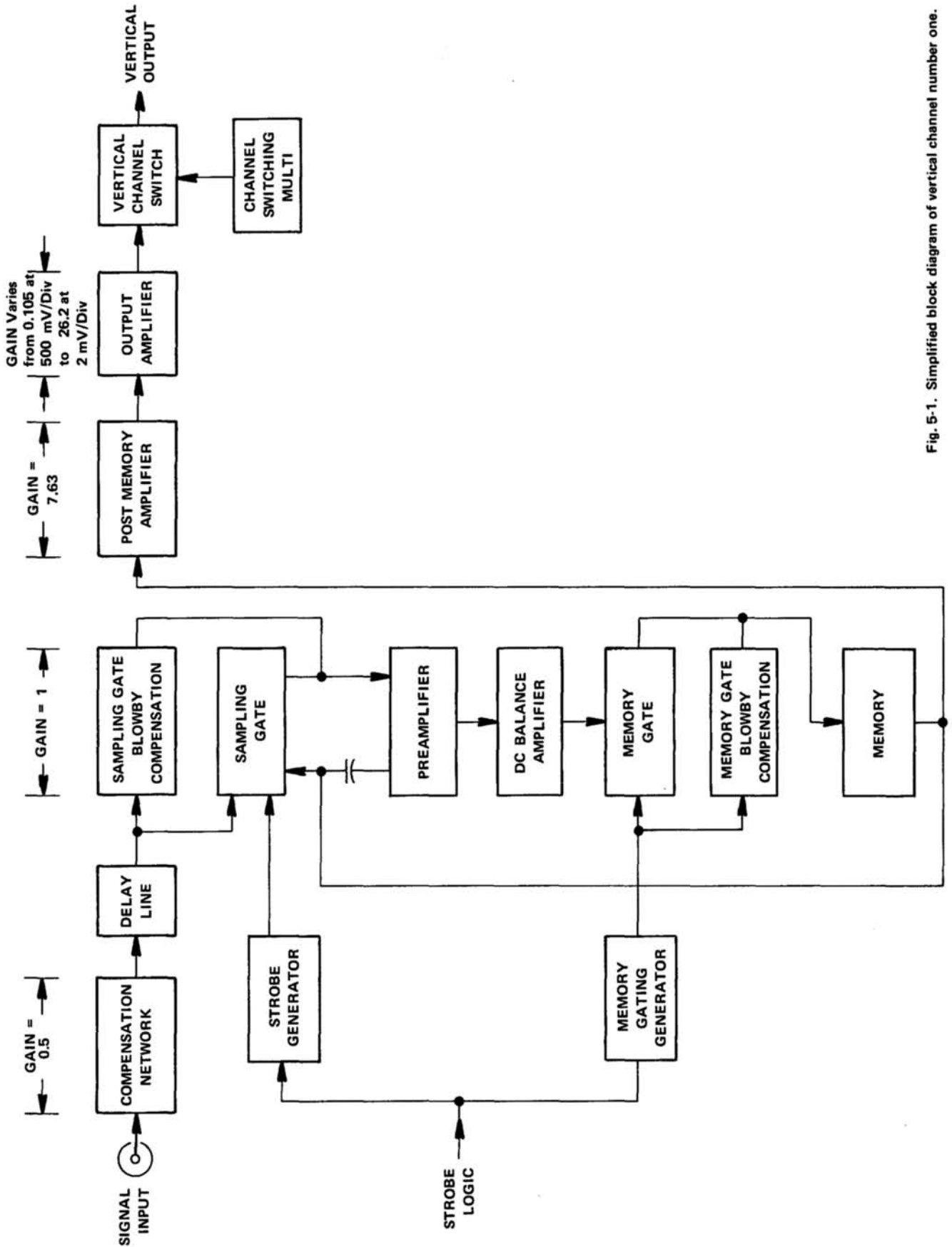

Fig. 5-1. Simplified block diagram of vertical channel number one.

Fig. 5-1. Simplified block diagram of vertical channel number one.

Holdoff Ramp Generator

The Holdoff Ramp Generator provides sweep signals to the Trigger circuit and determines the time between the sweeps.

The logic gate, consisting of diodes CR120, CR121, CR122, and CR123, senses the delaying sweep signal. When diodes CR120 and CR122 are turned on, diodes CR121 and CR123 are reverse biased, which causes transistor Q123 to be reverse biased and transistor Q124 to be turned on. In this condition, the Trigger circuit is waiting to accept a trigger signal. When a trigger signal is accepted, the delaying sweep runs down; when the delaying sweep is at its lowest level, delaying sweep transistor Q339 supplies current to the Holdoff Ramp Generator input, turning diode CR123 on and turning diode CR122 off. Diode CR120 is turned off and diode CR121 is turned on, therefore, current flowing through CR121 starts a negative-going holdoff ramp into holdoff capacitor C120. Transistor Q122 is turned on and Holdoff Schmidt U240C is returned to the holdoff condition (holdoff lockout occurs) and the Fast Ramp is returned to 0. Diode CR122 is now turned on, diodes CR121 and CR123 are turned off, and diode CR120 is turned on. The current source (Holdoff potentiometer) is passed through diode CR120, causing a positive holdoff ramp. When the holdoff turns transistor Q123 off, transistor Q124 is turned on. This puts Holdoff Schmidt U240C in the Hi state. This causes the Holdoff Lockout gates to revert; Delay gate U240A and Ramp Drive Lockout gate U260C accept a trigger signal. The time from the end of one sweep to the trigger of the next sweep is controlled by the Triggering Holdoff potentiometer R128.

Trigger Circuit

The Trigger Circuit is a logic network consisting of a Holdoff Schmidt, which is part of the Holdoff Ramp Generator circuit; the Reset and Arming Gates, which consist of the $C = \overline{A} \cdot \overline{B}$ gate and two Holdoff Lockout gates; two Delay gates; and two Ramp Drive Lockout gates. The Delay gates, $\overline{C} = A \cdot B$ gate, and the Holdoff Schmidt are contained in integrated circuit U240 and the Ramp Drive Lockout gate; the Holdoff Lockout gates are contained in integrated circuit U260. A simplified diagram is shown in Fig. 5-2 with each gate identified.

An output signal from the network occurs when the output level of the second Ramp Drive Lockout gate changes. This is caused by level changes to the inputs of the Holdoff Schmidt and the delay gate. The following is an example of how the logic of the Trigger Circuit may operate. The logic for this network is $C = \overline{A} \cdot \overline{B}$ and $\overline{C} = A + B$. Refer to Fig. 5-2 during this discussion.

Logic Example. With a negative signal to the input of the Holdoff Schmidt (U240C, pin 13), the output (pin 15) is

Hi, which means the inputs of U240D (pin 10) and U260B (pin 7) are Hi. The outputs U240D (pin 14) and U260B (pin 3) are therefore Lo, which means the inputs of U260A (pins 4 and 5) are Lo. The output of U260A (pin 2) must therefore be Hi, which means the inputs of U260B (pin 6), U260C (pin 12), and U240A (pin 5) are Hi, therefore, the outputs of U260C (pin 15) and U240A (pin 2) are Lo.

If we have a negative input to U240B (pin 6) and U240D (pin 11), the output of U240B (pin 3) must be Hi, which means the input of U240A (pin 4) is Hi. The output of U240A (pin 2) and therefore, the input of U260D (pin 11) is Lo. Since the output of U260C (pin 15) is Lo, the input of U260D (pin 10) must be Lo. With both inputs of U260D Lo, the output of U260D (pin 14) must be Hi, which means the input of U260C (pin 13) is Hi.

Now, if the input U240C (pin 13) goes positive, the output (pin 15) must go Lo, which makes the inputs of U240D (pin 10) and U260B (pin 7) Lo. Since both inputs of U240D (pins 10 and 11) are now Lo, the output (pin 14) must go Hi, which means the input of U260A (pin 5) is Hi. The output of U260A (pin 2) must go Lo, which makes the inputs of U260C (pin 12) and U240A (pin 5) Lo; however, since the inputs of U260C (pin 13) and U240A (pin 4) are Hi, there is no change to the outputs of U260C (pin 15) and U240A (pin 2), so there is no change in the output signal and consequently no output signal propagation.

If the input to U240B (pin 6) now goes Hi, the output of U240B (pin 3) must go Lo, which means the input of U240A (pin 4) is Lo. Since both inputs of U240A are now Lo, the output (pin 2) must go Hi, which makes the input of U260D (pin 11) Hi. The output of U260D (pin 14) must go Lo, which makes the input of U260C (pin 13) Lo. Since both inputs of U260C are now Lo, the output (pin 15) must go Hi. This is a level change at the Trigger Circuit output, therefore, an output signal is propagated.

Fast Ramps

There are two Fast Ramp generators; the Delaying Ramp Generator and the Delayed Ramp Generator. Each Ramp has a Comparator and a Ramp Inverter. The Ramp Inverters are driven by a 1-2-5 position Timing (SEC/DIV) switch. These Ramps generate a real time sweep to provide pulses to the Delta Delay Generator and the Buffer circuit.

The trigger signals to the Delaying Ramp Generator are held off by saturation transistor Q342, which is driven by transistor Q343. Transistor Q338 is the Delaying circuit Fast Ramp current source for the timing capacitors, C239, C241, C243, C244, and C252. The timing capacitors determine the rate of the signal. The sensing transistor Q339 clamps the negative excursions of the input signal. The Comparator consists of two comparator transistors,

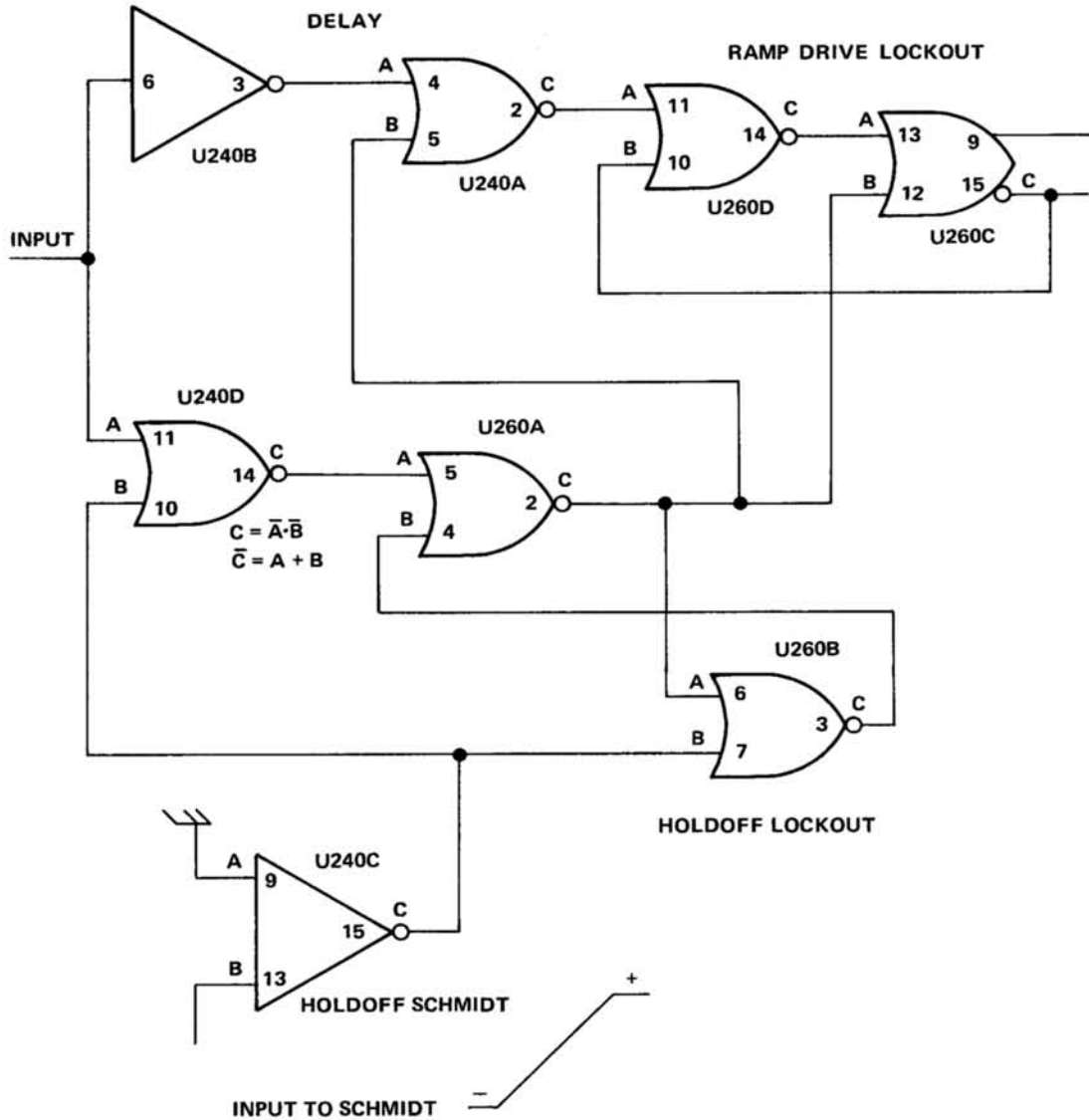

Fig. 5-2. Trigger Circuit Logic.

Q356 and Q357, with output provided by two line receivers, U455A and U455B. The level of the comparator transistors is determined by the Ramp Inverter U355, which is driven by the Timing switch. Resistor R230 is used to balance the input to the Inverter.

When Comparator transistor Q356 is on, transistor Q357 is off, therefore, the output (pin 2) of line receiver U455A is Hi and the output (pin 3) of line receiver U455B is Lo. At the comparison level, transistor Q357 is on and transistor Q356 is off. This makes the output (pin 3) of receiver U455B go positive and the output (pin 2) of receiver U455A go negative, which provides drive to the saturation transistor Q362 in the Delayed circuit.

The Delayed Fast Ramp Generator operates the same as the Delaying circuit, except that there is a tunnel diode (CR459) in the Comparator of the Delayed circuit that sharpens the delayed strobe output so that the output is independent of the ramp rate.

Delta Delay Generator

The Delta Delay Generator produces pulses that drive the Channel 1 Strobe Generator, Channel 2 Strobe Generator, and Memory Gating Generator. Two voltage comparators, contained in integrated circuit operational amplifier U470, make up the Delta Delay Generator.

One input to each of the two comparators is a reference voltage. The other input is a step from the delayed sweep circuit. When these two inputs are equal, the comparator produces an output pulse (comparator output rises). When the comparator input step ends, the comparator output falls and ends the output pulse.

Front panel CH 1 TIME DIFF CH 2 control R139 controls the comparator reference voltage. A change in this voltage changes the time when the two comparator output pulses start, relative to one another. This change, in turn, changes the time when the Channel 1 and Channel 2 Sampling Gates sample signals. A maximum of approximately 2 nanoseconds difference between the channels is possible.

Buffer

The Buffer circuit is a Schmidt with constant time feedback. It drives the Interdot Blanking Pulse Generator, Gating Generator and Scan Ramp Gating Multivibrator. In addition, it also drives the vertical Memory Gating Generator.

The Buffer consists of integrated circuit operational amplifiers U470A and U470B, and a capacitor C474 that determines the time constant for all trigger rates.

Scan Ramp Gating Multivibrator

The Scan Ramp Gating Multivibrator gates the Scan Ramp to generate equivalent time sweep. Among some of the functions performed by the Scan Ramp Gating Multivibrator are the sensing of sweep lockout, single sweep start, providing axis gating, and controlling the reset of the Scan Ramp and Staircase Generator.

The circuit consists of integrated circuit U390.

Interdot Blanking Pulse Generator

The Interdot Blanking Pulse Generator takes an output from the delayed strobe drive to create blanking and drive the alternating multivibrator signal. The circuit consists of a transistor Q590 and two capacitors C492 and C173.

Inverter, Gating Generator and Gated Current Generator

The Inverter is a multi-purpose operational amplifier, U490, which accepts an external scan ramp and provides an output either as a horizontal scan or as scan current to the Gated Current Generator. The Gating Generator takes output from the Buffer and provides drive to the Gated Current Generator by means of transistor Q480 and diode

CR480. The Gated Current Generator is a current generator that is gated by an inverter Q380. It provides an output signal to the Scan Ramp and Staircase Generator.

Scan Ramp and Staircase Generator

The Scan Ramp and Staircase Generator is an integrated circuit integrator with various ramps. The circuit is controlled by the Gated Current Generator and Scan Ramp Gating Multivibrator. When the circuit is in the Single Scan mode, it saturates at approximately 12 V. By pushing the START button, diode CR280 will be returned to its Lo state and the circuit can receive the next pulse.

The Scan Ramp and Staircase Generator circuit consists of integrated circuit U280, diode CR280, and two timing capacitors C280 and C281.

Two Dot Circuit

The Two Dot Circuit provides horizontal comparison for the two dots. The circuit contains the Two Dot Pulse and Delay Generator, Delay Voltage Follower, and 1st Dot Stop circuit.

The Two Dot Circuit produces two current sources through transistors Q139 and Q141. One source is for the delay multiplier stop and the other source is for calibration of the DELAY ZERO (1st DOT) and DELAY TIME MULT (2nd DOT) controls. The current sources are calibrated by variable resistors R130 and R131. The DELAY ZERO (1st DOT) control is adjustable over nine cm of the delaying sweep display, the DELAY TIME MULT (2nd DOT) control is adjustable over ten cm of display, and the time multiplier between the dots is read directly on the Delay Time Mult dial.

Input to the Two Dot Circuit is provided by the Scan Ramp and is compared against the voltages of the 1st and 2nd Dots. The comparator offset (dot width) is determined by resistor R161. As the Scan Ramp goes from 0 to 10 volts, the 1st and 2nd dot comparator inputs are traversed so that the first crossing turns the dot on and second crossing turns the dot off.

The 1st dot stop circuit is required to stop the 2nd dot from going beyond the right hand edge of the display; thus the reading on the dial is always correct.

The Delay Voltage Follower circuit consists of integrated circuit U145B. The Delay Generator consists of the integrated circuit U145A, variable resistor (1st dot stop control) R130, diode CR150, transistors Q139, Q141, Q142, and Q143. The Two Dot Pulse circuit consists of integrated circuits U150 and U155.

Circuit Description—7S14

Intensity Blanking Mixer

The Intensity Blanking Mixer is a circuit that intensifies each dot width received from the Two Dot circuit and provides blanking during the time the sampler is taking a new sample.

Transistor Q160 is used to intensify the dot and transistor Q161 is the blanking transistor in the Intensity Blanking Mixer circuit.

Position Voltage Follower and Horizontal Amplifier

The Position Voltage Follower is the operational amplifier U180A used as the horizontal position calibrator. Input current to the Voltage Follower is provided by variable resistor R100. The output of the Position Voltage Follower and the horizontal drive current are summed by the the Horizontal Amplifier. The selection of the Vertical Mode Switch determines the drive (sawtooth or X from Channel 2 Vertical Amplifier) to the Horizontal Amplifier. The Horizontal Amplifier is an operational amplifier U180B that provides input to the Sweep Calibrator R183.

Readout

Readout Logic is provided to the oscilloscope readout circuitry by signals from the readout board. The logic to the readout board comes from the Channel 1 and Channel 2 attenuator switches of the vertical section and from the Delaying Sweep and Delayed Sweep sections of the Timing switch of the horizontal section.

The Readout logic is shown on schematics 3 and 5C in Section 9 of the manual. For more specific information on the readout circuitry, refer to the Circuit Description section of your Tektronix 7000 Series oscilloscope manual.

Horizontal Power

The power to the Horizontal section of the 7S14 is supplied by the vertical section of the 7S14 and the mainframe of the 7000 series instrument used. The Power Distribution is shown on schematics 9A and 9B at the rear of the manual.

MAINTENANCE

Introduction

This section of the manual provides information used for preventive maintenance, corrective maintenance, and troubleshooting the 7S14. The physical location of all circuit components on the circuit boards are shown in full size illustrations at the rear of this section.

PREVENTIVE MAINTENANCE

General

Preventive maintenance consists of cleaning, visual inspection, lubrication, etc. Preventive maintenance performed on a regular basis will help prevent instrument failure and will improve reliability of the instrument. The severity of the environment to which the 7S14 is subjected determines the frequency of needed maintenance. A convenient time to perform preventive maintenance is preceding recalibration of the instrument.

Cleaning

Accumulation of dirt in the instrument can cause overheating and component breakdown. Dirt on components acts as an insulating blanket and prevents efficient heat dissipation. It also provides an electrical conduction path.

The side panels of the 7S14 provide protection against dust in the interior of the instrument. Operating without the covers in place will create the need for more frequent cleaning.

CAUTION

Avoid the use of chemical cleaning agents which might damage the plastics used in this instrument. Avoid chemicals which contain benzene, toluene, xylene, acetone or similar solvents.

Exterior. Loose dust accumulated on the outside of the 7S14 can be removed with a soft cloth or small paint brush. The paint brush is particularly useful for dislodging dirt on and around the front-panel controls. Dirt that remains can be removed with a soft cloth dampened with a mild detergent and water solution. Abrasive cleaners should not be used.

Interior. Dust in the interior of the instrument should be removed occasionally, due to its electrical conductivity under high-humidity conditions. The best way to clean the interior is to blow off the accumulated dust with dry, low-pressure air. Remove any dirt that remains with a soft paint brush or a cloth dampened with a mild detergent and water solution. A cotton-tipped applicator is useful for cleaning in narrow spaces on circuit boards.

Lubrication

The reliability of potentiometers, switches and other moving parts can be maintained if they are kept properly lubricated. However, too much lubricant is as detrimental as too little lubricant. A lubrication kit containing the necessary lubricants and instructions is available from Tektronix, Inc. Order Tektronix Part Number 003-0342-02.

Visual Inspection

The 7S14 should be inspected occasionally for such defects as broken connections, damaged circuit boards, improperly seated transistors or pin connectors, frayed cable shields and heat-damaged components.

The corrective procedures for most visible defects are obvious; however, particular care should be taken if heat damaged components are found. Overheating usually indicates other trouble in the instrument; therefore, it is important that the cause of overheating be corrected to prevent recurrence of the damage.

Semiconductor Checks

Periodic checks of the semiconductors in the 7S14 are not recommended. The best check of semiconductor performance is actual operation in the instrument. More details on checking semiconductor operation are given under troubleshooting.

Recalibration

To ensure accurate measurements, check the calibration of the 7S14 after each 500 hours of operation or every six months if used infrequently. In addition, replacement of components may necessitate recalibration of the affected circuits. The calibration procedure can also be helpful localizing certain troubles in the instrument. In some cases, minor troubles may be revealed or corrected by recalibration.

TROUBLESHOOTING

Introduction

The following information is provided to facilitate troubleshooting of the 7S14. Information contained in other sections of this manual should be used along with the following information to aid in locating the defective component. An understanding of the circuit operation is helpful in locating troubles. See the Circuit Description section for information.

Troubleshooting Aids

Diagrams. Circuit diagrams and corresponding circuit boards are located on foldout pages at the rear of the manual. Preceding the circuit diagrams is Section 8 of the manual, which contains the Electrical Parts List. From these schematics and the parts list the component number, location, electrical characteristics and Tektronix, Inc. part number can be cross referenced. The components that are located on the front panel are shown on the circuit diagrams with their front-panel names given in a block. The names of the internally adjustable components are also given, but the names are not in blocks. Additional aids for troubleshooting can be found in the Calibration section of this manual. By performing the checks as described in the Calibration section, an individual can often isolate where the trouble exists.

Cam Switch Contact Identification. Switches shown on diagram 5_c are coded to indicate the position of the contact in the switch assembly counting from the front, or mounting end of the switch, toward the rear. The contact closure chart given on the diagram indicates when each contact is closed.

Circuit Boards. Fig. 6-12 through 6-21 show the circuit boards used in the 7S14. These pictures, used along with the circuit diagrams, aid in locating the component mounted on the circuit boards.

Component Identification

The electrical components in the 7S14 are identified either with a printed identification or EIA color code marking. For components that do not lend themselves to marking, refer to the parts list for information.

Resistors. The 7S14 uses composition and metal film resistors in its circuits. Most of these resistors will be color coded although a few may be marked using printing. Composition resistors are color coded using a four band system where the first two bands represent value significant figures, the third band is the multiplier, and the fourth

band is the tolerance. Metal film resistors are color coded with a five band system where the first three bands represent value significant figures, the fourth band is the multiplier and the fifth band is the tolerance.

Capacitors. Most capacitors have the value printed on the body of the component. However, some of the smaller capacitors and some of the new tantalum capacitors are color coded. There are several varieties of color code systems used, so for absolute identification, it is best to refer to the parts list.

Semiconductor Devices. Most semiconductor devices will have the identification printed on the body of the device. The information will indicate the Tektronix, Inc. part number, the manufacturers part number or the JEDEC part number assigned to the device. Some of the glass diodes are color coded. If a diode is color coded, the first band is the cathode indicator. The next three bands will represent the middle three numbers of the Tektronix, Inc. part number or the last three numbers of the JEDEC part number.

Semiconductor Lead Configuration. Fig. 6-1 shows the lead configuration for the transistors and the integrated circuits used in the 7S14. Orientation for the integrated circuits is indicated by a dot located next to the socket on the circuit board where the number 1 pin of the integrated circuit is to be located.

Troubleshooting Equipment

The following equipment is useful for troubleshooting the 7S14.

1. Transistor Checker

Description: Dynamic-type tester.

Purpose: To test the semiconductors used in this instrument.

Recommended type: Tektronix 576 Curve Tracer.

2. Voltohmmeter

Description: 0 to 50 megohms. Accuracy, within 3%. Test probes must be insulated to prevent accidental shorting.

Purpose: For general troubleshooting. Do not use a VOM for absolute resistance check of precision resistors.

NOTE

A 20,000 ohms/volt VOM can be used to check the voltages in this instrument if allowances are made for the circuit loading of the VOM at high-impedance points.

NOTE
LEAD CONFIGURATIONS AND CASE STYLES ARE TYPICAL, BUT MAY VARY DUE TO VENDOR CHANGES OR INSTRUMENT MODIFICATIONS.

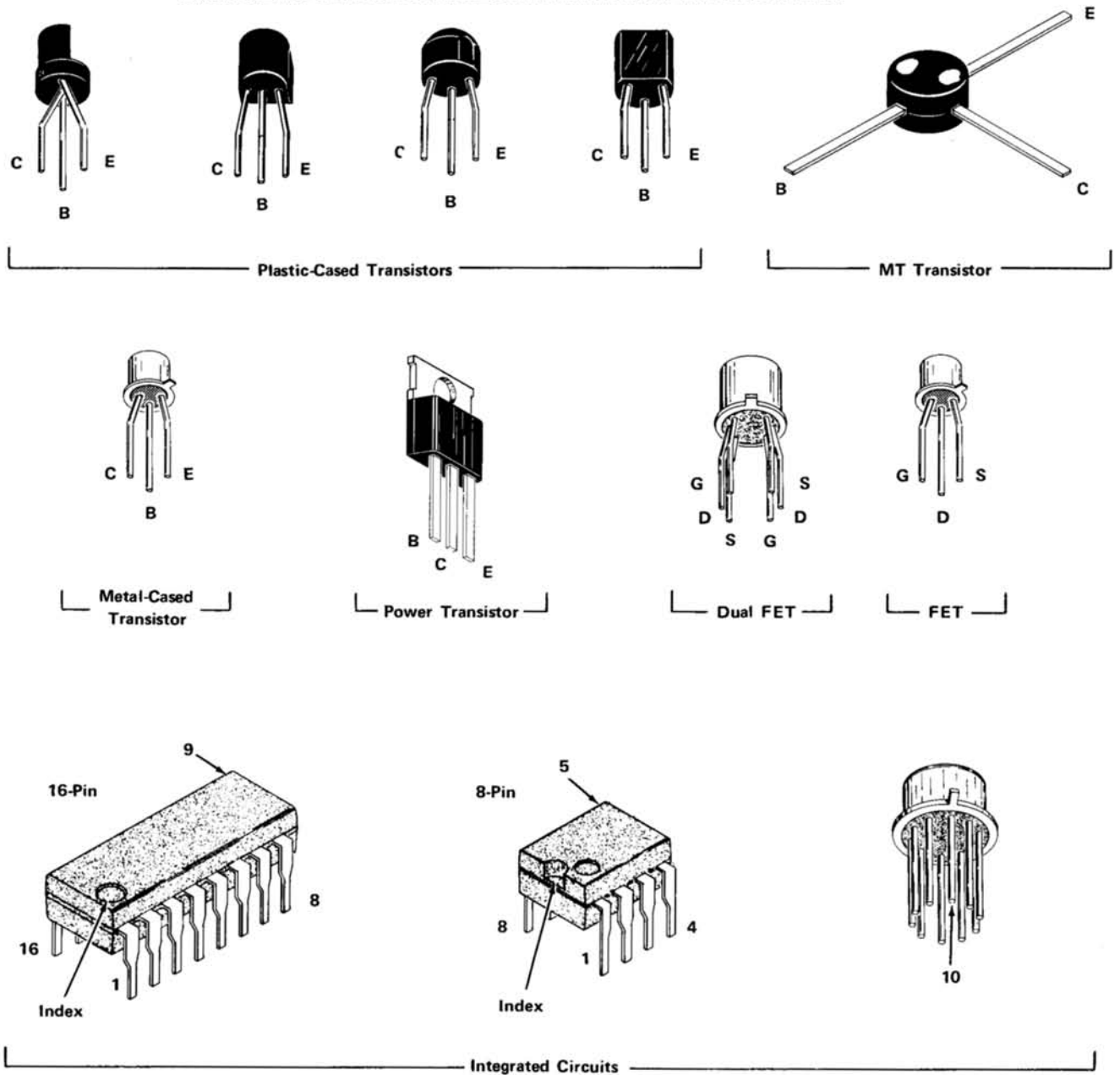

Fig. 6-1. Transistor and integrated circuit pin arrangement.

1409-01

3. Test Oscilloscope

Description: Frequency response, DC to 10 MHz minimum; deflection factor, 100 millivolts to 2 volts/division, and .5 microseconds to 10 milliseconds/division. Use a 1X voltage probe.

Purpose: To check the operating waveforms of the 7S14.

Recommended type: Tektronix 7000 series oscilloscope with a 7A13 Amplifier and 7B50 or 7B70 Time Base. Use a P6011 probe.

Troubleshooting Techniques

This troubleshooting procedure is arranged in an order that checks the simple trouble possibilities before proceeding with extensive troubleshooting. The first few checks assure proper connection, operation and calibration. If the trouble is not located by these checks, the remaining steps aid in locating the defective component. When a defective component is located, it should be replaced following the replacement procedures given under Corrective Maintenance.

1. Check Control Settings. Incorrect control settings can indicate a trouble that does not exist. If there is any question about the correct function or operation of any control, see the Operating Instructions section.

2. Check Associated Equipment. Before proceeding with troubleshooting of the 7S14, check that the equipment used with this instrument is operating correctly. Check that the signal is properly connected and that the interconnecting cables are not defective. Also, check the power source.

3. Visual Check. Visually check the instrument for such problems as unsoldered connections, broken wires, damaged circuit boards, damaged components, etc.

4. Check Instrument Calibration. Check the calibration of this instrument, or the affected circuit if the trouble appears in one circuit. The apparent trouble may only be a result of misadjustment, which can be corrected by calibration. Complete calibration instructions are given in the Calibration section.

5. Isolate Trouble to a Circuit. To isolate trouble to a particular circuit, note the trouble symptom. The symptom often identifies the circuit in which the trouble is located. When trouble symptoms appear in more than one circuit, check affected circuits by taking voltage and waveform readings. See the information under Troubleshooting Procedure in this section for the recommended method of troubleshooting the circuits of the 7S14.

6. Check Individual Components. The following paragraphs describe methods of checking individual components in the 7S14. Components that are soldered in place are best checked by first disconnecting one end. This isolates the measurement from the effects of surrounding circuitry.

NOTE

In order to check components on the Sampler Boards, it is necessary to remove the Sampler Board Cover. The 7S14 may still be operated by replacing the cover with a test fixture, Tektronix Part Number 067-0693-00. It requires two of these test fixtures for both channels to be operational at the same time.

A. SEMICONDUCTORS



If the 7S14 is connected to the mainframe with extender cables, turn the power switch off before removing or replacing semiconductors.

A good check of transistor operation is actual performance under operating conditions. A transistor can most effectively be checked by substituting a new component for the one in question (it is recommended that the replacement part be one that has been tested). However, be sure that the circuit conditions are not such that a replacement transistor might also be damaged. If substitute transistors are not available, use a dynamic tester to check the transistor in question. Static-type tester are not recommended, since they do not check operation under simulated operating conditions.

Integrated circuits can be checked with a voltmeter, test oscilloscope, or by direct substitution. A good understanding of the circuit description is essential to troubleshooting circuits that contain integrated circuits. In addition, checking for the circuits to produce operating waveforms, as shown in the schematic section, is a good operational check for integrated circuits. Use care when checking integrated circuits so that leads do not get shorted together.

B. DIODES

A diode can be checked for an open or shorted condition by measuring the resistance between terminals. With an ohmmeter scale having an internal source of between 800 millivolts and 3 volts, the resistance should be very high in one direction and very low when the meter leads are reversed.



Do not use an ohmmeter scale that has a high internal current; high currents may damage the diode.

A test instrument such as a 576 Curve Tracer is good for checking the actual parameters of diodes.

8. Repair and Readjust the Circuit. If any defective parts are located, follow the replacement procedures given in this section. Be sure to check the performance of any circuit that has been repaired or that has had any electrical components replaced.

Troubleshooting Procedure

General. The following procedure explains a logical step-by-step test sequence to be followed when troubleshooting the 7S14. A typical waveform for each test point is shown. If you do not get a waveform similar to the one shown for the test point being checked, the components associated with that test point (see the schematics for applicable components) should be checked. If the components in the Samplers have to be checked, the sampler cover has to be removed. The instrument may still be operated by

replacing the sampler cover with test fixture 067-0693-01. Two of these test fixtures are required if you want to operate both channels at the same time.

Any general purpose oscilloscope with a minimum bandwidth of 10 MHz can be used as a test oscilloscope for troubleshooting the 7S14. The ensuing test procedure was performed using a Tektronix 7704 oscilloscope with a 7A13 Amplifier and a 7B71 Time Base. By using this set-up the included waveform pictures contain readout showing the vertical sensitivity and sweep rate for each test.

It is recommended that the power supplies be checked before proceeding with the waveform checks to ensure that the mainframe and the 7S14 power supplies are in operating condition. A procedure for testing the power supplies is given in the PERFORMANCE CHECK section of the manual.

Test Procedure. This test procedure will give the initial set-up for the 7S14 Sampler, the 284 Pulse Generator and the test oscilloscope. After that, only the pertinent changes to the set-up will be given. Since the test oscilloscope used to perform these checks may vary, only the general requirements for the test oscilloscope set-up will be given.

7S14 Initial Set-up

Donnect the 7S14 to the 7000 series mainframe using a set of extender cables (067-0616-00). Remove the side panels from the 7S14.

CH 1 & CH 2 VOLTS/ DIV controls	Set to .5 V
DELAYING SWEEP SEC/DIV	Set to 1 μ s
DELAYED SWEEP SEC/DIV	Set to 1 μ s
All red CAL controls	Set fully CCW (in detent)

The following push-buttons must be pushed in: CH 1 + SLOPE, and REP. All other push buttons must be released.

284 Pulse Generator Initial Set-up

SQUARE WAVE AMPLITUDE	Set to 1.0 V
PERIOD	Set to 1 μ s
MODE	Set to SQUARE WAVE OR SINE WAVE OUTPUT

Connect a 50 Ω coaxial cable from the 284 SQUARE WAVE OR SINE WAVE OUTPUT connector to the 7S14 EXT INPUT 50 Ω connector.

Test Oscilloscope Initial Set-up

Amplifier VOLTS/DIV	Set to 500 mV
TIME/DIV	Set to 500 ns
Vertical	DC Coupled
Source	Internal

Attach a 1X probe to the amplifier input.

A. HORIZONTAL CHECKS

1. Connect the 1X Amplifier probe to Pin F of the 7S14 Trigger board with the probe ground clip attached to the 7S14 chassis. Adjust the 7S14 TRIGGERING control for a free-running trace on the 7000 series mainframe. Trigger the test oscilloscope for a waveform display. This waveform should be similar to that shown in Fig. 6-2A. If the waveform is not as shown or no waveform appears, check the appropriate circuitry (see schematics in Section 9).

2. Change the test oscilloscope vertical to 2 V/Div. Move the probe to Pin 11 of U220 on the Trigger board. Trigger the test oscilloscope for a waveform. This waveform should be similar to that shown in Fig. 6-2B.

3. Move the probe to Pin 2 of U220 on the Trigger board. Trigger the test oscilloscope for a waveform. This waveform should be similar to that shown in Fig. 6-2C.

4. Change the test oscilloscope Time/Div to 20 μ s. Connect the probe to Pin K of the Trigger board. Trigger the test oscilloscope for a waveform. This waveform should be the same as that shown in Fig. 6-2D.

5. Move the probe to Pin L of the Trigger board. The waveform should be the same as that shown in Fig. 6-2E.

6. Connect the probe to Pin C of the Trigger board. Trigger the test oscilloscope for a waveform. This waveform should be the same as that shown in Fig. 6-2F.

7. Perform the 7S14 High Frequency check in the following manner:

a. Change the 7S14 CH 1 VOLTS/DIV to 50 mV.

b. Set both the DELAYING and DELAYED SWEEP controls of the 7S14 to 10 ns.

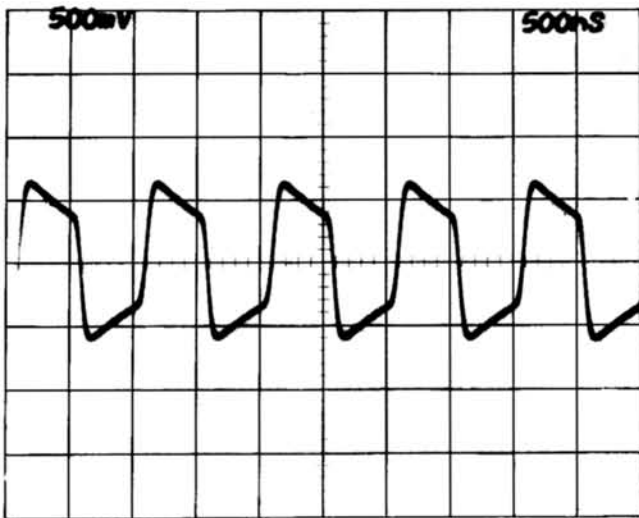

(A) Probe to pin F.

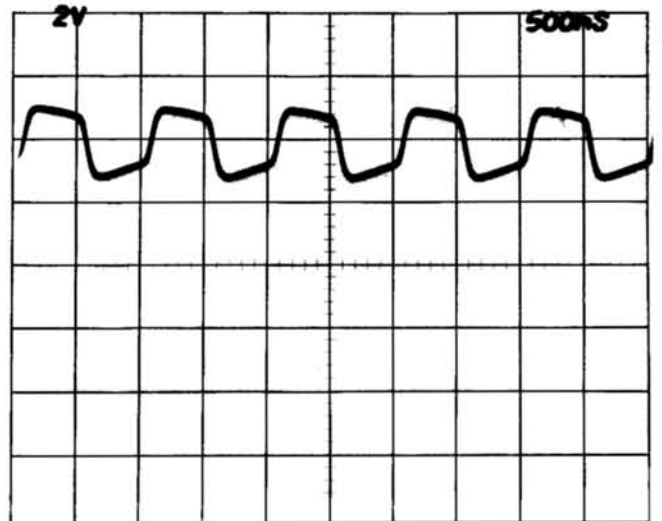

(B) Probe to U220, pin 11.

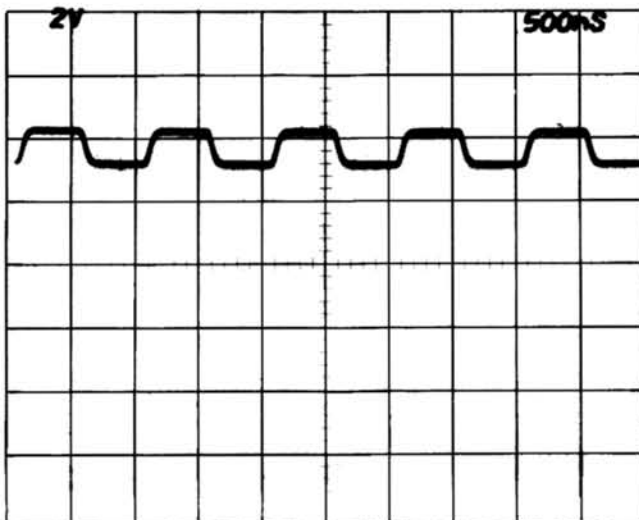

(C) Probe to U220, pin 2.

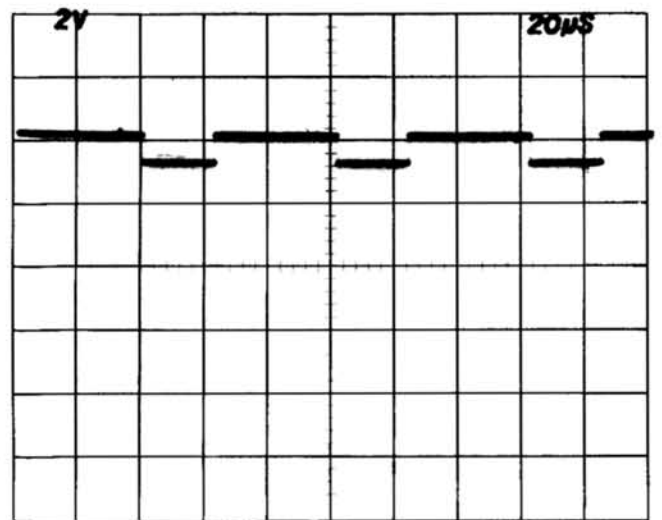

(D) Probe to pin K.

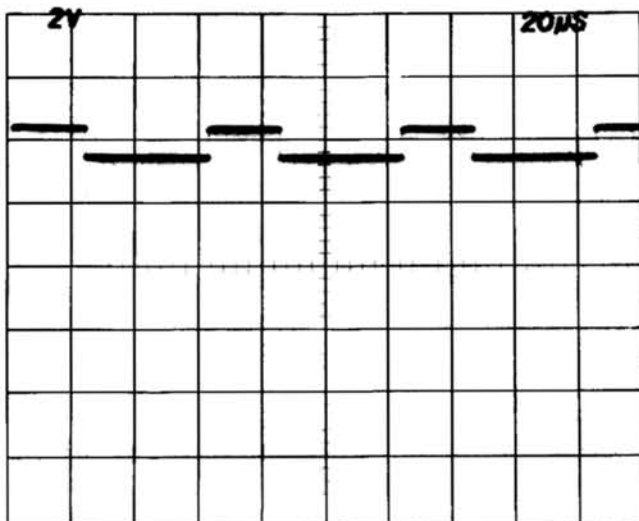

(E) Probe to pin L.

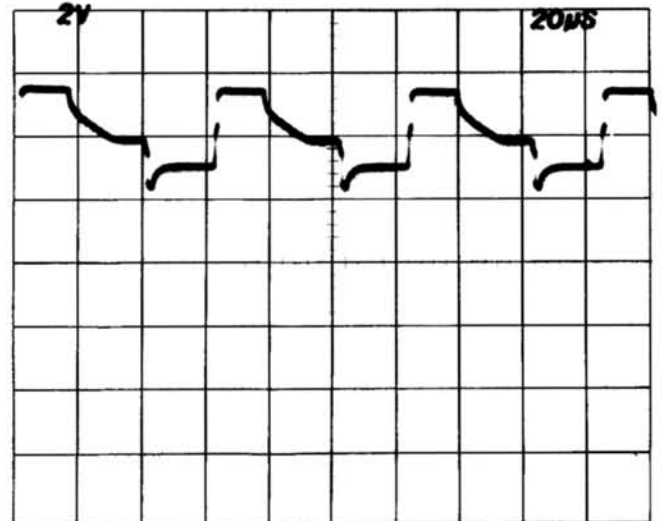

(F) Probe to pin C.

Fig. 6-2. Trigger waveforms.

c. The following 7S14 push-buttons are to be pushed in: INT CH 1, HF SYNC, CH 1, + SLOPE, and REP. All other push-buttons are out.

d. Set the 284 PERIOD to 10 ns.

e. Attach 50 Ω coaxial cable from 284 SQUARE WAVE OR SINE WAVE OUTPUT to the 7S14 CH 1 INPUT.

It should now be possible to obtain a waveform on the mainframe graticule by adjusting the 7S14 TRIGGERING control.

8. Disconnect the 1X test probe from the 7S14. Change the 284 PERIOD control to 1 μ s. Connect a second 50 Ω coaxial cable from the 284 to the 7S14 with this cable from the 284 TRIGGER OUTPUT to the 7S14 EXT INPUT. Release the INT CH 1 and HF SYNC push-buttons on the 7S14, leaving the CH 1, + SLOPE, and REP buttons pushed in. Change both the DELAYING and DELAYED SWEEPS of the 7S14 to 1 μ s. Change the 7S14 CH 1 VOLTS/DIV to .5 V. Use the 7S14 TRIGGERING control to trigger a display on the 7S14 mainframe. Change the test oscilloscope Amplifier to 1 V/Div. Set a 0 V reference on the test oscilloscope, 1 cm above the bottom graticule line on the oscilloscope.

9. Connect the Amplifier 1X probe to Pin 6 of U455 on the Horizontal board and trigger the test oscilloscope for a waveform. This waveform should be similar to that shown in Fig. 6-3.

10. Change the test oscilloscope Amplifier to 2 V/Div and move the 0 V reference to the Horizontal centerline. Connect the probe to Pin 5 of U455 on the Horizontal board. Trigger the test oscilloscope for a waveform. This waveform should be similar to that shown in Fig. 6-4.

11. Connect the probe to the collector lead of Q355 on the Horizontal board. Trigger the test oscilloscope for a waveform. This waveform should be similar to that shown in Fig. 6-5.

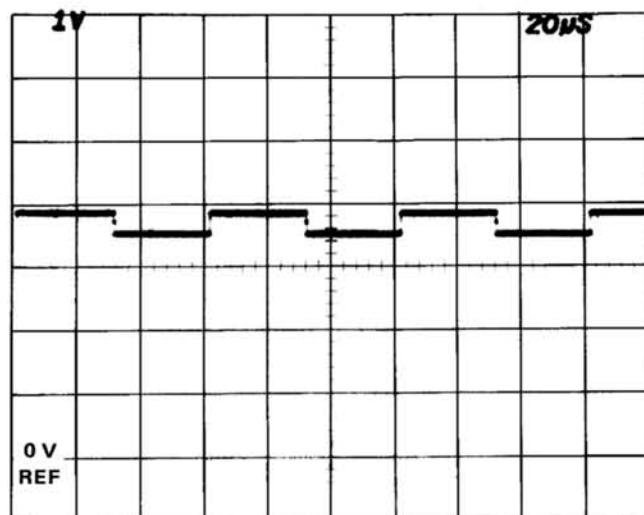

Fig. 6-3. Probe to Pin 6 of U455.

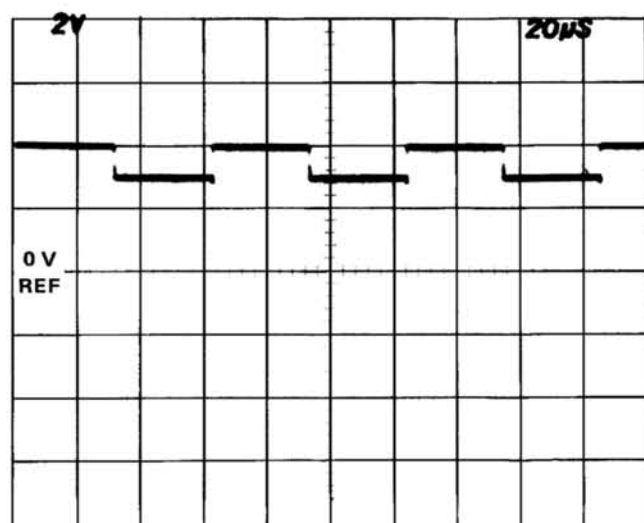

Fig. 6-4. Probe to Pin 5 of U455.

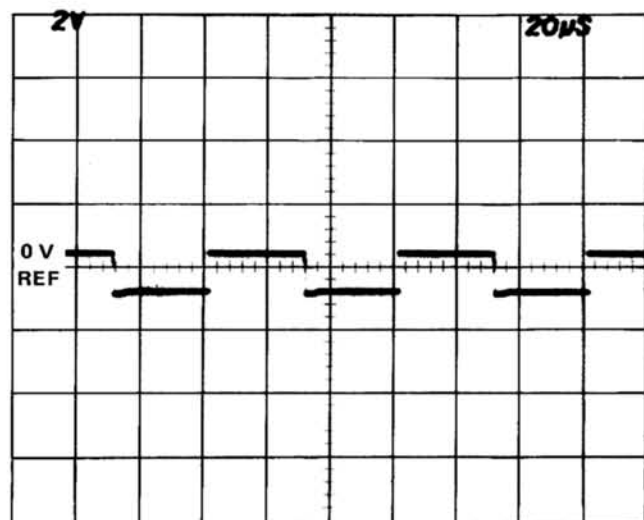

Fig. 6-5. Probe to Collector lead of Q355.

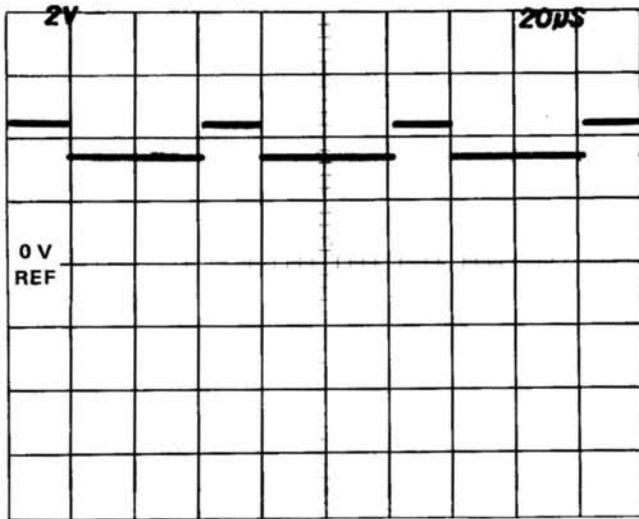

Fig. 6-6. Probe to Pin 15 of U455 or Pin 15 of U470.

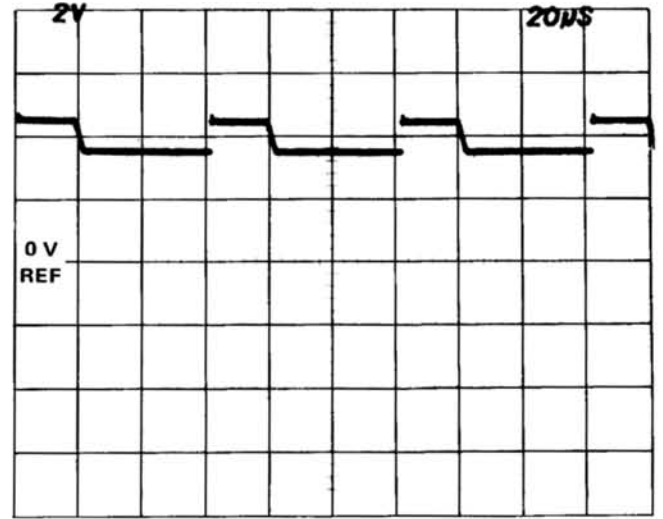

Fig. 6-7. Probe to Pin 14 of U470.

12. Push the 7S14 MAN button in. Move the probe to Pin 15 of U455 on the Horizontal board. Trigger the test oscilloscope for a waveform similar to that shown in Fig. 6-6.

13. Move the probe to Pin 15 of U470 on the Horizontal board. Trigger the test oscilloscope for a waveform similar to that shown in Fig. 6-6.

14. Move the probe to Pin 14 of U470 on the Horizontal board. Trigger the test oscilloscope for a waveform similar to that shown in Fig. 6-7.

15. Move the probe to Pin 3 of U470 on the Horizontal board. Trigger the test oscilloscope for a waveform similar to that shown in Fig. 6-8.

16. Push the 7S14 REP button (MAN button released). Change the test oscilloscope Amplifier to .1 V/Div and change the Time Base to 10 ms/Div. Move the probe to Pin 9 of U280 on the Horizontal board. Trigger the test oscilloscope for a waveform similar to that shown in Fig. 6-9.

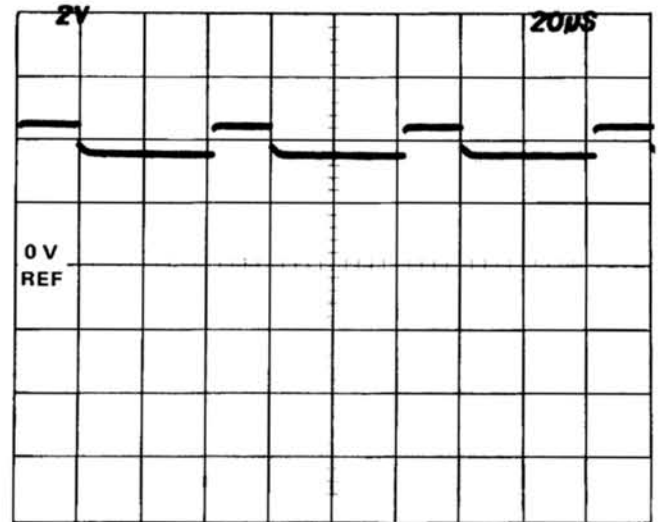

Fig. 6-8. Probe to Pin 3 of U470.

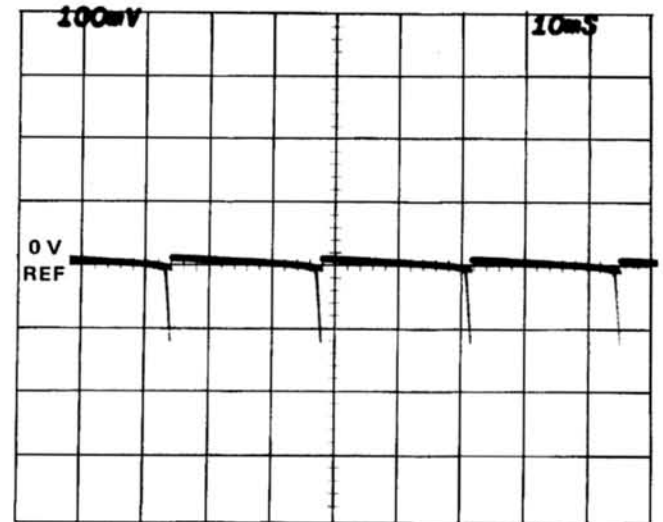

Fig. 6-9. Probe to Pin 9 of U280.

17. Change the test oscilloscope Amplifier to 2 V/Div and the Time Base to 5 ms/Div. Set the 0 V reference point 1 cm above the lowest graticule line of the test oscilloscope. Connect the probe to Pin 8 of U280 on the Horizontal board. Trigger the test oscilloscope for a waveform similar to that shown in Fig. 6-10.

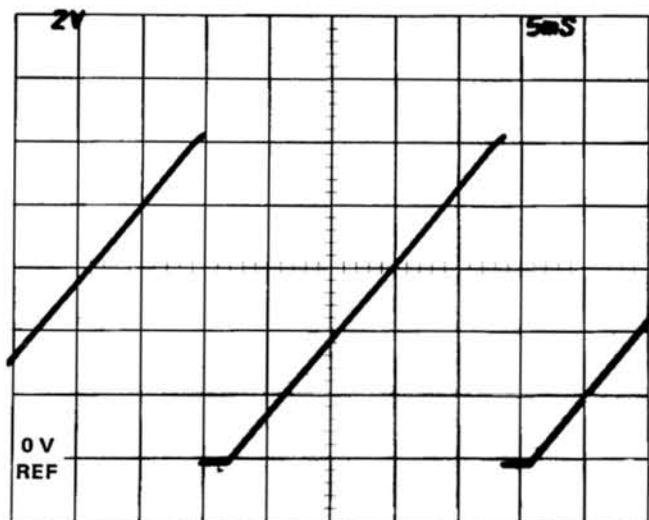

Fig. 6-10. Probe to Pin 8 of U280.

18. Remove the test probe from the 7S14. Push the 7S14 SWP button, set the DELAY ZERO (1st DOT) control completely counterclockwise, and set the DELAY TIME MULT (2nd DOT) control to 8.0. Turn the 7000 Series Mainframe INTENSITY control down until two bright dots can be seen. Adjust the 7S14 DELAY ZERO (1st DOT) control until the first dot is located on the first graticule line. There should be 2 dots on the screen approximately 8 cm apart.

B. VERTICAL CHECKS

19. Increase the 7S14 MAINFRAME INTENSITY control until the waveform is distinct. Change the 284 SQUARE WAVE AMPLITUDE to 100 mV. Change the 7S14 CH 1 and CH 2 VOLTS/DIV controls to .1 V. Change the test oscilloscope Amplifier to .1 V/Div. Change the test oscilloscope Time Base to 2 ms/Div.

20. Connect the 1X Probe to Test Point 1 (TP 1) on the 7S14 Vertical board. Trigger a waveform on the test oscilloscope similar to that shown in Fig. 6-11A.

21. Move the probe to TP 2 on the Vertical board. Trigger a waveform on the test oscilloscope similar to that shown in Fig. 6-11B.

22. Move the probe to TP 3 on the Vertical board. This waveform must be similar to that shown in Fig. 6-11B.

23. Move the probe to TP 4 on the Vertical board. Trigger a waveform on the test oscilloscope similar to that shown in Fig. 6-11C.

24. Move the probe to TP 6 on the Vertical Board. Trigger a waveform on the test oscilloscope similar to that shown in Fig. 6-11D.

25. Move the coaxial cable from the CH 1 INPUT to the CH 2 INPUT of the 7S14. Push the 7S14 CH 2 push-button.

26. Move the probe to TP 7 on the Vertical board. Trigger a waveform on the test oscilloscope similar to that shown in Fig. 6-11A.

27. Move the probe to TP 10 on the Vertical board. Trigger a waveform on the test oscilloscope similar to that shown in Fig. 6-11B.

28. Move the probe to TP 8 on the Vertical board. Trigger a waveform on the test oscilloscope similar to that shown in Fig. 6-11B.

29. Move the probe to TP 11 on the Vertical board. Trigger a waveform on the test oscilloscope similar to that shown in Fig. 6-11C.

30. Move the probe to TP 13 on the Vertical board. Trigger a waveform on the test oscilloscope similar to that shown in Fig. 6-11D.

31. Move the probe to TP 12 (Unity Gain) on the Vertical board. Trigger a waveform on the test oscilloscope similar to that shown in Fig. 6-11E.

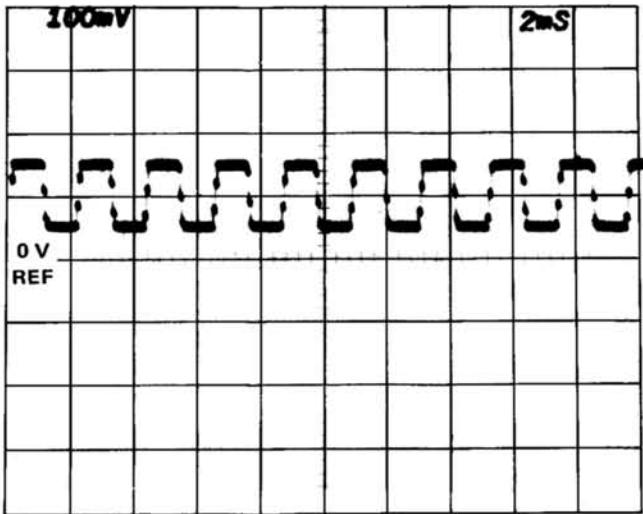

(A) Probe at TP1 or TP7.

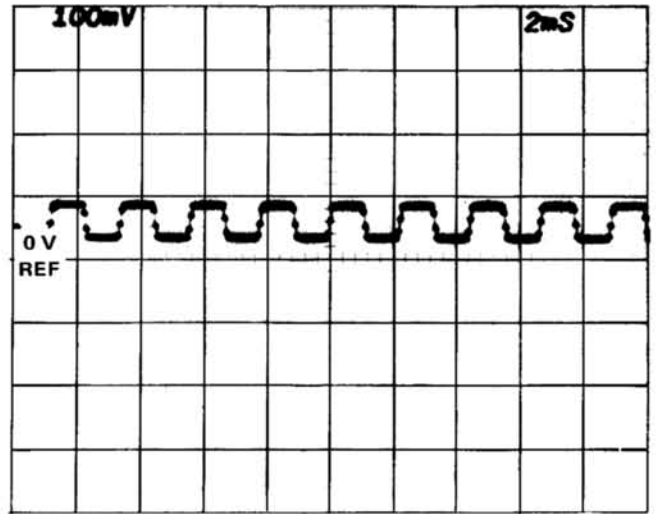

(B) Probe at TP2, TP3, TP8, or TP10.

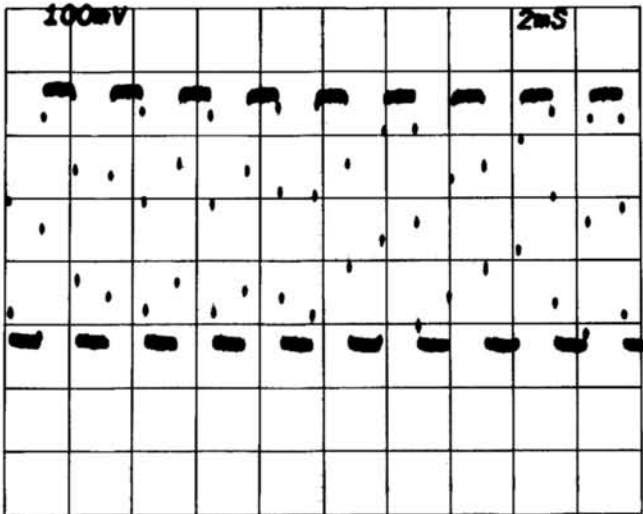

(C) Probe at TP4 or TP11.

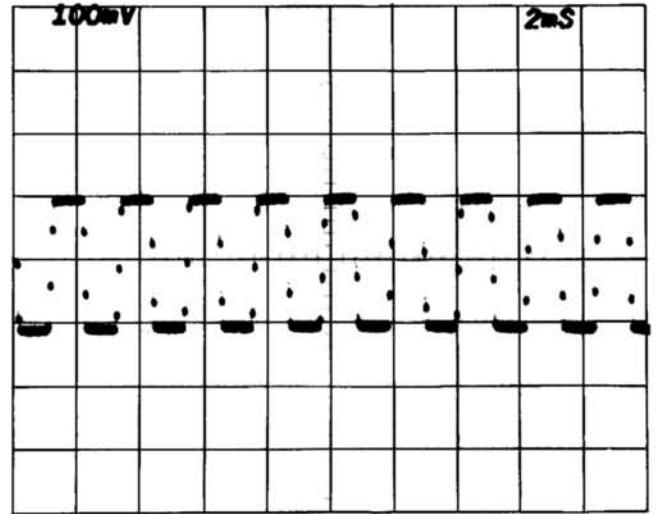

(D) Probe at TP6 or TP13.

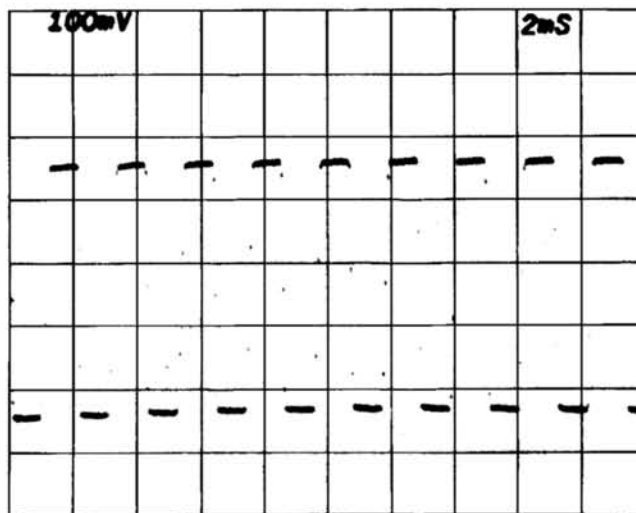

(E) Probe at TP12.

Fig. 6-11. Vertical waveforms.

CORRECTIVE MAINTENANCE

General

Corrective maintenance consists of component replacement, circuit board replacement and instrument repair. Special techniques required to replace components and circuit boards in this instrument are given here. The circuit board photographs at the end of this section, the Electrical Parts List (Section 8), the Circuit Diagrams (Section 9), and the exploded-view drawings with associated Mechanical Parts List (Section 10) may be helpful in the removal and replacement of components and circuit boards as described in this section.

Obtaining Replacement Parts

Standard Parts. All electrical and mechanical parts used in the 7S14 can be obtained through your local Tektronix Field Office or representative. However many of the standard electronic components can be obtained locally in less time than is required to order them from Tektronix, Inc. Before purchasing or ordering replacement parts, check the parts lists for value, tolerance, rating, and description. The parts list also lists a manufacturer's code and manufacturer's part number. A cross-index on page 8-2 identifies the manufacturer's.

NOTE

When selecting replacement parts, it is important to remember that the physical size and shape of a component may affect the performance in the instrument, particularly at high frequencies. All replacement parts should be direct replacements, unless it is known that a different component will not adversely affect instrument performance.

Special Parts. In addition to the standard electronic components, some special components are used in the 7S14. These components are manufactured or selected by Tektronix, Inc. to meet specific performance requirements, or are manufactured for Tektronix, Inc. in accordance with our specifications. These special components are indicated in the Electrical Parts List by manufacturer's code number 80009. Most of the mechanical parts used in this instrument have been specifically manufactured for Tektronix, Inc. Order all special parts directly from your local Tektronix Field Office or representative.

Ordering Parts. When ordering replacement parts from Tektronix, Inc., include the following information:

1. Instrument type.
2. Instrument serial number.
3. A description of the part (if electrical, include the circuit number).
4. Tektronix Part Number.

Soldering Techniques

WARNING

Disconnect the instrument from the power source before soldering.

Circuit Boards. Use ordinary 60/40 solder and a 35 to 40 watt pencil type soldering iron on the circuit boards. (A higher wattage soldering iron may separate the wiring from the base material.) The tip of the iron should be clean and properly tinned for best heat transfer to the solder joint.

The following technique should be used to replace a component on a circuit board. Use the procedures explained under Component Replacement to remove the boards from the instrument before soldering.

1. Hold the component lead with a pair of long-nose pliers. Touch the soldering iron to the lead at the solder connection. Do not lay the iron directly on the board, since it may damage the board.

2. When the solder begins to melt, pull the lead out gently. This should leave a clean hole in the board. If not, the hole can be cleaned by reheating the solder and placing a sharp object such as a toothpick into the hole to clean it out. A vacuum-type desoldering tool can also be used for this purpose.

3. Bend the leads of the new component to fit the holes in the board. Insert the leads into the holes in the board so that the component is firmly seated against the board, or as originally positioned. If it does not seat properly, heat the solder and gently press the component into place.

4. Touch the iron to the lead and apply a small amount of solder to make a firm solder joint; do not apply excessive solder. To protect heat-sensitive components, hold the lead between the body and the solder joint with either a pair of long-nose pliers or some other heat-sink.

5. Clip the excess lead that protrudes through the board.

6. Clean the area around the solder connection with a flux-remover solvent. Be careful not to remove information printed on the board.

Metal Terminals. When soldering metal terminals (e.g., switch terminals, potentiometers, etc.), ordinary 60/40 solder can be used. Use a soldering iron with a 40 to 70 watt rating and a 1/8 inch wide wedge-shaped tip.

NOTE

Observe the following precautions when soldering:

1. *Apply only enough heat to make the solder flow freely. Use a heat sink to protect heat-sensitive components.*

2. *Apply only enough solder to form a solid connection. Excess solder may impair the function of the part.*

3. *If a wire extends beyond the solder joint, clip off the excess.*

4. *Clean the flux from the solder joint with a flux-remover solvent.*

Circuit Board Replacement

If a circuit board is damaged beyond repair, either the entire assembly, including all soldered on components, or the board only, can be replaced. Part numbers are given in the Electrical Parts List (Section 8) for the completely wired (670-XXXX-XX) boards.

Sometimes the boards have to be removed to replace faulty components. The Compensation Boards must be removed from the 7S14 in order to check the components located on the boards. The Sampler Cover Board must be removed to check or replace components on the Sampler Boards. The 7S14 may be operated with the Sampler Cover Board removed by replacing the cover with test fixture 067-0693-00. In order to operate both channels it requires two of these test fixtures.

The following paragraphs will explain how to remove and replace each board in the 7S14.

A. Sampler Board Cover Removal.

1. Remove the 11 screws that secure the Sampler Board Cover to the Sampler Board honeycomb cavity.

2. Lift the cover upward carefully so the connector pins do not bend.

3. To replace the cover, reverse this procedure.

B. Vertical Board Removal.

1. Remove the Sampler Board Cover as described in part A.

2. Remove all the pin terminal connectors from the front side of the Vertical Board.

3. Remove the 4 securing screws.

4. Carefully lift the board far enough to reach the pin terminal connectors on the back of the board, then disconnect these connectors.

5. To replace the Vertical Board, reverse this procedure.

C. Sampler Board Removal (Two boards).

1. Remove the Sampler Board Cover as described in part A.

2. Remove the 2 forward-most securing screws of the Vertical Board.

3. Remove the 4 securing screws of the Sampler Board.

4. Remove the screw (at the rear of the Sampler Boards) that secures the bracket to the Sampler Board honeycomb cavity.

5. Push outward on the honeycomb cavity enough to allow the connectors from the Sampler Boards to the Delay Lines to separate.

6. Disconnect the coaxial cable from the back of the Sampler Board and remove the Sampler Board. (See Fig. 6-17B for view of the coaxial receptacle—the coaxial connector is on the cables that insert in these receptacles.)

7. To replace the Sampler Board, reverse this procedure.

D. Vertical and Horizontal Interface Board Removal.

1. Remove the rear panel (8 panel screws).

2. Remove all the pin terminal connectors from the Vertical Interface board and the Horizontal Interface board. (Pin terminal connector P-3 may be left connected

to one of the boards if desired; this is the intertie between the Vertical and Horizontal Interface boards.)

3. To remove the Vertical or the Horizontal Interface boards from the rear panel assemblage, spread the securing wings of the circuit board guide and slide the boards out.

4. To replace the Vertical or Horizontal Interface boards, reverse this procedure.

E. Delay Line Removal.

1. Remove the screw that secures the bracket to the Sampler Board honeycomb cavity.

2. Remove all the pin terminal connectors from the front side of the Vertical Board.

3. Remove the 2 forward-most securing screws of the Vertical Board.

4. Push outward on the honeycomb cavity enough to allow the connectors between the Sampler Boards and the Delay Lines to separate.

5. Disconnect the removable coaxial cables from the back of the Sampler Boards.

6. Remove the pin terminal connectors from the back of the Vertical Board and remove the Vertical Board and Sampler Board assembly.

7. Remove the angle bracket support screws. There are 3 screws on each of the 2 brackets (1 to the frame section and 2 to the Delay Lines).

8. Remove the angle brackets.

9. Disconnect the removable coaxial cables from the back of the CH 1 and CH 2 INPUT connectors of the front panel.

10. Remove the 4 Delay Line support screws.

11. Move the Delay Line assembly toward the rear and upward enough that the removable coaxial cable can be disconnected from the Delay Line Compensation Board.

12. Carefully move the Delay Line Assembly outward from the unit enough that the pin terminal connectors on the Readout board are accessible.

13. Remove the pin terminal connectors from the Readout board and remove the Delay Line, Compensation Board, and Readout board assembly.

14. To replace the Delay Lines, reverse this procedure.

NOTE

A later step describes a method for removing the Readout Board, but, if preferred, the Readout Board can be removed by removing the Delay Line assembly as described here, then removing the 4 Readout Board support screws.

F. Compensation Board Removal.

1. Remove the Delay Lines as described in part E.

NOTE

If only the Channel 2 Compensation Board is to be removed, steps 2 through 6 can be omitted.

2. Remove the 4 screws from the Channel 1 Compensation Board cover and remove the cover.

3. Unsolder the Delay Line from the Channel 1 Compensation Board.

4. Remove the 4 Compensation Board securing screws.

5. Remove the Channel 1 Compensation Board.

6. To replace the Channel 1 Compensation Board, reverse this procedure.

NOTE

If only the Channel 1 Compensation Board is to be removed, steps 7 through 12 can be omitted.

7. Remove the 4 bracket screws from the Channel 1 Compensation Board bracket and move the bracket out of the way (if the Channel 1 Delay Line has been removed, remove the assembly).

Maintenance—7S14

8. Remove the 4 screws from the Channel 2 Compensation Board cover and remove the cover.

9. Unsolder the Delay Line from the Channel 2 Compensation Board.

10. Remove the 4 Compensation Board securing screws.

11. Remove the Channel 2 Compensation Board.

12. To replace the Channel 2 Compensation Board, reverse this procedure.

G. Trigger Board Removal.

1. Remove the Trigger Board securing screw.

2. Lift the Trigger Board perpendicularly outward to avoid bending the interconnecting pins.

3. To replace the Trigger Board, reverse this procedure.

H. Horizontal Board Removal.

1. Disconnect all the pin terminal connectors from the front side of the Horizontal Board. (It may be easier to remove the P1 and P15 connectors if the Trigger Board is first removed, as described in part G.)

2. Remove all the screws from the rear bracket (8 screws) and remove the bracket.

3. Remove the DELAYED SWP VAR, DELAYED SWEEP, and DELAYING SWEEP controls from the front panel.

4. Remove the 4 Horizontal Board securing screws.

5. Disconnect the pin terminal connectors located on the back side of the board.

6. Disconnect the two removable coaxial cables on the back side of the board that are located just in front of P16.

7. Pull the Horizontal Board back carefully (there are still cables connected to the board) far enough for the front panel controls to clear the front panel.

8. Disconnect the removable coaxial cable from the back of the EXT INPUT connector.

9. Carefully maneuver the Horizontal Board so that the upper edge is out beyond the edge of the frame. (The frame has to be spread slightly to accomplish this maneuver.)

10. Disconnect the removable coaxial cable that is attached to the connector located nearest the forward edge on the back side of the board.

11. Remove the remainder of the pin terminal connectors from the back of the Horizontal board then remove the Horizontal Board.

12. To replace the Horizontal Board, reverse this procedure. Use a pair of long-nosed pliers to reconnect the cables on the back side of the board.

I. Readout Board Removal.

1. Remove the Horizontal Board as described in part H.

2. Remove the pin terminal connectors from the Readout Board.

3. Remove the 4 Readout Board securing screws and remove the board.

4. To replace the Readout Board, reverse this procedure.

J. Vertical Mode Switch Board Removal.

1. Remove the Delay Line assembly as described in part E.

2. Disconnect all the pin terminal connectors from the Vertical Mode Switch Board.

3. Remove the 2 Mode Switch bracket support screws (1 screw in the top left frame section and 1 screw in the bottom left frame section).

4. Remove the bracket and the Vertical Mode Switch Board by pulling back far enough to clear all the front panel components, then twist CW and pull out.

5. If the Vertical Mode Switch Board is to be changed, remove the board from the bracket by removing the 2 board support screws.

6. To replace the Vertical Mode Switch Board, reverse this procedure. Use a pair of long-nosed pliers to reconnect the cables to the board.

Component Replacement

WARNING

Remove any connections to the front panel of the 7S14 and disconnect the 7S14 from the mainframe before replacing components.

Most components on the Vertical Board, Horizontal Board, or the Trigger Board can be replaced without removing the boards from the instrument. The following paragraphs describe how to replace the individual components.

Semiconductor Replacement. Semiconductors should not be replaced unless they are actually defective, because replacement of semiconductors may affect the calibration of the instrument. If any semiconductors are removed from their sockets during routine maintenance, return them to their original sockets. When semiconductors are replaced, check the operation of the part of the instrument which may be affected.

Replacement semiconductors should be of the original type or a direct replacement. Fig. 6-1 shows the lead configuration of the semiconductors used in the 7S14. Some transistor cases have lead configurations that do not agree with those shown in Fig. 6-1. If a replacement transistor is made by a different manufacturer than the original, check the manufacturer's basing diagram for correct basing.

When replacing components that are matched, both components must be replaced even if only one of the components is defective. These matched components must be purchased from Tektronix, Inc.

NOTE

Q10 of the Channel 1 Sampler and Channel 2 Sampler are a matched pair. The replacement of one requires the replacement of the other.

An extracting tool should be used to remove the rectangular cased integrated circuits to prevent damage to the pins. This tool is available from Tektronix, Inc. Order Tektronix Part Number 003-0619-00.

Connector Replacement. Several types of connectors are used in the 7S14 for interconnecting the boards or the components. Two types of connectors are used on the front panel. One type is a panel mounting BNC connector with cable attachment. The second type is a jack tip connector that is encased in an insulating bushing.

There are three types of connectors used on the circuit boards. The first type is a terminal pin which is soldered into the circuit board. There are two types of mating connectors used with the terminal pins. If the mating connector is mounted on a plug-on circuit board, a special pin terminal socket is soldered into the board. If the mating connector is on the end of a lead, a lead-end pin terminal connector is used. A second type of connector used on the circuit boards is a 3-prong circuit-board-mounting coaxial connector. The mating connector used with this type of connector and with the BNC panel connector is a removable coaxial connector attached to coaxial cables. The third type of connector is a miniature coaxial connector that is used to connect the Sampler Boards to the Delay Lines. The following information provides the replacement procedure for the various connectors.

A. BNC CONNECTOR.

To replace a BNC connector, first unplug the removable coaxial connected cable. Remove the cable that is soldered on the back of the connector. Remove the nut from the rear of the connector and pull the connector out through the front panel. Reverse this procedure to put in the new connector.

NOTE

To replace the EXT INPUT connector, it is necessary to first remove the Horizontal Board as described in step H under Circuit Board Replacement in this section of the manual.

B. JACK TIP CONNECTOR.

To replace a jack tip connector, first remove the soldered on cable. Next, push the pin and insulator out of the jack tip holder from the back side. Push the new insulated encased jack tip into the jack tip holder from the front of the instrument. Solder the cable that was removed from the old jack tip to the solder terminal of the new jack tip.

C. CIRCUIT BOARD TERMINAL PINS.

NOTE

A circuit-board pin replacement kit including necessary tools, instructions, and replacement pins is available from Tektronix, Inc. Order Tektronix Part Number 040-0542-00.

To replace a pin that is mounted on a circuit board, first disconnect any pin connectors. Next, unsolder the damaged pin and pull it out of the circuit board with a pair of pliers. Be careful not to damage the board by applying too much heat. Ream out the hole in the circuit board with a 0.031 inch drill. Remove the ferrule from the new interconnecting pin and press the new pin into the hole in the circuit board. Position the pin in the same manner as the old pin. Then, solder the pin on both sides of the circuit board.

D. CIRCUIT BOARD PIN SOCKETS.

The pin sockets on the circuit boards are soldered to the board. To replace one of these sockets, first unsolder the pin (use a vacuum-type desoldering tool to remove excess solder). Next, straighten the tabs on the socket and remove it from the hole in the circuit board. Place the new socket in the circuit board hole and press the tabs down against the board. Solder the tabs of the socket to the circuit board; be careful not to get solder into the socket.

E. LEAD-END PIN CONNECTOR.

The pin connectors used to connect the wires to the circuit board terminal pins are clamped to the ends of the associated wires. To replace damaged lead-end pin connectors, remove the old pin connector from the end of the wire lead and clamp the replacement connector to the lead.

Some of the pin connectors are grouped together and mounted in a plastic holder; the overall result is that these connectors are removed and installed as a multi-pin connector. To provide correct orientation of a multi-pin connector, when it is connected to the associated terminal pins, an arrow is stamped on the circuit board and a matching arrow is molded into the plastic housing of the multi-pin connector. Be sure that these arrows are aligned when the multi-pin connector is connected to the terminal pins. If the lead-end connectors are removed from the plastic holder, note the colors of the individual wires for orientation when placed back in the holder.

F. CIRCUIT-BOARD-MOUNTING COAXIAL CONNECTOR.

The 3-prong circuit-board-mounting coaxial connector is used on circuit boards as a receptacle for removable coaxial

cables. To remove a 3-prong coaxial connector from the circuit board, first remove the solder from the circuit board holes holding the 3 prongs (use a vacuum-type desoldering tool to remove excess solder), then remove the socket. Next, if necessary, unsolder the wire-end terminal and remove it from the board. Place a new wire-end terminal in the board and solder in place. Then place a new 3-prong coaxial connector in place on the board and solder the terminals to the board.

G. REMOVABLE COAXIAL CONNECTOR.

Removable coaxial connectors are used on the coaxial interconnecting cables to interface with the 3-prong coaxial connectors on the circuit boards or the BNC connectors on the front panel. Because the length of cables is important and since it is difficult to connect these connectors to the cables, it is recommended that the assembled cable be ordered if replacement is necessary.

H. MINIATURE COAXIAL CONNECTOR.

There are 2 miniature coaxial connectors used in the 7S14. They are used to connect the Sampler Boards to the Delay Lines. The plug portion of this connector is attached to the Delay Line and the receptacle end of the connector is attached to the Sampler Board. To replace the plug portion of this connector, the Delay Line Assembly must be removed. After the Delay Line assembly has been removed, remove the bracket at the back of the Delay Line assembly. Next, remove the nut that secures the plug portion of the connector to the frame. Now, remove the connector from the Delay Line by unscrewing the plug from the cable connector. Reverse this procedure to replace the plug end of the connector.

To remove the receptacle portion of the connector from the Sampler Board requires the removal of the electrical shield and the electrical components CR1, R16, R18, R34, and R35 from the Sampler Board after the Sampler Board has been removed from the instrument. After these components have been removed, the three support posts of the connector must be unsoldered, then the connector can be removed.

To put a new connector on the Sampler Board, first remove one of the four legs from the connector. Then place the connector through the three holes in the Sampler Board and solder in place. Next attach the detached electrical components to their proper points. Then solder the shield back in place.

Push-button Switches. The push-button switches are not repairable and should be replaced if defective. Some of the push-button switches are installed as a unit and the entire switch unit should be replaced if a switch is defective.

Rotary Switches. Individual parts or sections of rotary switches are not usually repaired. If a rotary switch is defective, the entire assembly should be replaced. These switches can be ordered with or without the associated components wired in place. Part numbers are given in the Electrical Parts List.

When removing a switch, mark the leads and the switch contacts with corresponding identification tags. This way, the old switch may be used as a model for installing the new switch. When soldering the leads to the new switch, do not let the solder flow beyond the rivet on the switch terminal. Spring tension of the switch contact can be destroyed by excessive solder.

Cam Switch. The cam switch consists of rotating cams, which are turned by front panel controls, and a set of contacts mounted on the adjacent Horizontal Board. These switch contacts are actuated by lobes on the cam. The Delaying Sweep/Delayed Sweep cam switch can be disassembled for inspection, cleaning, repair, or replacement as follows:

NOTE

A cam switch repair kit including necessary tools, instructions, and replacement contacts is available from Tektronix, Inc. Order Tektronix Part Number 040-0541-00.

1. Remove the Horizontal Board as described in step H under Circuit Board Replacement in this section.

2. Remove the 3 screws which hold the metal cover over the switches then remove the cover. The switches are now open for inspection or cleaning. The front section of the unit is the DELAYING SWEEP switch and the rear section is the DELAYED SWEEP switch.

3. To completely remove the cam switches from the board, remove the six securing screws from the front of the Horizontal Board, disconnect pin connectors P7 and P9 and lift the switch assembly from the board.

4. The 2 sections of the switch (front section being DELAYING SWEEP and DELAYED SWEEP VAR) can be separated by pulling the DELAYING SWEEP forward over the DELAYED SWEEP shaft.

5. To remove the DELAYING SWEEP cam, loosen the back hexagonal screw of the shaft sleeve, remove the shaft and sleeve, remove the retaining ring from the cam shaft, then remove the cam.

6. To remove the DELAYED SWEEP cam, unscrew the hexagonal post from the rear of the DELAYED SWEEP cam, remove the DELAYED SWEEP VAR resistor, remove the retaining ring from the cam shaft, then remove the cam.

7. To replace defective switch contacts on the Horizontal Board, follow the instructions given in the switch repair kit.

8. To reinstall the switch assembly, reverse the above procedure.

Recalibration After Repair

After any electrical component has been replaced, the calibration of that particular circuit should be checked. Any closely related circuits should also be checked for proper calibration. Since the voltage supplies affect all circuits, calibration of the entire instrument should be checked if work has been done on the voltage supplies.

Instrument Repackaging

If the Tektronix instrument is to be shipped to a Tektronix Service Center for service or repair, attach a tag showing: owner (with address) and the name of an individual at your firm that can be contacted, complete instrument serial number and a description of the service required.

Save and re-use the package in which your instrument was shipped. If the original packaging is unfit for use or not available, repackage the instrument as follows:

Surround the instrument with polyethylene sheeting to protect the finish of the instrument. Obtain a carton of corrugated cardboard of the correct carton strength and having inside dimensions of no less than six inches more than the instrument dimensions. Cushion the instrument by tightly packing three inches of dunnage or urethane foam between carton and instrument, on all sides. Seal carton with shipping tape or industrial stapler.

The carton test strength for your instrument is 275 pounds.

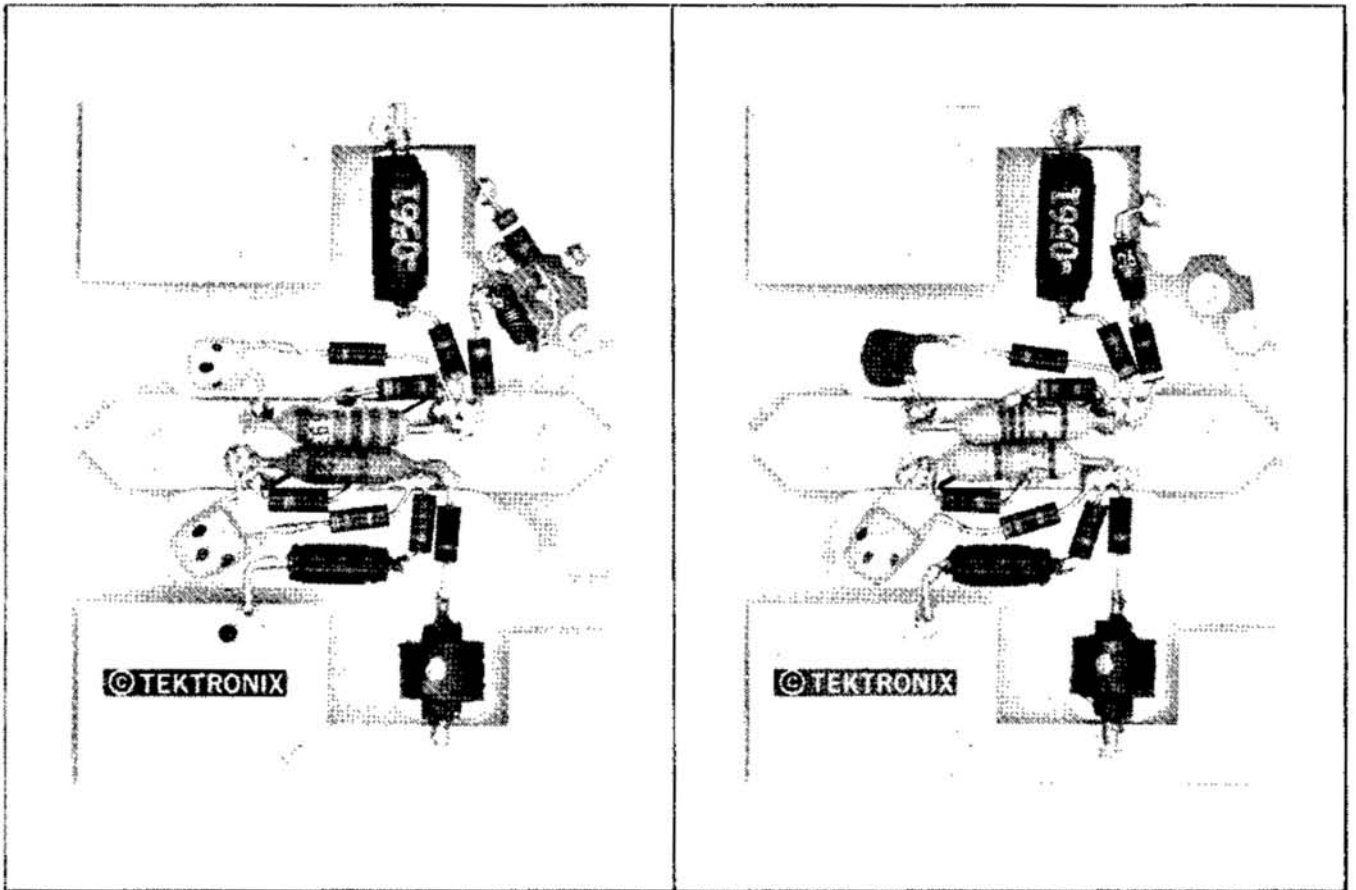

Fig. 6-12. (A) CH 1 Compensation Board. (B) CH 2 Compensation Board.

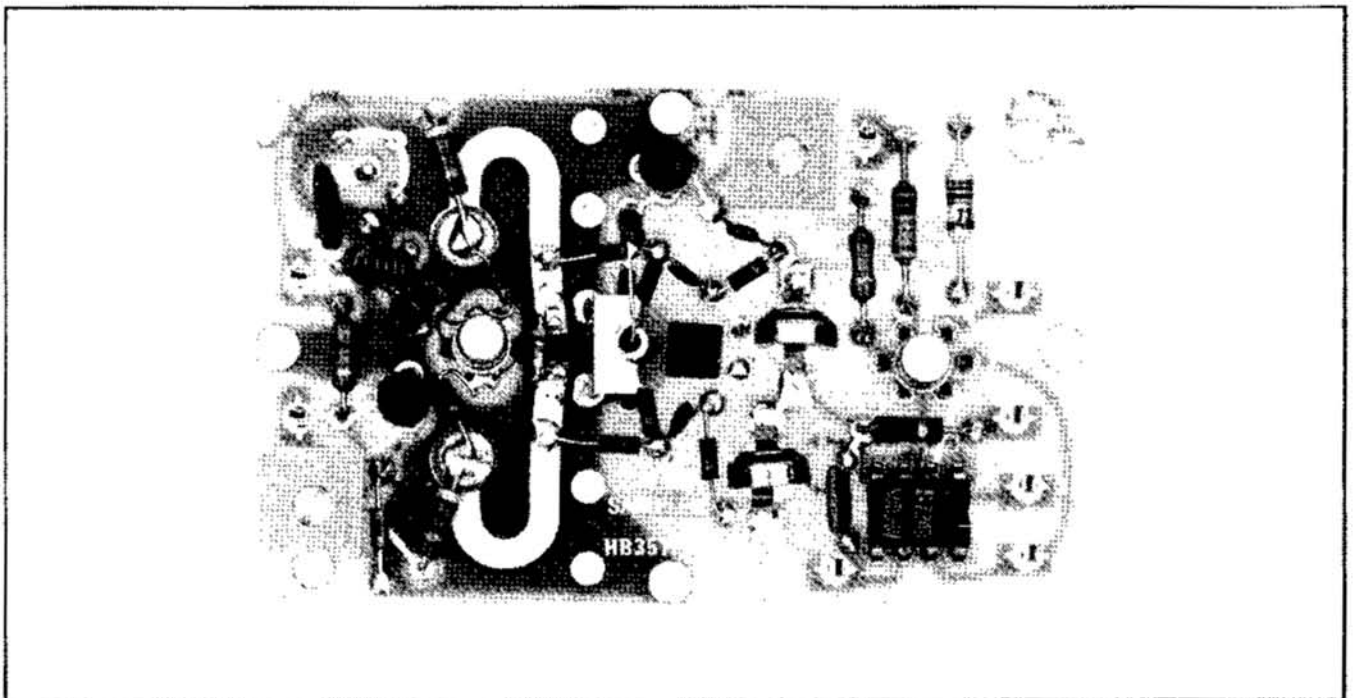

Fig. 6-13. Sampler Board (one for each channel).

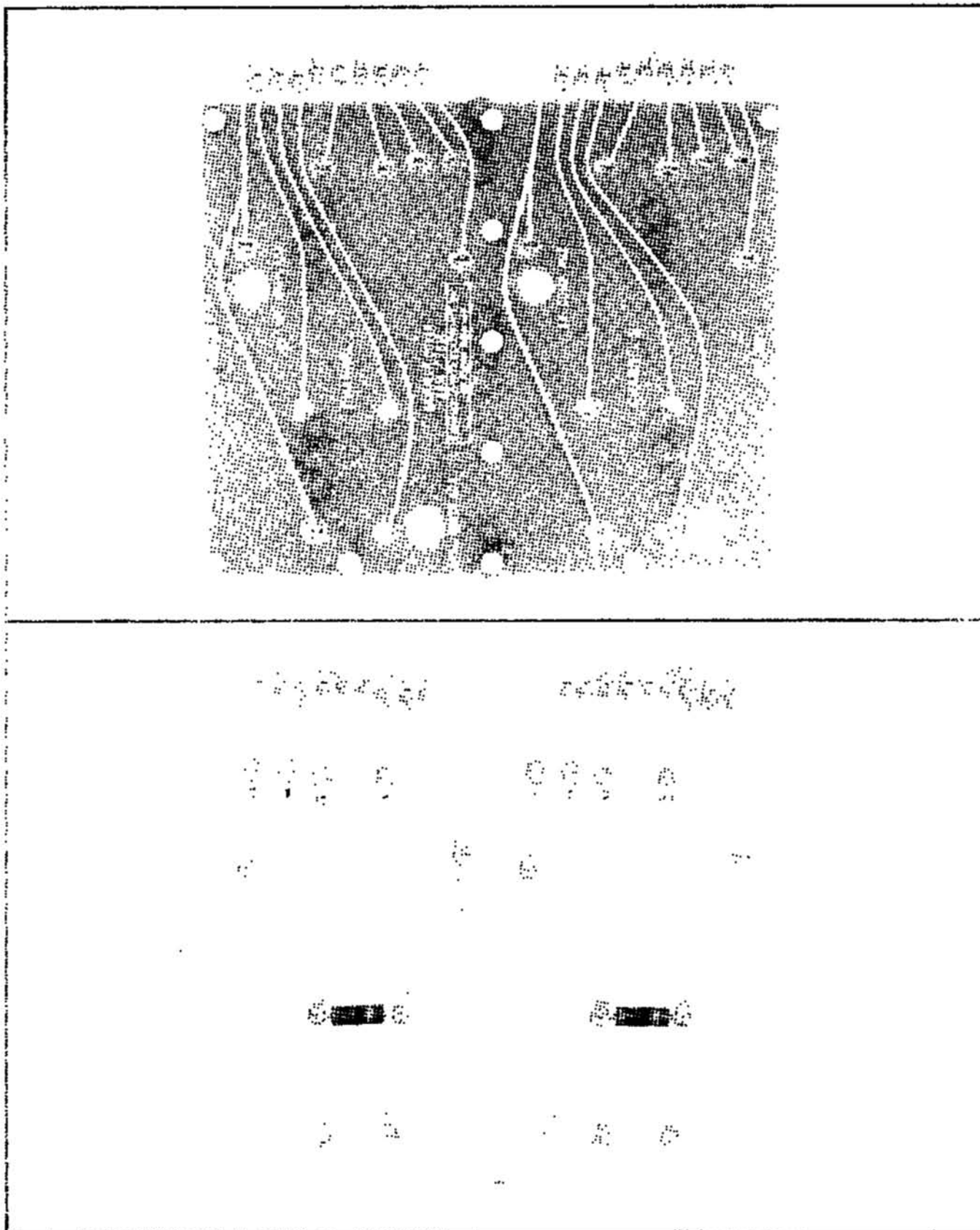

Fig. 6 14. (A) Sampler Board Cover (Front View). (H) Sampler Board Cover (Rear View).

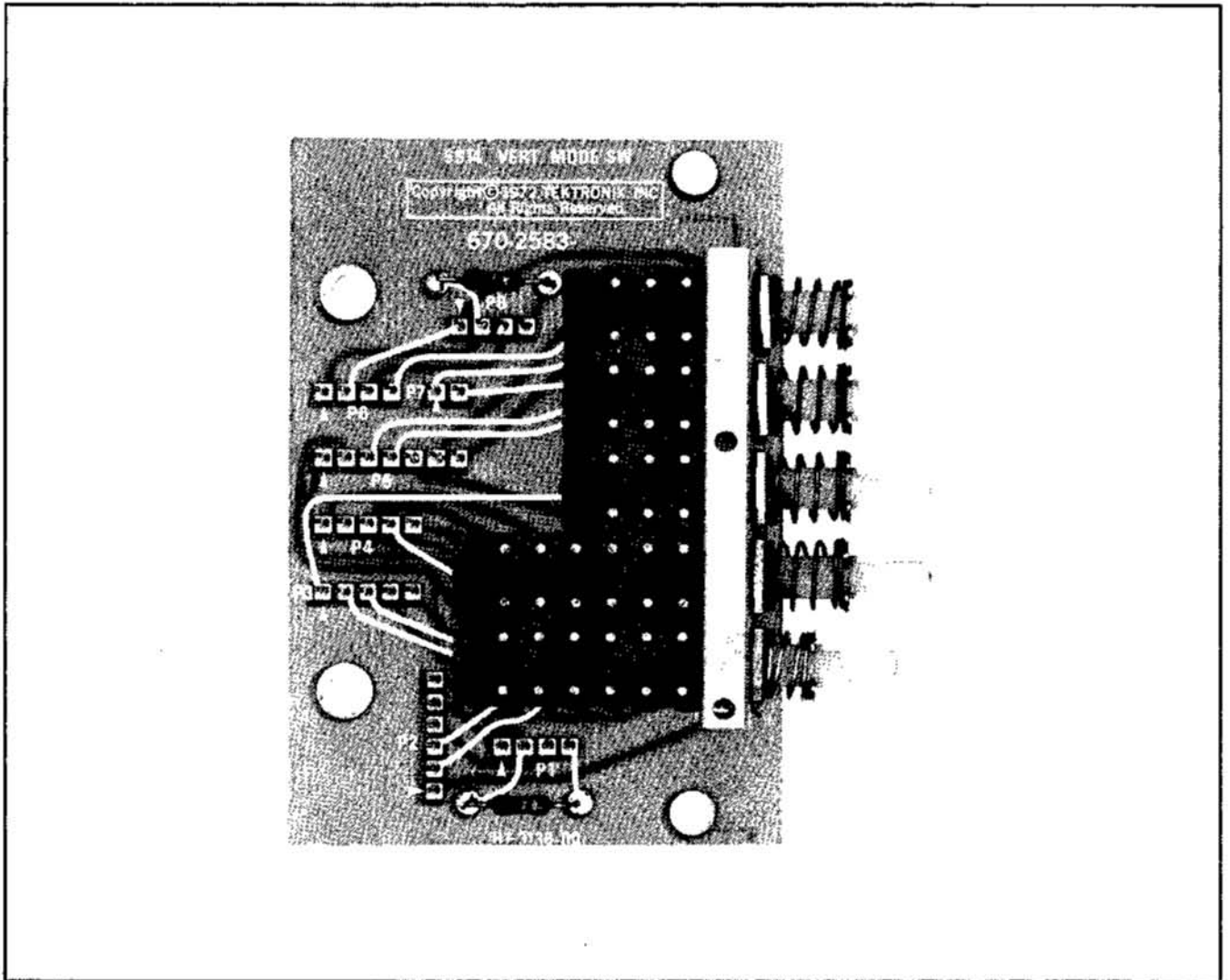

Fig. 6-15. Vertical Mode Switch Board.

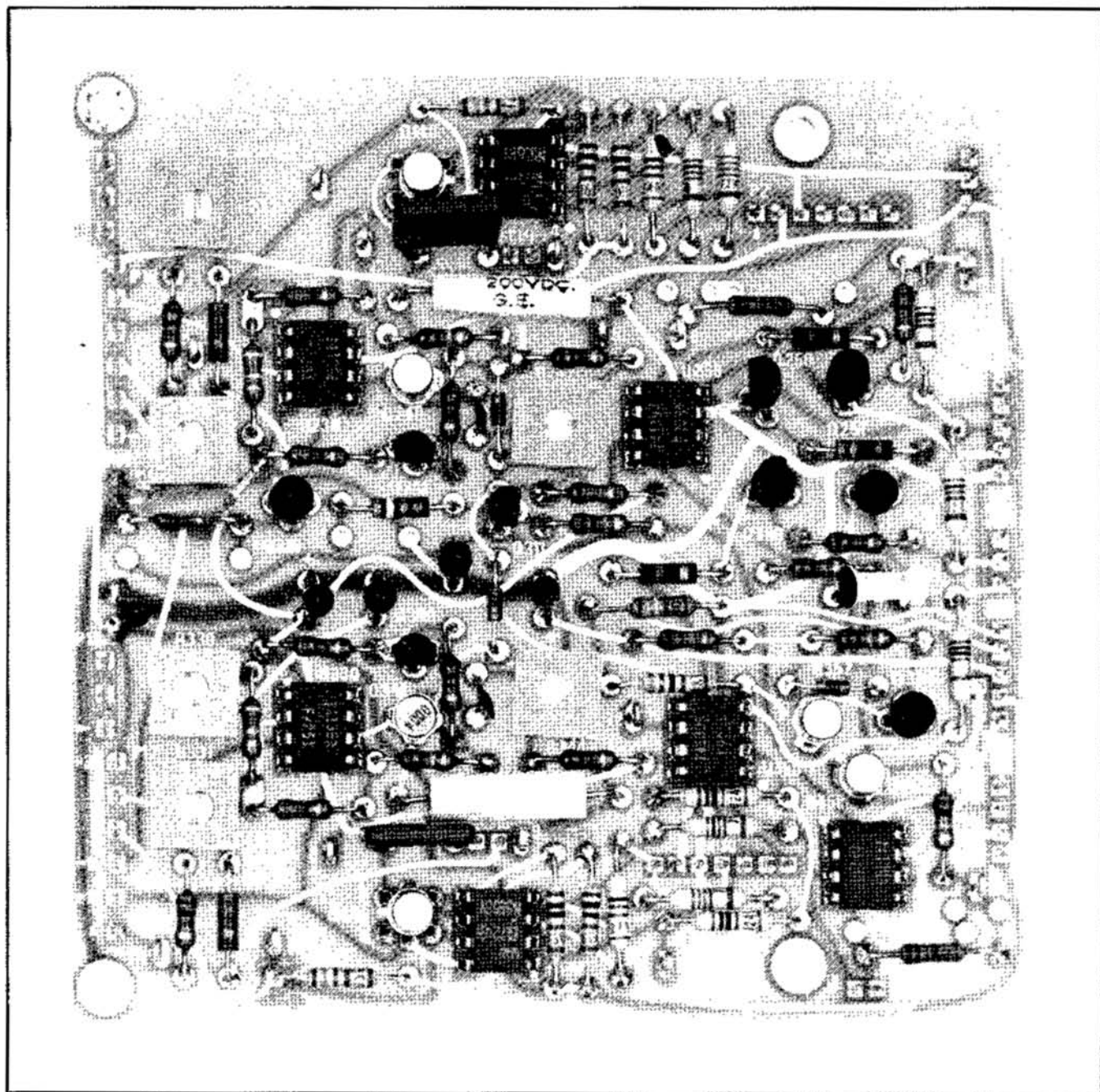

Fig. 6-16. Vertical Board.

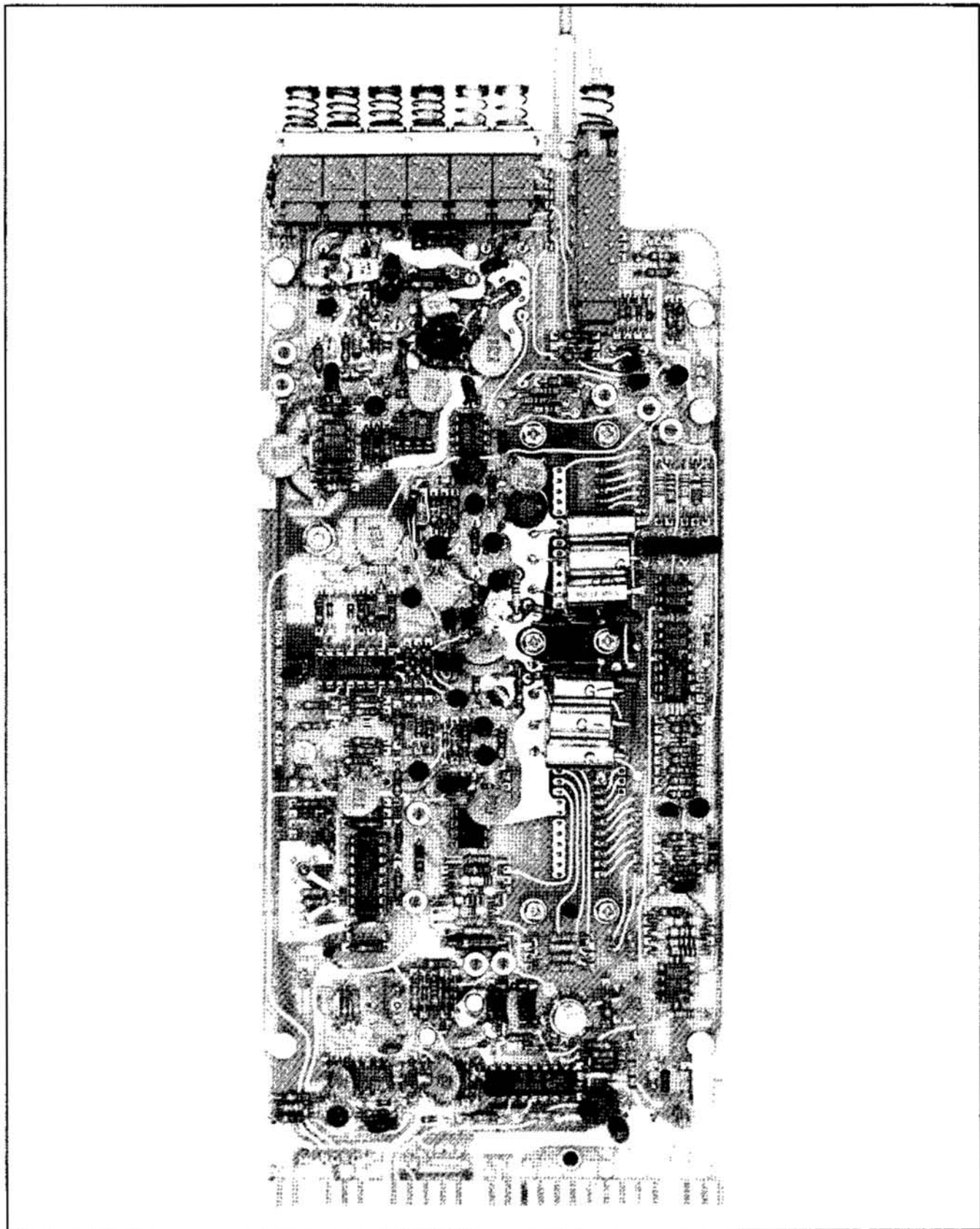

Fig. 6-17A. Horizontal Board (Front View).

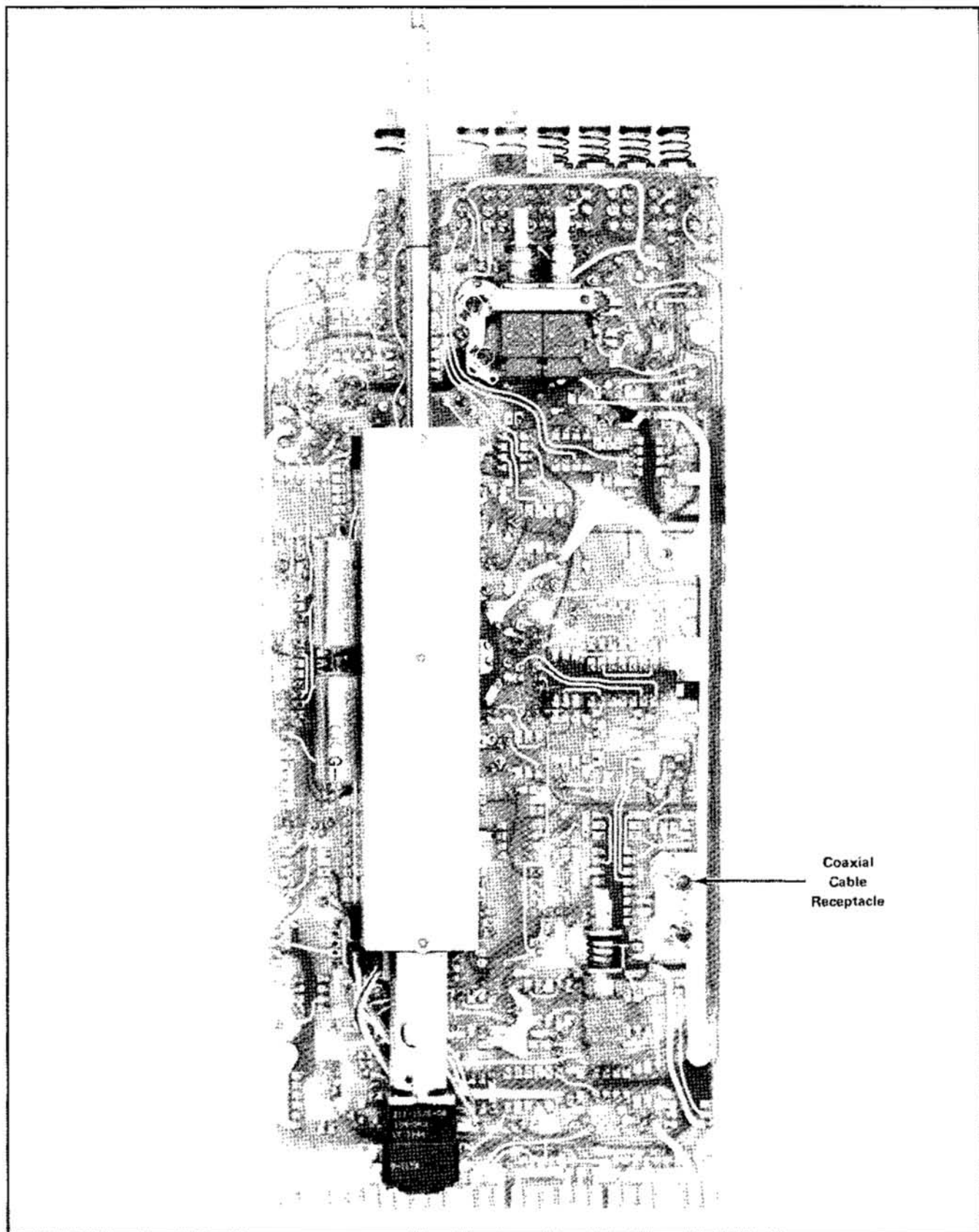

Fig. 6-17B. Horizontal Board (Rear View).

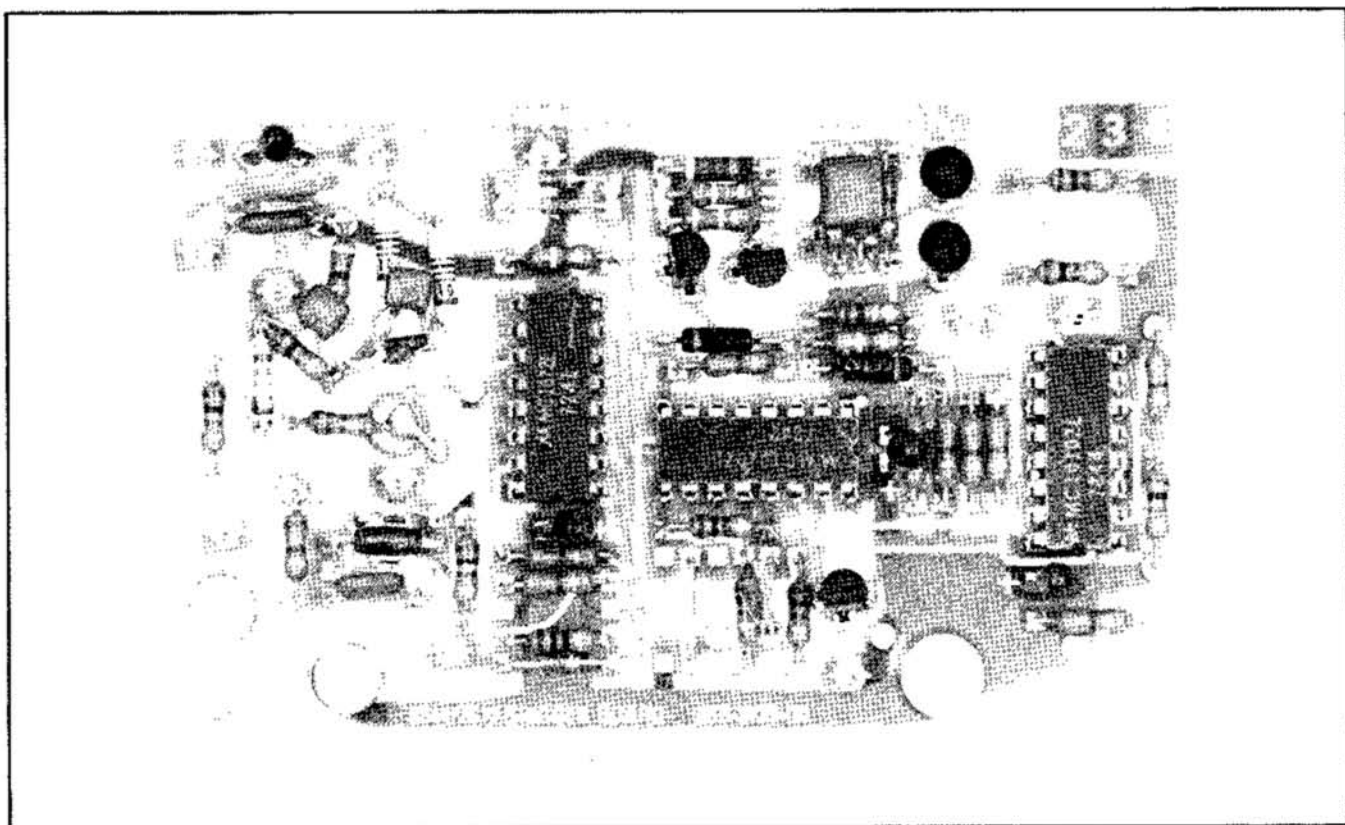

Fig. 6-18. Trigger Board.

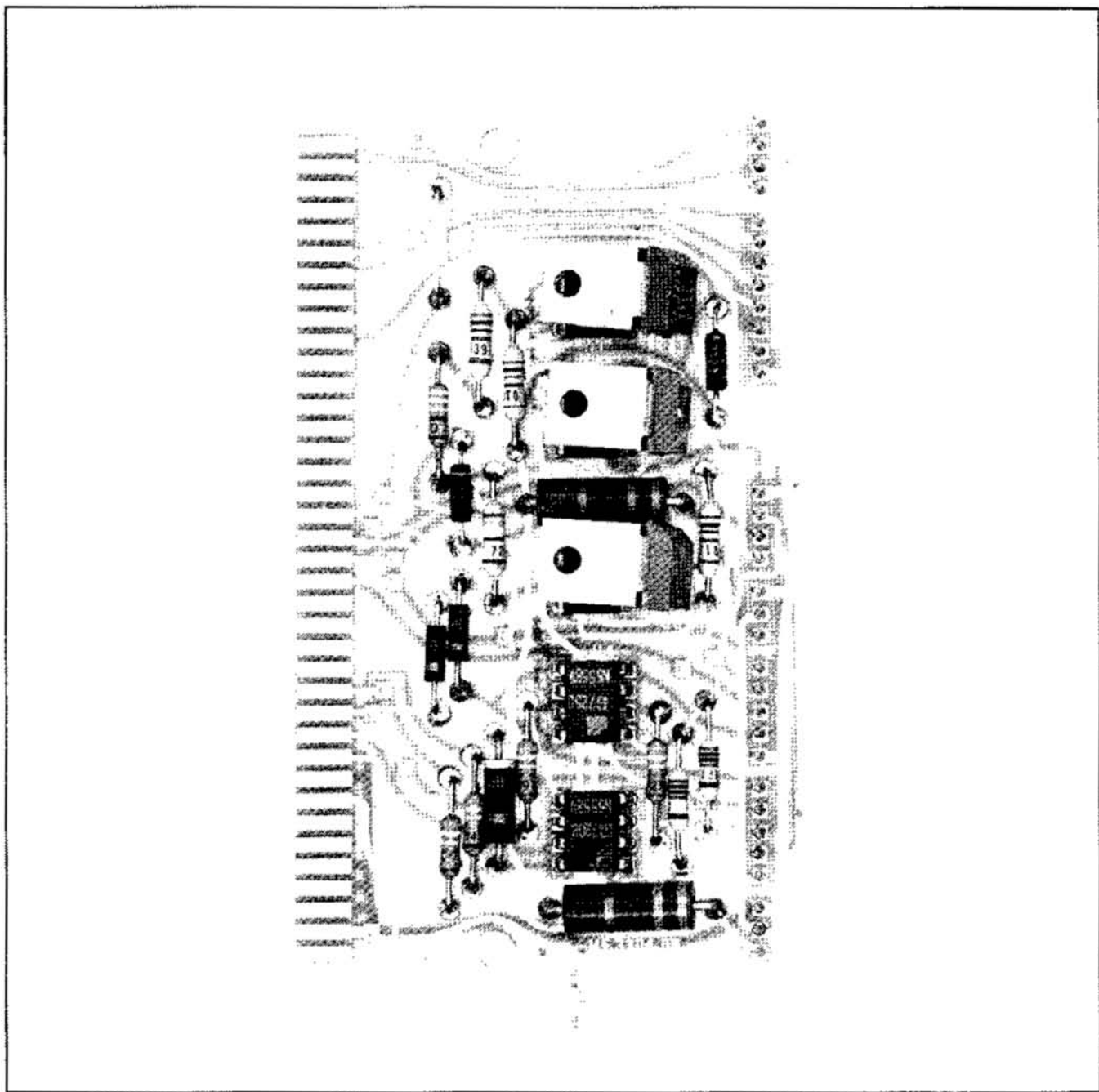

Fig. 6-19. Vertical Interface Board.

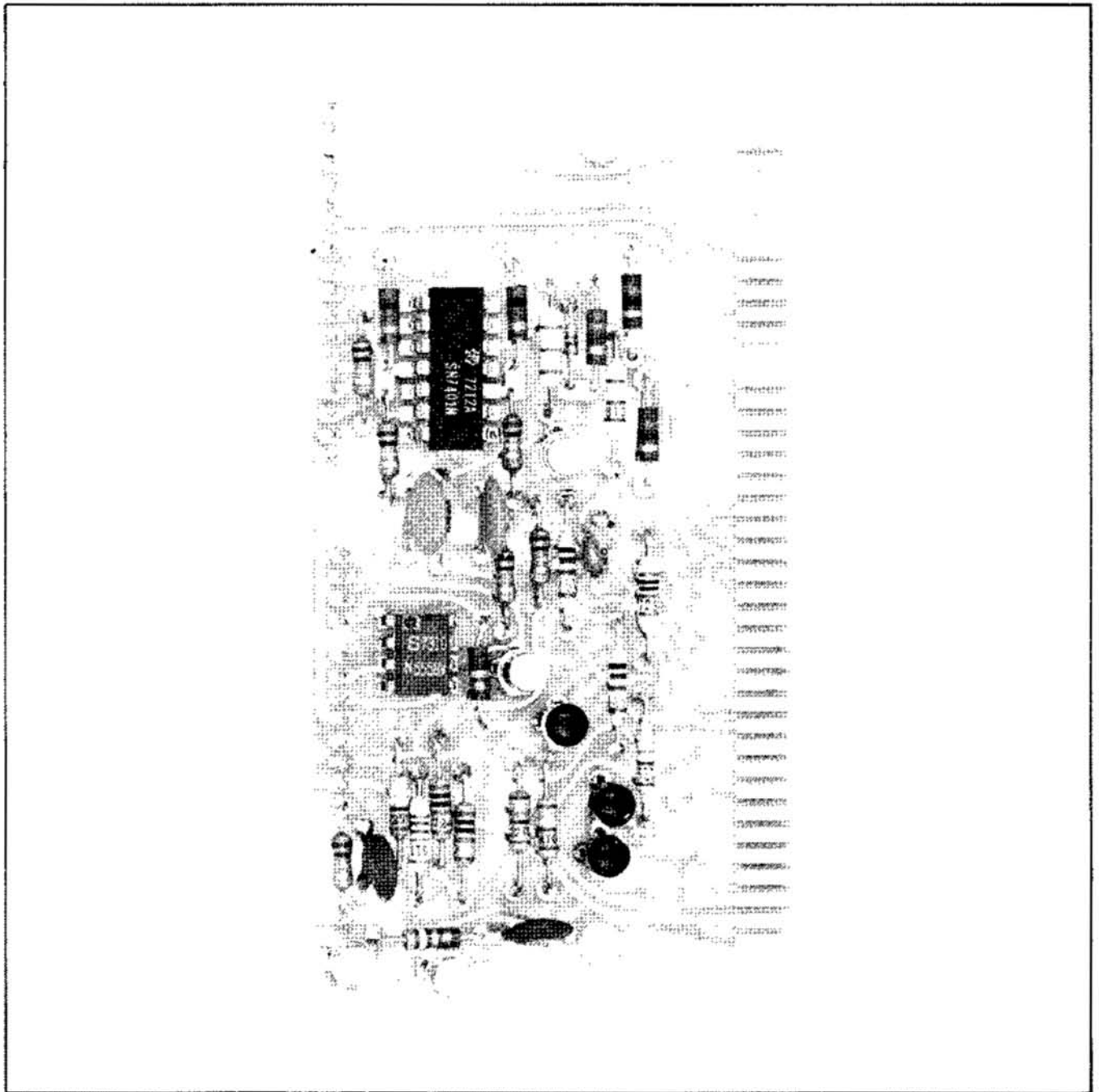

Fig. 6-20. Horizontal Interface Board.

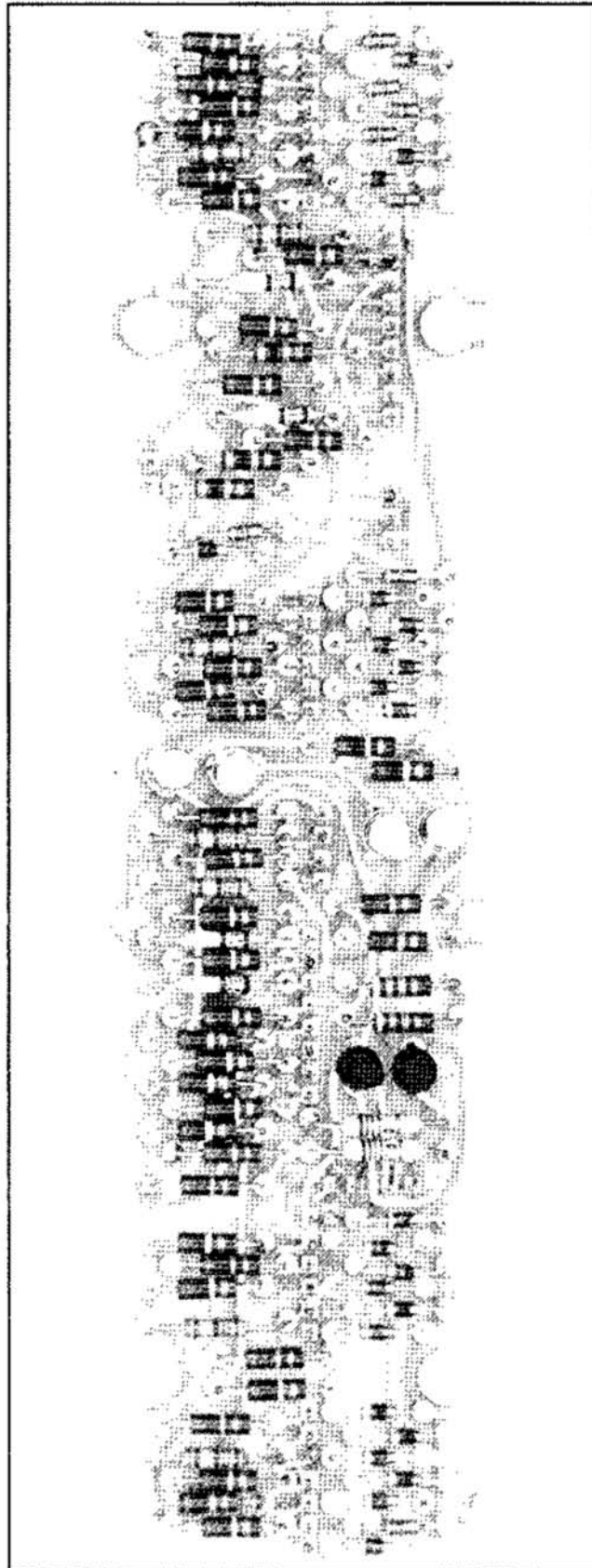

Fig. 6-21. Readout Board.

PERFORMANCE CHECK/CALIBRATION

ELEMENTARY CHECKS AND INCOMING INSPECTION

The performance checks in this section may be made without any test equipment and with very little special skill. Even so, nearly all electrical failures in the equipment may be detected using this section. It is recommended that these checks be performed before those in the DETAILED CHECKS AND ADJUSTMENTS section, because these elementary checks will identify most conditions calling for troubleshooting and repair. To aid in troubleshooting, the probable problem area(s) will be given after each applicable step.

1. Insert the 7S14 into the correct slots of an appropriate oscilloscope mainframe and turn the power on. The two slots to the operators right should be used in mainframes that accommodate three single-width plug-ins or the two middle slots should be used in mainframes that accommodate four single-width plug-ins.
2. Disconnect any input signals from the 7S14 front panel.
3. Release all pushbuttons except the following: CH 1, INT CH 1, HF SYNC, SWP, AUTO TRIG, +SLOPE, and REP. Push the mainframes Vertical Mode RIGHT button and Horizontal Mode A button.
4. Set both the CH 1 and CH 2 VOLTS/DIV controls to .5 V and check that the red CAL controls are set counterclockwise into the detented positions.
5. Center the DC OFFSET controls by setting the white dots straight up, at the 12 o'clock position.
6. Set the SCAN control fully clockwise and the TRIGGERING HOLDOFF control (center control) fully counterclockwise.
7. Set the DELAYING SWEEP (dark gray) control and the DELAYED SWEEP (light gray) control to 1 μ s per division.
8. Set the oscilloscope mainframe beam INTENSITY control for a medium bright trace. (If unable to obtain a trace, the problem could be in the oscilloscope mainframe or power supplies or with one of the following 7S14 circuits: CH 1 Vertical, Channel Switching Multi, Strobe Generator, Memory Gating Generator, Delaying Ramp Gen, Scan Ramp Gen, or CRT Blanking circuits.)
9. Set the CH 1 VOLTS/DIV switch to 20 mV and center the trace with the DC OFFSET control. Set the VOLTS/DIV back to .5 V and note the vertical position of the trace. This position is the electrical center for the oscilloscope. Check that the Channel 1 DC OFFSET control positions the trace at least 4 major divisions from the electrical center in one direction and off screen in the other direction. (If the trace can not be positioned over the correct range, the trouble is probably in the CH 1 Post Memory Amplifier or the CH 1 Output Amplifier.)
10. Push the CH 2 button, releasing the CH 1 button, and repeat the previous step, using the Channel 2 controls. (If unable to get a trace, the trouble is probably in the CH 2 Strobe Generator or one of the CH 2 vertical deflection stages. If the trace is not positionable, the problem is probably in the CH 2 Post Memory Amplifier or the CH 2 Output Amplifier.)
11. Push both the CH 1 and CH 2 buttons for dual trace operation; check that two traces are displayed and that they may be positioned independently with the DC OFFSET controls. (If unable to obtain a dual trace display, the trouble is probably in the Channel Switching Multi circuit.)
12. Push the ADD button; check that only one trace remains and that either DC OFFSET control affects the trace position. (If one OFFSET control does not move the trace, the trouble is probably with the ADD switch.)
13. Push the CH 1 Y CH 2 X button; check that a single dot appears on screen, that the dot may be positioned vertically over most of the screen with the Channel 1 DC OFFSET control, and can be positioned horizontally over most of the screen with the Channel 2 DC OFFSET control. (If there is no horizontal positioning, the trouble is probably with the CH 1 Y CH 2 X switch.)

Calibration Procedure—7S14

14. Push the CH 2 INVERT button; check that the dot may be positioned horizontally over about the same range as in the previous step and that clockwise rotation of the Channel 2 DC OFFSET control moves the dot from right to left. (If there is no movement, the trouble is probably with the CH 2 Unity Gain Inverter.)

15. Release the CH 2 INVERT button and push the CH 1 button. Push the LO NOISE button and check that the horizontal scan rate reduces to about one or two scans per second. (If there is no change in the scan rate, the trouble is probably with the LO NOISE switch.)

16. Release the LO NOISE button and rotate the SCAN control counterclockwise. Check that the horizontal scan rate reduces to produce an easily perceptible flicker. (If the change in scan rate is not perceptible, the trouble is probably in the Scan Inverter or because the Scan Rate potentiometer, R381, is improperly adjusted.)

17. Set the SCAN control fully clockwise. Rotate the HOLDOFF control clockwise and check that the scan rate reduces to produce about the same flicker as in the preceding step. (If there is no perceptible change in the scan rate, the trouble is probably in the Holdoff Ramp Generator.)

18. Set the HOLDOFF control fully counterclockwise. Release the HF SYNC button and check that a scan is still produced about every 3 to 10 seconds. (If there is no scan or an extremely slow scan, the trouble is probably with the Auto Baseline Trigger.)

19. Near the end of one scan, release the AUTO TRIG button. Check that the scan rate reduces considerably and that a new scan does not start again after the beam has gone off screen or is blanked. (If the trace does not slow down and repeat, there is probably noise or an extraneous triggering signal being delivered from the trigger amplifier.)

20. Push the AUTO TRIG button, the HF SYNC button and the SINGL SCAN button. Check that no trace appears. Push the spring-loaded START button and check that one and only one scan is produced each time the START button is released. (If no trace is produced or more than one is produced, the trouble is probably in the Scan Ramp Gating Multi or the Start switch.)

21. Push the MAN (manual scan) button and check that a dot may be positioned over most, if not all, of the screen using the SCAN control. Set the SCAN control fully counterclockwise and check that the dot is still on screen.

If not, the front panel HORIZ POS screwdriver adjustment should be used to position the dot near the left edge of the graticule. (If there is no dot or if it can not be positioned, the trouble is probably with the MAN switch or the associated circuits.)

22. Push the EXT button and check that the dot is located at approximately the same position as in the previous step. (If the dot is not near the same location, the trouble is probably with the SCAN potentiometer or associated circuits.)

23. Push the REP button and set the SCAN control fully clockwise. Set the ten-turn DELAY TIME MULT dial to 2.00. Reduce the crt intensity to where the trace is barely visible and check that two bright dots appear as part of the trace. (If one or no dots appear, the trouble is probably in the 2nd Dot Pulse and Delay Gen circuit.)

24. Rotate the DELAY ZERO control; check that the two bright dots may be moved so the right-hand dot appears near the right end of the trace with clockwise rotation and the left-hand dot may be positioned near the left end of the trace with counterclockwise rotation. If the dots go off screen, the trace may be positioned with the HORIZ POS screwdriver control. (If the dots can not be positioned over most of the screen, R130 or R131 may not be properly adjusted.)

25. Release the SWP mode button and check that the trace remains but the bright dots disappear. (If the dots do not disappear the SWP switch is probably defective. If there is no sweep, the trouble is probably in the Delayed Sweep Gen or the Comparator.)

26. Push the SWP mode button in and rotate the DELAYING SWEEP control counterclockwise one step at a time, checking that a trace is produced in each step and that the bright dots remain in the same position regardless of the time per division selected. The scan rate should reduce at $2 \mu\text{s}/\text{DIV}$ and reduce further at $20 \mu\text{s}/\text{DIV}$. (If the scan rate does not change at $2 \mu\text{s}/\text{DIV}$, the problem is probably with the SEC/DIV switch.)

NOTE

The trace intensity may have to be reduced to see the bright dots at $20 \mu\text{s}/\text{DIV}$ and slower.

27. Leave the DELAYING SWEEP control in the fully counterclockwise position ($100 \mu\text{s}/\text{DIV}$). Release the SWP mode button and rotate the DELAYED SWEEP control fully clockwise; then, rotate it counterclockwise one step at

a time, checking that the scan is not interrupted at any step. It is normal that the scan rate should not change from one step to the next under these conditions. (If the scan stops or changes rate at any setting, the trouble is probably with the SEC/DIV switch).

28. If the mainframe has CRT READOUT, check that the time per division indicated on the crt screen agrees with that for each setting of the DELAYED SWEEP (light gray) control.

NOTE

500 ns, 200 ns and 100 ns on the crt correspond to .5 μ s, .2 μ s and .1 μ s on the SEC/DIV switch; and 500 ps, 200 ps and 100 ps on the crt correspond to .5 ns, .2 ns and .1 ns on the SEC/DIV switch.

Rotate the DELAYED SWP VAR (CAL) control clockwise so it is out of its detented position and check that the less-than symbol (<) appears ahead of the number. Rotate the control back to its detented position.

29. Push the SWP button and check that the time per division indicated on the crt screen agrees with that for each setting of the DELAYING SWEEP (dark gray) control.

NOTE

You should not attempt to move the DELAYING SWEEP control clockwise past the 10 ns position of the switch.

Rotate the VOLTS/DIV CAL control clockwise until it is out of its detented position and check that the less-than symbol (<) appears ahead of the number. Rotate the control back to its detented position.

31. Push the CH 2 button and repeat the previous step for the CH 2 VOLTS/DIV switch.

DETAILED CHECKS AND ADJUSTMENTS

This section gives the detailed procedure recommended for verifying that a 7S14 performs essentially as intended and according to Tektronix claims. Included are instructions for making each internal electrical adjustment. Adjustment instructions should be ignored when the procedure is being used only to determine whether there is a need for repair or adjustment.

Equipment Required

1. Tektronix 7000 Series oscilloscope mainframe, such as the 7704A.
2. Tektronix 7A13 Plug-in unit, or a DC Voltmeter accurate to $\pm 0.25\%$ or better.
3. 1X P6101A voltage probe for the 7A13 (010-6101-11).
4. Tektronix 284 Pulse Generator. Substitutions not recommended.
5. Tektronix PG 506 Amplitude Calibrator or equivalent.
6. Tektronix TG 501 Time Mark Generator or similar, if 5 ns and 2 ns markers are included.
7. 2 ns 50-ohm coaxial cable with GR874 connectors (017-0505-00).
8. 42-inch coaxial cables with BNC connectors (012-0057-01). (2 required).
9. GR-to-BNC adapter (017-0064-00).
10. GR-to-BNC adapter (017-0063-00).
11. Plug-in extender cables (067-0616-00) for the 7S14. (2 required).
12. Dual input cable (067-0525-01).
13. 2X 50-ohm attenuator (011-0069-02).
14. 10X 50-ohm attenuator (011-0059-02).
15. 50-ohm variable attenuator (067-0511-00).
16. BNC Tee (103-0030-00).
17. 20 cm 50-ohm air line (017-0084-00).

Preliminary Connections and Set-up

1. Apply power to the 284 Pulse Generator, the 2901 Time Mark Generator and the 067-0508-00 50-ohm Amplitude Calibrator and turn the power switches on.

2. If no adjustments are to be made, insert the 7S14 into the mainframe and ignore the remainder of this step.

Disconnect line power from the 7000 Series oscilloscope mainframe. Plug the 7A13 into the left-hand compartment of the mainframe. Remove the two side panels from the 7S14. Connect the two plug-in extender cables (067-0616-00) to the rear of the 7S14 and connect the opposite end of each extender cable to the oscilloscope mainframe plug-in receptacle that would normally mesh with that particular plug-in connector. Be sure not to connect a right-hand plug to a left-hand receptacle or vice versa. The best way to avoid that possibility is to keep the bottom side of the 7S14 on the surface of your workbench the same as the bottom of the oscilloscope mainframe. Also be sure that the extender cables are installed so the top pins of the 7S14 connectors are joined to the top pins of the corresponding mainframe connectors.

3. Apply power to the oscilloscope mainframe and turn the power switch on. Push the mainframes Vertical Mode RIGHT button and Horizontal Mode A button.

4. Set all the red CAL controls of the 7S14 to the fully counterclockwise, detented position. Check that the word CAL on each control is parallel to the other words on the front panel.

5. Set both the Channel 1 and Channel 2 VOLTS/DIV switches to the .5 V position.

6. Set the DELAYING SWEEP (dark gray) control to the 1 μ s position and the DELAYED SWEEP (light gray) control to the same position.

7. Release all the pushbuttons except the following: CH 1, INT CH 1, HF SYNC, SWP, and REP.

8. Set the SCAN control fully clockwise and the HOLDOFF control fully counterclockwise.

9. If the intensity control and other controls on the mainframe are set correctly, a free-running trace should be visible and positionable with the Channel 1 DC OFFSET control. One or two bright dots in the trace are normal. If

you are not familiar with how to operate the mainframe you may need to refer to the instruction manual(s) for the particular mainframe you are using.

Power Supply Checks

The power supply voltages in the 7S14 should be checked before any internal adjustments are made. However, do not check the supply voltages unless you expect to be making internal adjustments. Power supply checks are not to be considered performance checks. The location of the test points are shown on Fig. 7-1. Measure the supply voltages with the 7A13 and a 1X probe or some accurate DC Voltmeter.

The +50 V, -50 V, and +5 V supplies from the mainframe should be within $\pm 3\%$ of their nominal values when measured at the points of the 7S14 as indicated on Fig. 7-1. If the supplies are not within $\pm 3\%$, mainframe repair or adjustment is needed.

1. Equipment Preparation (After Preliminary Connections and Set-up)

Steps b through f apply to the 7A13.

a. Push the mainframes Vertical Mode LEFT button.

b. Attach a 1X probe (010-6101-01) to the + INPUT terminal and push the + INPUT DC button.

c. Push the V_c button of the - INPUT.

d. Push the 5 MHz BW button.

e. Set the COMPARISON VOLTAGE (V_c) control to 0000 and push the + polarity button.

f. Set the VOLTS/DIV control to .1 V.

g. Touch the tip of the 1X probe to the 7S14 chassis and precisely center the trace on the horizontal centerline of the mainframe graticule, using the 7A13 POSITION control. (This step is necessary, so that a zero volt reference level can be established that will include any voltage drop across the extender cables).

2. Voltage Measurement

Each of the voltages should be measured by setting the COMPARISON VOLTAGE control of the 7A13 to the

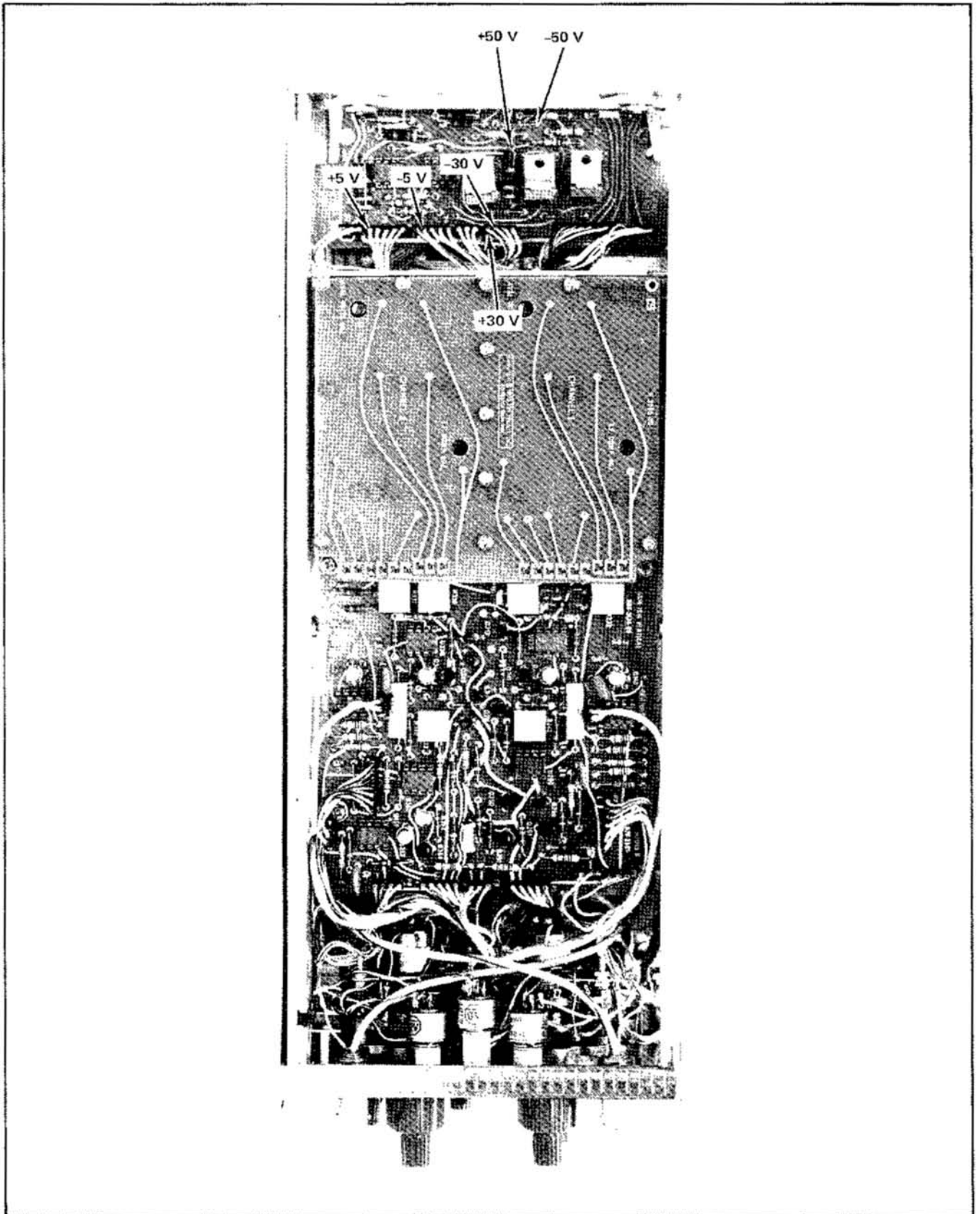

Fig. 7-1. Power Supply Test Points.

Calibration Procedure—7S14

nominal value of the voltage to be measured. Then touch the tip of the 1X probe to the test point for that voltage and center the 7A13 trace with the COMPARISON VOLTAGE control. The measured voltage can then be read on the four digit VOLTS dial. When checking the voltages, push the 7A13 + VOLTS button to measure plus voltages and push the - VOLTS button to measure minus voltages.

NOTE

The +50 V and -50 V supplies are re-regulated in the 7S14 to supply +30 volts, -30 volts, and -5 volts to the 7S14.

- a. Set the 7A13 COMPARISON VOLTAGE control to 50.00 and push the + polarity button.
- b. Connect the 1X probe to the +50 V test point shown on Fig. 7-1 (resistor R615).
- c. Adjust the 7A13 COMPARISON VOLTAGE controls until the trace is returned to the graticule centerline. The value must be within $\pm 3\%$ of 50 V (48.50 to 51.50). Make note of the actual value for use in step g.
- d. Push the - polarity button, attach the probe to the -50 V test point shown on Fig. 7-1 (diode VR613), and check the -50 volt supply in the same manner as the +50 volt supply. Make note of the actual value for use in steps f and k.
- e. Connect the 1X probe to the -30 V test point shown on Fig. 7-1 (Pin 3-2) and set the 7A13 COMPARISON VOLTAGE controls to 30.00.
- f. Adjust the 7A13 COMPARISON VOLTAGE controls until the trace is returned to the graticule centerline. The value must be within 1% of 0.6 the value of the -50 volt supply.
- g. Push the + polarity button, attach the probe to the +30 V test point shown on Fig. 7-1 (Pin 3-1) and check the +30 volt supply in the same manner as the -30 volt supply. The value must be within 1% of 0.6 the value of the +50 volt supply.
- h. Connect the 1X probe to the +5 V test point shown on Fig. 7-1 (Pin 6-1) and set the COMPARISON VOLTAGE controls to 05.00.
- i. Adjust the 7A13 COMPARISON VOLTAGE controls until the trace is returned to the graticule centerline. The value must be within 3% of 5 V (04.85 to 05.15).

- j. Push the - polarity button and attach the probe to the -5 V test point shown on Fig. 7-1 (Pin 5-2).

- k. Adjust the 7A13 COMPARISON VOLTAGE controls until the trace is returned to the graticule centerline. The value must be within 1% of 0.1 the value of the -50 volt supply.

- l. Push the Vertical Mode RIGHT button on the mainframe.

Triggering Checks and Adjustment

1. Equipment Set-up

- a. Release all pushbuttons on the 7S14 except the following: CH 1, INT CH 1, and REP. Set the DELAYING and DELAYED SWEEP controls to $1 \mu\text{s}$. Set the CH 1 VOLTS/DIV to .1 V. Turn the SCAN control fully clockwise and the HOLDOFF control fully counterclockwise. Turn the DELAY ZERO and the DELAY TIME MULT controls completely counterclockwise.

- b. Set the 284 Pulse Generator PERIOD control to $1 \mu\text{s}$ and the SQUARE WAVE AMPLITUDE control to 100 mV. Set the MODE switch to SQUARE WAVE OUTPUT.

- c. Connect a GR-to-BNC adapter (017-0063-00) to the SQUARE WAVE OUTPUT connector of the 284 and attach a 42 inch cable (012-0057-01) between the adapter and the Channel 1 50Ω INPUT connector on the 7S14.

2. Trigger Calibration Check

- a. Adjust the TRIGGERING LEVEL control to trigger on a $1 \mu\text{s}$ square-wave display.

- b. Check that the white dot on the LEVEL control is approximately straight up (between 11 o'clock and 1 o'clock positions).

- c. Push the + SLOPE button and trigger on the same signal with the LEVEL control.

- d. Check that the white dot remains between the 11 and 1 o'clock positions.

- e. If unable to trigger stably under these conditions or if the white dot is not in the region specified for both the + SLOPE and - SLOPE, proceed with the adjustment of R212.

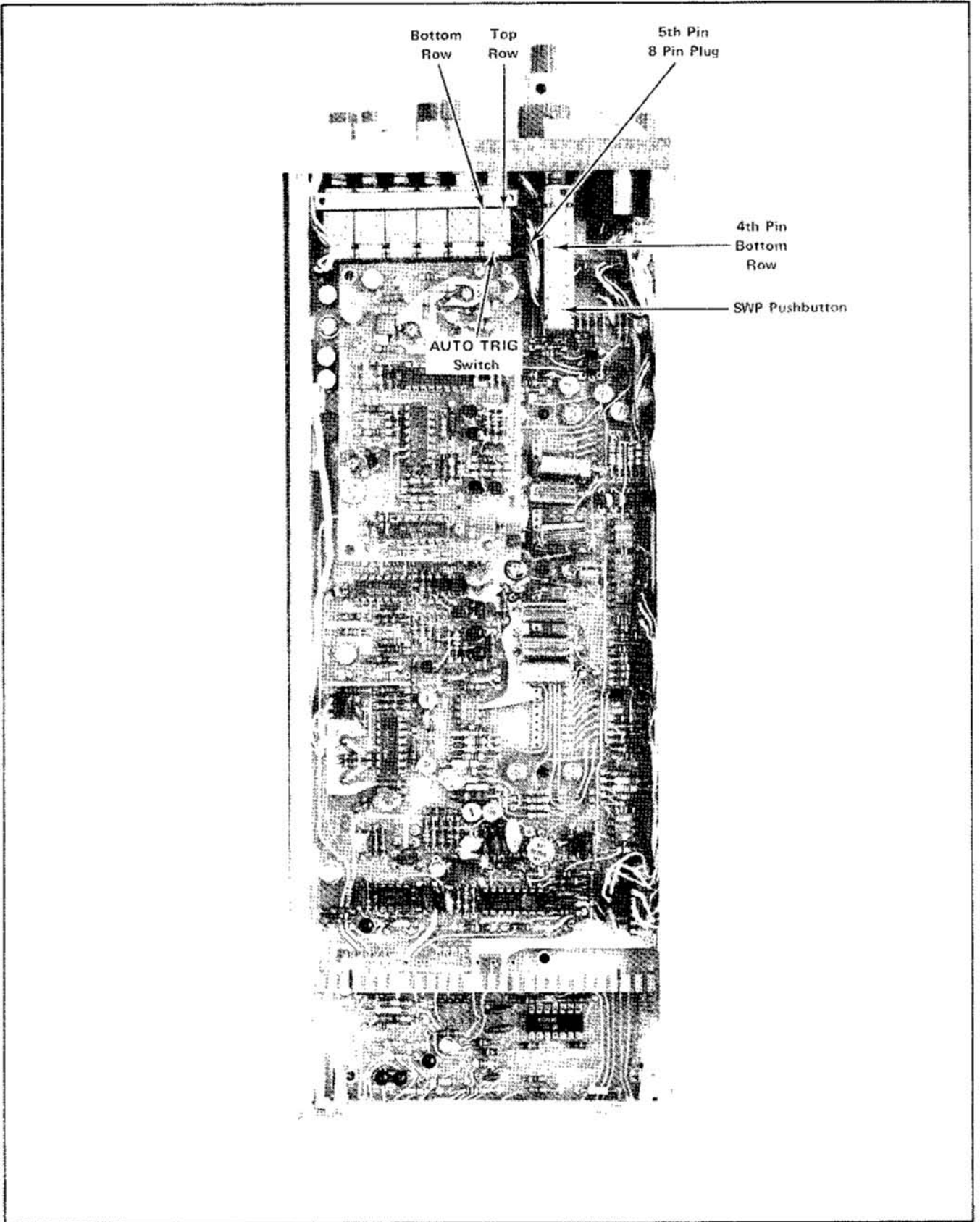

Fig. 7-2. Horizontal Board Test Points.

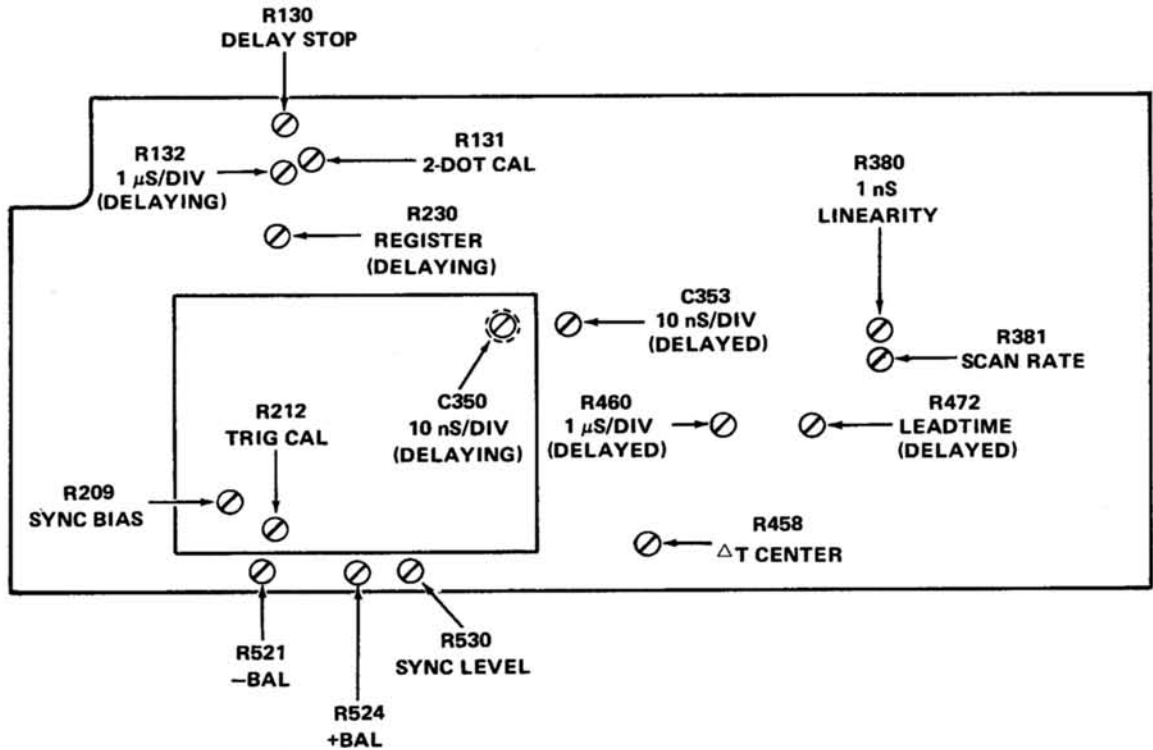

Fig. 7-3. Triggering and Timing Adjustment Locations.

3. Adjustment of R212 (Trig Cal)

- a. Push the DISPLAY button on the 7A13 and set the VOLTS/DIV control to .1.
- b. Push the 7S14 HF SYNC button and adjust R212 (see Fig. 7-3) for a display.
- c. Touch the 1X probe to the 7S14 chassis and adjust the 7A13 POSITION control to locate the free running trace on the horizontal centerline of the graticule.
- d. Touch the 1X probe to pin 1-5 of the Horizontal Board. Pin 1-5 is located just above the AUTO TRIG pushbutton switch. (See Fig. 7-2 - the fifth pin from the front panel is the correct pin.) Adjust the LEVEL control so the free running trace is located on the horizontal centerline of the graticule. If the white dot on the LEVEL control is not located between the 11 and 1 o'clock positions, loosen the control set screw then rotate the control knob and tighten the set screw so the white dot is located at the 12 o'clock position.
- e. Release the 7A13 DISPLAY button and the 7S14 HF SYNC button, then adjust R212 in the middle of the position where the square wave is triggered steadily.

4. Sync Level Check

- a. Set the 284 PERIOD control to 1 ns.
- b. Push the 7S14 HF SYNC and + SLOPE buttons. Set the DELAYING SWEEP control to 10 ns and the DELAYED SWEEP control to 1 ns.
- c. Adjust the 7S14 TRIGGERING LEVEL control to synchronize on a 1 ns sine wave (see Fig. 7-4).
- d. If unable to synchronize on this waveform, adjust R530.

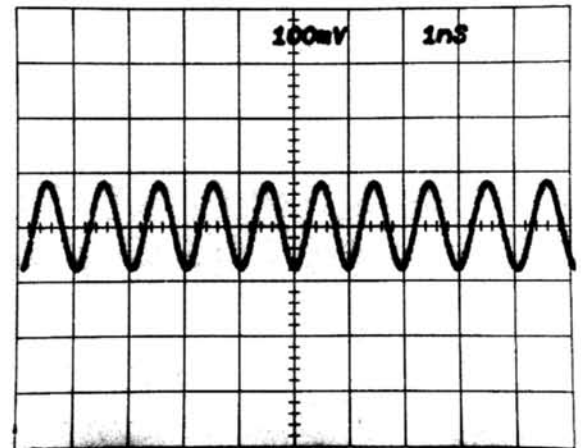

Fig. 7-4. 1 GHz SYNC.

5. Adjustment of R530 (Sync Level)

a. Push the DISPLAY and + buttons on the 7A13; all other pushbuttons must be released. Set the VOLTS/DIV control to 20 m. Attach a 1X probe to the + INPUT terminal.

b. Touch the 1X probe to the base of Q201 (see the Trigger Board schematic and the adjacent board layout for location) and read the DC level (approximately 40 mV).

c. Touch the 1X probe to the base of Q202 and adjust R530 (see Fig. 7-3) to set the DC level of Q202 to match the DC level of Q201.

d. Remove the test probe, release the 7A13 DISPLAY button, and check that it is possible to trigger a waveform (see Fig. 7-4) using the 7S14 LEVEL control.

6. + Balance and – Balance Check

a. Move the cable connection from the Channel 1 INPUT to the EXT INPUT terminal of the 7S14.

b. Connect the TRIGGER OUTPUT signal from the 284 to the Channel 1 INPUT terminal using a coaxial cable (012-0057-01).

c. Set the 284 PERIOD control to 1 μ s.

d. Set both the DELAYING and DELAYED SWEEP controls of the 7S14 to 1 μ s. Release the HF SYNC and the INT CH 1 (not CH 1) pushbuttons.

e. Check that a steady waveform can be displayed by adjusting the TRIGGERING LEVEL control.

NOTE

If, at any point when performing step 6, the results are not as described, perform step 7 before proceeding with the remaining parts of 6.

f. Push the AUTO TRIG button and check that the same steady waveform can be displayed by adjusting the LEVEL control. Change the slope by pushing or releasing the + SLOPE pushbutton and check again.

g. Change the 284 SQUARE WAVE AMPLITUDE from 100 mV to 10 mV and check that a steady waveform can

be displayed using the LEVEL control. Change the slope and check again.

h. Change the 284 PERIOD from 1 μ s to 100 ns and change the 7S14 DELAYING and DELAYED SWEEP controls to .1 μ s. Check that a steady waveform can be displayed using the LEVEL control. Change the slope and check again.

i. Insert a 10X Attenuator (011-0059-02) at the 284 SINE WAVE OUTPUT. Change the 284 PERIOD to 10 ns and the 7S14 DELAYING SWEEP control to 10 ns. Check that a steady waveform can be displayed using either slope. If this check is not satisfactory, adjust R524 and R521 as follows.

7. Adjustment of R524 and R521 (+ Bal and – Bal)

a. Disconnect the cables from the front of the 7S14.

b. Push the 7S14 AUTO TRIG button and turn the TRIGGERING LEVEL control completely clockwise.

c. Push the 7A13 DISPLAY button and set the VOLTS/DIV to 50 m.

d. Touch the 1X probe to the base of Q201 and note the DC level.

e. Touch the 1X probe to the base of Q202 and adjust R524 (see Fig. 7-3) so that the DC level is +60 mV above the DC level of Q201.

f. Turn the TRIGGERING LEVEL control completely counterclockwise.

g. Touch the 1X probe to the base of Q201 and note the DC level.

h. Touch the 1X probe to the base of Q202 and adjust R521 (see Fig. 7-3) so that the DC level is –60 mV below the DC level of Q201.

i. Release the 7A13 DISPLAY button.

8. Sync Bias Check

a. Remove the 10X Attenuator from the 284 and connect a 2X Attenuator (011-0069-02) in its place.

Calibration Procedure—7S14

b. Disconnect the cables from the 7S14 front panel, if not already done, then connect the cable from the 284 SINE WAVE connector to the 7S14 Channel 1 INPUT.

c. Set the 7S14 CH 1 VOLTS/DIV control to 50 mV. Push the INT CH 1 and HF SYNC buttons.

d. Check that a steady waveform can be triggered using the LEVEL control. If not, adjust R209.

9. Adjustment of R209 (Sync Bias)

a. Set the TRIGGERING LEVEL control completely counterclockwise. Preset R209 (see Fig. 7-3) completely counterclockwise.

b. Rotate R209 slowly clockwise until the signal clearly synchronizes. Leave R209 in the fully counterclockwise position if the signal synchronizes there.

Timing Checks and Adjustments

1. Equipment Set-up

a. Release all the 7S14 pushbuttons except the following: CH 1, INT CH 1, SWP, + SLOPE, and REP.

b. Set the CH 1 VOLTS/DIV to .5 V.

c. Set both the DELAYING SWEEP and DELAYED SWEEP controls to 1 μ s.

d. Turn the DELAY ZERO (1st DOT) control completely counterclockwise and set the DELAY TIME MULT (2nd DOT) control to 10.00.

e. Attach a 10X attenuator (011-0059-02) to the MARKER OUTPUT connector on the 2901 Time Mark Generator and connect the output signal to the 7S14 Channel 1 INPUT through a coaxial cable (012-0057-01). Push the 1 μ s MARKER SELECTOR button of the 2901. Set the MARKER AMPLIFIER button to the OFF position.

2. 2-Dot Cal Check

a. Adjust the TRIGGERING LEVEL control for a stable display.

b. Adjust the front panel HORIZ POS control to center the peak of the number one marker on the number one graticule line.

c. Check that there is one marker per division and that the distance between the peak of each marker, from the first through the ninth markers, is less than 0.1 division from the major graticule line (see Fig. 7-5).

d. If this check is not satisfactory, adjust R131.

#1 Graticule Line

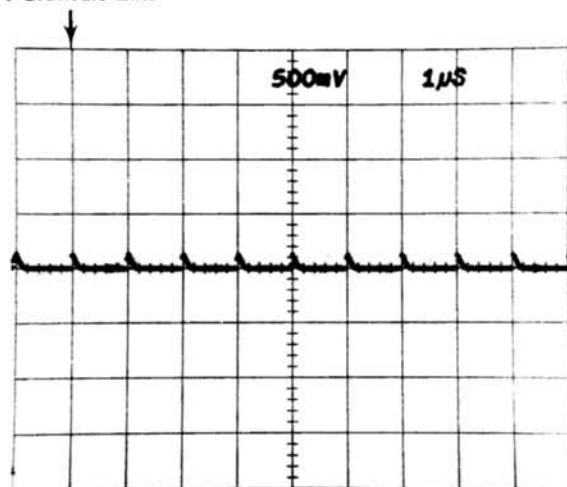

Fig. 7-5. 1 μ s/DIV.

3. Adjustment of R131 (2-Dot Cal)

a. Set the DELAY TIME MULT control to precisely 8.00.

b. Attach a 1X probe (010-0193-00) to the + INPUT of the 7A13. Push the following 7A13 pushbuttons: DISPLAY, 0-10V, +, and the right-hand V_c ; all other pushbuttons must be out. Set the COMPARISON VOLTAGE (V_c) control to 0000.

c. Touch the tip of the 1X probe to the 7S14 chassis and adjust the 7A13 POSITION control so one of the displayed traces is positioned on the horizontal centerline of the mainframe graticule.

d. Set the 7A13 COMPARISON VOLTAGE (V_c) control to precisely 08.00.

e. Touch the tip of the 1X probe to the fourth pin back on the bottom row of pins of the SWP pushbutton (see Fig. 7-2), then adjust R131 (see Fig. 7-3) to position the trace (displayed by the 7A13) on the horizontal centerline of the mainframe graticule.

f. Remove the probe from the test point, release the 7A13 DISPLAY button, and disconnect the cable from the 7S14 INPUT connector.

4. Delay Stop Check

a. Push the 7S14 HF SYNC button, set the SCAN control fully clockwise and set the HOLDOFF control fully counterclockwise.

b. Set both the DELAYING and DELAYED SWEEP controls to 1 μ s.

c. Make sure the DELAY TIME MULT (2nd DOT) control is set to exactly 8.00.

d. If necessary, reduce the intensity of the mainframe so that the two bright dots can be seen.

e. Adjust the DELAY ZERO control so the two bright dots are equal distance from both the left and right edges of the graticule.

f. With a small screwdriver, adjust the front panel SWP CAL control so there is precisely 8 divisions of separation between the two dots.

g. Turn the DELAY ZERO control completely counterclockwise, then adjust the front panel HORIZ POS screwdriver control so the dot is set on the zero graticule line (left-hand edge).

h. Set the DELAY TIME MULT (2nd DOT) control to 10.00 and turn the DELAY ZERO (1st DOT) control completely clockwise.

i. Check that the first (left-hand) bright dot is located on the zero graticule line. If it is not, adjust R130.

5. Adjustment of R130 (Delay Stop)

Adjust R130 (see Fig. 7-3) so that the left-hand dot is at the zero graticule line.

6. 1 μ s/Div Delaying Check

a. Release the 7S14 HF SYNC button.

b. Set the DELAY ZERO control completely counterclockwise and set the DELAY TIME MULT control to 8.00.

c. Reconnect the cable from the 2901 MARKER OUTPUT to the 7S14 Channel 1 INPUT.

d. Adjust the 7S14 TRIGGERING LEVEL control for a display.

e. Check that there is one marker per division displayed (see Fig. 7-5), and that there are exactly 8 divisions between the number one and number nine markers.

f. If these criteria are not met, adjust R132.

7. Adjustment of R132 (1 μ s/Div Delaying)

a. Reduce the mainframe INTENSITY control enough that the two bright dots can be seen.

b. Adjust the DELAY ZERO (1st DOT) control to locate the 1st (left-hand) dot on the first time marker.

c. Adjust R132 (see Fig. 7-3) to set the 2nd (right-hand) dot on the ninth time marker in the same location as the 1st dot is located on the first time marker.

8. 1 μ s/Div Delayed Check

a. Release the SWP pushbutton and set the DELAY TIME MULT controls completely counterclockwise.

b. Increase the mainframe INTENSITY so the waveform is easily seen.

c. Adjust the DELAY ZERO control to center the peak of a marker on the number one graticule line (make sure the DELAYED SWP VAR control is counterclockwise in the detented position).

d. Check that there is one marker per division ± 0.1 division for the following eight markers.

e. If this check is not satisfactory, adjust R460.

9. Adjustment of R460 (1 μ s/Div Delayed)

a. Adjust R460 (see Fig. 7-3) so there is one marker per division (see Fig. 7-5).

b. Rotate the DELAYED SWP VAR (CAL) control completely clockwise and check that there is a separation of 2.5 divisions or more between markers. Return the control to the fully counterclockwise (into detent) position.

10. Scan Rate Check

- a. Push the HF SYNC and REP pushbuttons in. INT CH 1 pushbutton must be out. Set the SCAN control fully clockwise; change the 2901 MARKER SELECTOR to 10ms.
- b. Rotate the SCAN control counterclockwise slowly. Notice that the time markers will slow down, stop drifting in one direction, then start drifting in the other direction. The first point at which the time markers stop drifting and change direction must display three time markers (see Fig. 7-6) for the maximum scan rate to be between 25 and 40 hertz. If there are more or less than three time markers at this point, the adjustment of R381 is required.

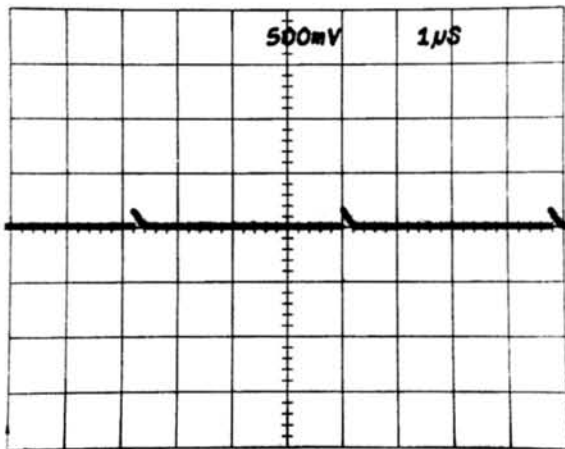

Fig. 7-6. Three 10 ms Markers Per Scan.

11. Adjustment of R381 (Scan Rate)

- a. Rotate the SCAN control to the fully clockwise position.
- b. Adjust R381 (see Fig. 7-3) so that three 10 ms time markers drift across the screen to the right.
- c. Return the SCAN control to the fully clockwise position.

12. Leadtime and Register Check

- a. Release the HF SYNC pushbutton and push the INT CH 1 pushbutton in.
- b. Set both the DELAYING and the DELAYED SWEEP controls to $.2 \mu s$.
- c. Turn the DELAY ZERO control completely counterclockwise and set the DELAY TIME MULT control to 0.00.
- d. Push the 2901 $.1 \mu s$ MARKER SELECTOR button.

e. Adjust the 7S14 TRIGGERING LEVEL control for a stable display.

f. Alternately push and release the SWP pushbutton and check that the first narrow time marker remains between 0.0 and 1.1 divisions from the left edge of the graticule (see Fig. 7-7).

g. If this check is not satisfactory, adjust R472 and R230.

13. Adjustment of R472 and R230 (Leadtime and Register)

- a. Release the SWP pushbutton.
- b. Turn R472 (see Fig. 7-3) to the clockwise extreme, then adjust counterclockwise until a marker is centered on the number one graticule line (see Fig. 7-7).
- c. Push the SWP pushbutton.
- d. Adjust R230 (see Fig. 7-3) so that the first narrow marker (see Fig. 7-7) is precisely centered on the number one graticule line.
- e. Release the SWP pushbutton and repeat parts b through d.

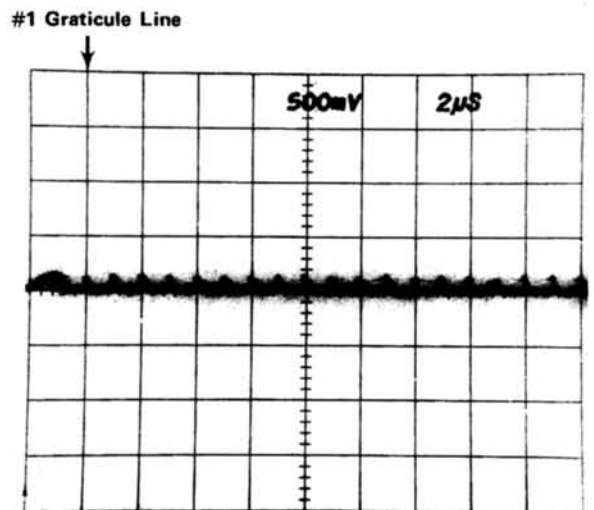

Fig. 7-7. Setting of Leadtime and Registry.

14. Delayed and Delaying Timing Checks

- a. Release the SWP pushbutton.
- b. Check that there are two markers per division and that every second marker is within 0.3 division of the corresponding major graticule line for the first through the ninth division (see Fig. 7-7).

- c. Push the SWP button and repeat part b.
- d. Release the SWP pushbutton.
- e. Set the DELAYING and DELAYED SWEEP controls to 1 μ s. Push the 2901 1 μ s MARKER SELECTOR button and trigger a display using the 7S14 LEVEL control.
- f. Set the DELAY TIME MULT control to precisely 0.00, then adjust the DELAY ZERO control clockwise from its counterclockwise extreme until a time mark is centered on the number one graticule line.
- g. Turn the DELAY TIME MULT control clockwise and observe that the markers move from right to left. Set the DELAY TIME MULT to 1.00 and check that the peak of the marker is within ± 0.1 division of the number one graticule line. Repeat this process with the control set to 2.00, 3.00, 4.00, etc., through 9.00 and check that the peak of each successive marker is within ± 0.1 division of the number one graticule line. Return the DELAY TIME MULT control to 0.00.
- h. Push the SWP button; reduce the intensity on the crt until the intensified dot is visible. With the DELAY ZERO control, set the dot to the first time marker.
- i. Set the DELAY TIME MULT to 1.00 and check that the intensified dot is within ± 0.1 division of the number two marker. Repeat this process with the control set to 2.00, 3.00, 4.00, etc. through 9.00 and check that the intensified dot is within ± 0.1 division of each succeeding time marker. Return the DELAY TIME MULT control to 0.00.

15. 10 ns/Div, Delaying Check

- a. Push the SWP button, set the CH 1 VOLTS/DIV control to .2 V, and set both the DELAYING and DELAYED SWEEP controls to 10 ns.
- b. Push the 2901 10 ns MARKER SELECTOR button.
- c. Adjust the 7S14 TRIGGERING LEVEL control for a stable display.
- d. Check that there is one cycle per division ± 0.2 division for the first through the ninth divisions.
- e. If this check is not satisfactory, adjust C350.

16. Adjustment of C350 (10 ns/Div, Delaying)

- a. Set the DELAY TIME MULT to precisely 8.00.
- b. Reduce the mainframe intensity so the two bright dots can be seen.

c. Adjust the DELAY ZERO control to locate the 1st (left-hand) dot on the first cycle of the display.

d. Adjust C350 (see Fig. 7-3) so the 2nd (right-hand) dot is located on the ninth cycle in the same place as the 1st dot is located on the first cycle.

17. 10 ns/Div, Delayed Check

- a. Increase the mainframe intensity to make the trace easily visible.
- b. Release the SWP button and check for one cycle per division within ± 0.2 divisions for the first through the ninth division.
- c. If this check is not satisfactory, adjust C353.

18. Adjustment of C353 (10 ns/Div, Delayed)

Adjust C353 (see Fig. 7-3) so there is one cycle per division (adjust the DELAY ZERO control to set a reference point).

19. Delayed and Delaying Timing Verification

- a. Set the DELAY TIME MULT to 1.00 and turn the DELAY ZERO control clockwise until the peak of the first cycle is centered on the number one graticule line.
- b. Set the DELAY TIME MULT control to 2.00 and check that the peak of the cycle is within ± 0.1 division of the number one graticule line.
- c. Repeat this process with the control set at 3.00, 4.00, etc., through 9.00 and check that the peak of each successive marker is within ± 0.1 division of the number one graticule line.

20. 1 ns Linearity Check

- a. Disconnect the cable from the 2901 Time Mark Generator and connect it to the 284 Pulse Generator through a GR-to-BNC adapter (017-0064-00).
- b. Set the 284 PERIOD control to 1 ns and set the MODE switch to SINE WAVE OUTPUT.
- c. Set the 7S14 CH 1 VOLTS/DIV to 50 mV. Set the DELAYING SWEEP to 10 ns and the DELAYED SWEEP to 1 ns.

Calibration Procedure—7S14

d. Push the HF SYNC button and adjust the TRIGGERING LEVEL control for a stable display.

e. Check for one cycle per division ± 0.3 division for the first through the ninth divisions.

f. If this check is not satisfactory or if you see any non-linearity in the first few cycles, adjust R380.

21. Adjustment of R380 (1 ns Linearity)

a. Preadjust R380 (see Fig. 7-3) fully clockwise, then rotate counterclockwise very slowly until one or two cycles of non-linearity are off screen to the left. Check for one cycle per division ± 0.3 division for the middle eight divisions.

b. Change the DELAYED SWEEP to 0.5 ns and check for one cycle for every two divisions ± 0.3 division over the middle eight divisions.

c. Change the DELAYED SWEEP to .2 ns and check for one cycle in five divisions ± 0.3 division. You may want to increase the vertical sensitivity.

d. Change the DELAYED SWEEP to 50 .1 ns and check for one cycle in ten divisions ± 0.3 division (see Fig. 7-8).

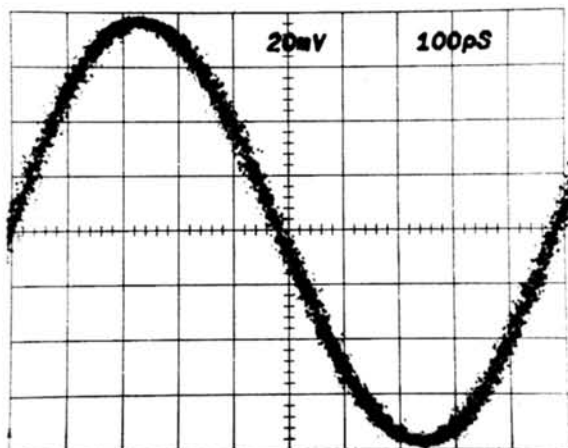

Fig. 7-8. 1 GHz Sinewave at .1 ns/DIV.

Vertical Checks and Adjustments

1. Equipment Set-up

a. Connect the PULSE OUTPUT signal from the 284 Pulse Generator to the Channel 1 INPUT on the 7S14 by means of a 20 cm 50-ohm airline (017-0084-00) and a GR-to-BNC adapter (017-0064-00).

b. Set the 284 Pulse Generator MODE switch to the PULSE OUTPUT position. Set the LEAD TIME switch to the 75 ns position and connect a Coaxial Cable (012-0057-01) between the TRIGGER OUTPUT on the 284 and the EXT INPUT of the 7S14.

c. Release all pushbuttons on the 7S14 except the following: CH 1 (not INT CH 1), +SLOPE and REP.

d. Set the CH 1 and CH 2 VOLTS/DIV to .5 V. Set the DELAYED SWEEP and the DELAYING SWEEP to 10 ns/Div.

e. Set the following controls completely counterclockwise: DELAY ZERO, DELAY TIME MULT, and HOLF-OFF. Set all three red CAL controls counterclockwise into the detented position.

f. Set the SCAN control completely clockwise, position the trace on screen with the CH 1 OFFSET control and trigger on the 284 step signal using the 7S14 LEVEL control.

g. The step signal should be like that shown in Fig. 7-9; if not, try adjusting the 284 TD BIAS control.

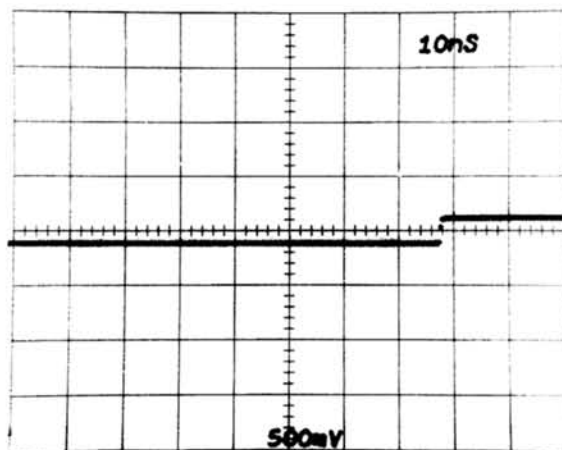

Fig. 7-9. Step Signal from 284 Pulse Generator at .5 V/DIV.

h. Change the CH 1 VOLTS/DIV to 50 mV and center the trace with the CH 1 DC OFFSET control.

i. Position the step signal about one-half division from the left edge of the graticule with the DELAY TIME MULT control.

j. Change the DELAYED SWEEP (light gray) control to 1 ns/Div.

k. Set the red CH 1 VOLTS/DIV variable CAL control so the amplitude of the step is precisely five divisions (see Fig. 7-10).

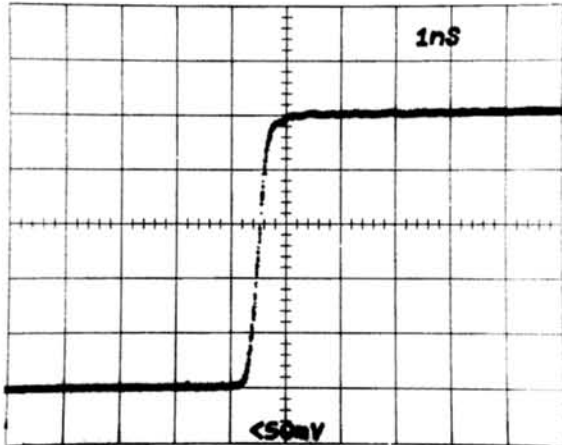

Fig. 7-10. 284 Step Signal. Variable VOLTS/DIV set for 5 divisions.

2. Channel 1 Avalanche Check

a. Position the step so the base is 2.5 divisions below the graticules horizontal centerline.

b. Change the DELAYED SWEEP control to .1 ns and rotate the DELAY TIME MULT control clockwise until the step appears on screen again. The second division below the horizontal centerline represents the 10% level and the second division above the horizontal centerline represents the 90% level.

c. Check that the 10% to 90% risetime is between 300 ps and 350 ps (3 to 3.5 divisions). You may wish to temporarily push the LO NOISE button to reduce time jitter.

d. If the risetime exceeds 350 ps, the following adjustment should be made.

3. Adjustment of R20 (Avalanche for both Channel 1 and Channel 2)

a. Change the DELAYED SWEEP control to 1 ns, the CH 1 VOLTS/DIV to .1, then center the step using the DELAY TIME MULT control. Preset R232 (R331 for CH 2 - see Fig. 7-11) fully counterclockwise.

b. Rotate R20 (see Fig. 7-11) clockwise until the step disappears then counterclockwise until it barely makes a clean display. Note the horizontal position of the bottom corner and set R20 further counterclockwise until the bottom corner moves to the left one-half division. Ignore any vertical movement.

c. Change the VOLTS/DIV to 50 mV again and check the risetime by repeating parts i and j of step 1 and all of step 2. If the risetime still exceeds 3.5 divisions, repeat the above adjustment except this time rotate R20 so the bottom corner moves to the left one full division. It is normal for the trace to move vertically when R20 is being set.

d. Return the VOLTS/DIV control to 50 mV.

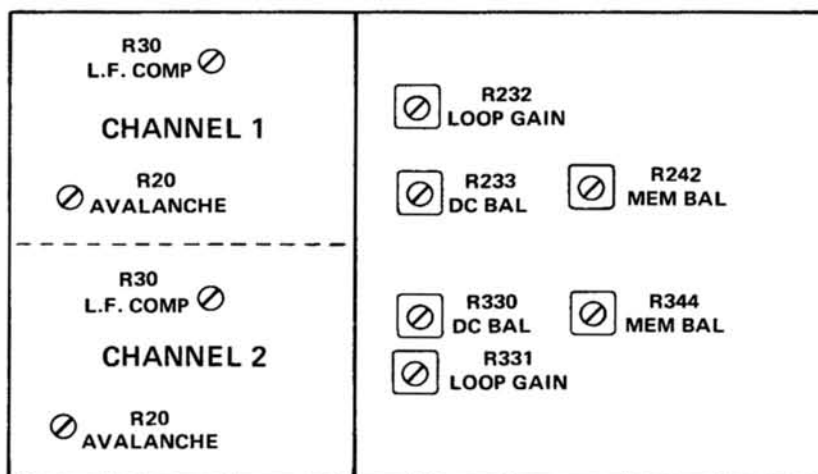

Fig. 7-11. Vertical Adjustment Locations.

Calibration Procedure—7S14

e. Set the DELAYED SWEEP control to 1 ns, center the trace and check that the amplitude of the step is still precisely five divisions (20% per division).

f. Being careful not to move the CH 1 VOLTS/DIV red CAL control, change the VOLTS/DIV control to 5 mV (2% per division) and center the top of the pulse on a graticule line (see Fig. 7-12).

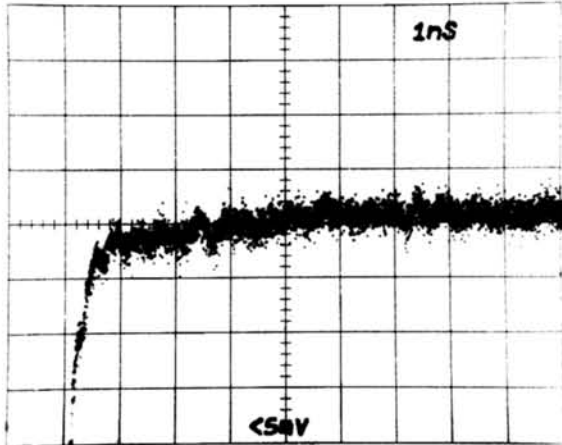

Fig. 7-12. Response to 284 Step Signal at 2% per division.

g. Check that overshoot and ringing does not exceed +1 division to -1.5 divisions (+2% to -3%) in the first 5 ns. The LO NOISE button may be pushed momentarily to help measure the aberrations. Release the LO NOISE pushbutton when finished.

h. Return the VOLTS/DIV to 50 mV and set the red control in the detented CAL position.

4. Channel 2 Avalanche Check

a. Disconnect the cable from the CH 1 INPUT and connect it to the CH 2 INPUT.

b. Push the CH 2 button, set the VOLTS/DIV to 50 mV and repeat step 2 for Channel 2. (Use CH 2 where it states CH 1 in step 2).

c. Remove the 20 cm airline.

5. Delta t Center Check

a. Connect the PULSE OUTPUT signal from the 284 to the center connector on the dual input jumper cable (067-0525-01) by means of a short 50-ohm cable (017-0505-00) and a GR-to-BNC adapter (017-0064-00).

b. Attach the two ends of the dual input cable to the two input channels so the signal is split equally and delivered to the two inputs.

c. Push both the CH 1 - CH 2 TIME DIFF (R139) control alternately from fully clockwise to fully counterclockwise and check that either step may be made to lead the other by at least 1 ns.

d. Rotate the CH 1 - CH 2 pushbuttons for a dual trace display and position the two displays so the base lines coincide.

e. If this check is not satisfactory, adjust R458.

6. Adjustment of R458 (Delta t Center)

a. Adjust R458 (see Fig. 7-4) so the front panel CH 1 - CH 2 TIME DIFF control allows either step to precede the other by nearly the same amount.

b. Push the ADD button and the CH 2 INVERT button.

c. Set the CH 1 - CH 2 TIME DIFF (R139) control for a signal of minimum amplitude.

d. Release the CH 2 INVERT button and disconnect the dual input cable from the 7S14.

7. Channel 1 DC Balance, Loop Gain and Memory Balance Checks

a. Disconnect the short coaxial cable from the 284 PULSE OUTPUT and connect a longer, more convenient cable (012-0057-02) in its place using a GR-to-BNC adapter. Connect the cable to the 7S14 CH 1 INPUT and push the CH 1 button.

b. Push the SWP button and set the time per division of both sweeps to 2 μ s/Div.

c. Check that there is no more than one dot in the abrupt leading positive edge of the step.

NOTE

There will normally be several dots in the leading edge if adjustments were made in step 3.

d. Also check that the position of such a dot is not more than one-half division below the top leading corner of the pulse and not above the top leading corner at all (see Figs. 7-13A, 7-13B and 7-13C).

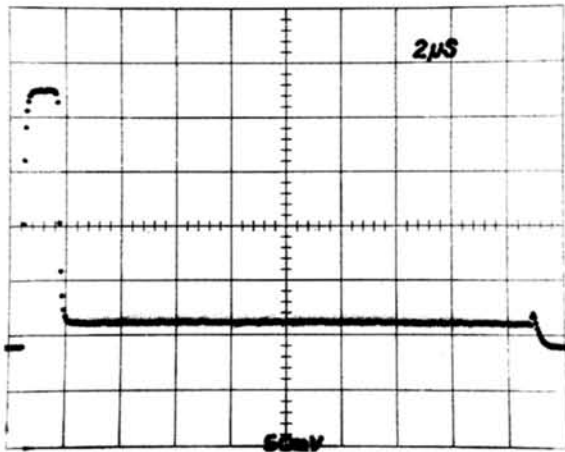

(A) Loop Gain Much Less Than Unity.

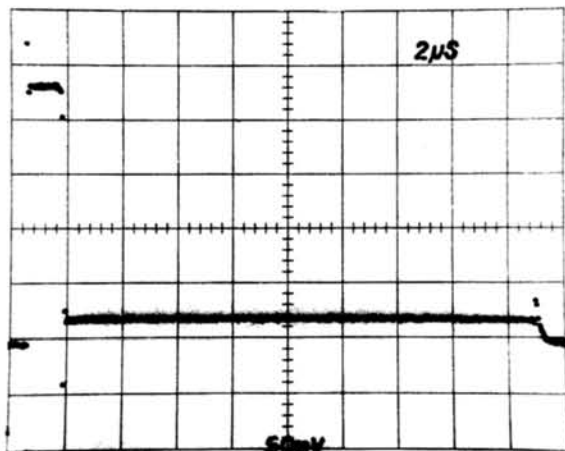

(B) Loop Gain Slightly Greater Than Unity.

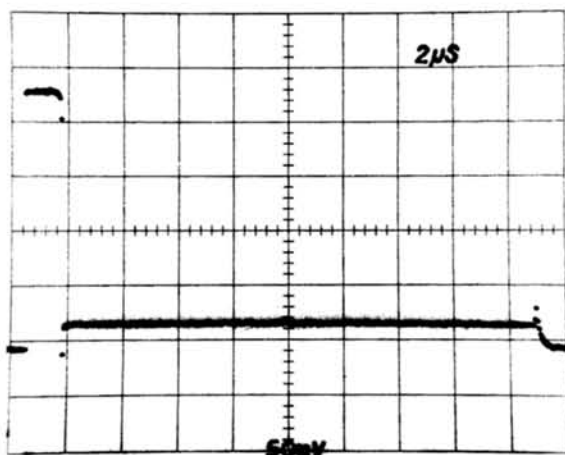

(C) Unity Loop Gain. No dots in Leading Edge or above Top Front Corner.

e. If unable to display the pulse, check the TD Bias adjustment on the front panel of the 284.

f. If the dot is not within one-half division of the top corner, make the following adjustments.

8. Adjustment of R233, R232, and R242 (DC Bal, Loop Gain, and Memory Bal)

a. Change the time per division of both sweeps to 1 μ s. Temporarily disconnect the signal from the CH 1 INPUT. Using two screwdrivers or adjustment tools, one on R232 and one on R233, (see Fig. 7-11), set R233 to minimize vertical movement of the trace while rotating R232 back and forth over the first 90 degrees from the counterclockwise end of its travel. Temporarily set R232 fully counterclockwise.

b. Set the CH 1 VOLTS/DIV to 10 mV. Center the trace and observe the noise. Push the LO NOISE button to see if the trace shifts. Adjust R242 to minimize trace shift between the normal and the LO NOISE position. Release the LO NOISE pushbutton and set the VOLTS/DIV to 50 mV.

c. Change the time per division of both sweeps to 2 μ s. Connect the PULSE OUTPUT of the 284 to the CH 1 INPUT and set R232 so the first dot on the rise is level with the top leading corner of the abrupt positive transition (see Fig. 7-13C).

9. Channel 2 DC Balance, Loop Gain, and Memory Balance Checks

a. Transfer the input signal cable to the CH 2 INPUT.

b. Set the CH 2 VOLTS/DIV to 50 mV and push the CH 2 button.

c. Repeat step 7 (parts c through e) for Channel 2. If the dot is not within one-half division of the top corner, make the following adjustments.

10. Adjustment of R330, R331, and R344 (DC Bal, Loop Gain, and Memory Bal)

a. Change the time per division of both sweeps to 1 μ s. Temporarily disconnect the signal from the CH 2 INPUT. Using two screwdrivers or adjustment tools, one on R331 and one on R330 (see Fig. 7-11), set R330 to minimize vertical movement of the display while rotating R331 back and forth over the first 90 degrees from the counterclockwise end of its travel. Temporarily set R331 fully counterclockwise.

Fig. 7-13.

Calibration Procedure—7S14

b. Set the CH 2 VOLTS/DIV to 10 mV. Center the trace and observe the noise. Push the LO NOISE button to see if the trace shifts. Adjust R344 to minimize trace shift between the normal and the LO NOISE position. Release the LO NOISE pushbutton and set the VOLTS/DIV to 50 mV.

c. Change the time per division of both sweeps to 2 μ s. Connect the PULSE OUTPUT of the 284 to the CH 2 INPUT and set R331 so the first dot on the rise is level with the top leading corner of the abrupt positive transition (see Fig. 7-13C).

11. Trigger Jitter Check

a. Disconnect the cable at the input to Channel 2 and connect it to the input of Channel 1.

b. Push the CH 1 button.

c. Disconnect the trigger cable at the EXT INPUT and push the INT CH 1 button.

d. Set both the DELAYING and DELAYED SWEEP controls to 10 ns and trigger on the step signal.

e. Release the SWP button and set both the DELAY ZERO and the DELAY TIME MULT controls fully counterclockwise. Observe the step signal.

f. Change the DELAYED SWEEP control to .2 ns and keep the display centered using the DELAY TIME MULT dial.

g. Set the TRIGGERING LEVEL control for the least time-jitter on the edge of the step signal using the DELAY TIME MULT control to keep the edge on screen.

h. Change the DELAYED SWEEP control to .1 ns and center the step signal.

i. Change the VOLTS/DIV to 20 mV and check that 80% of the dots are within .3 division (30 ps) horizontally (see Fig. 7-14).

12. Avalanche Recheck

a. Disconnect the cable from the 284 PULSE OUTPUT connector and attach it to the 284 SQUARE WAVE OUTPUT.

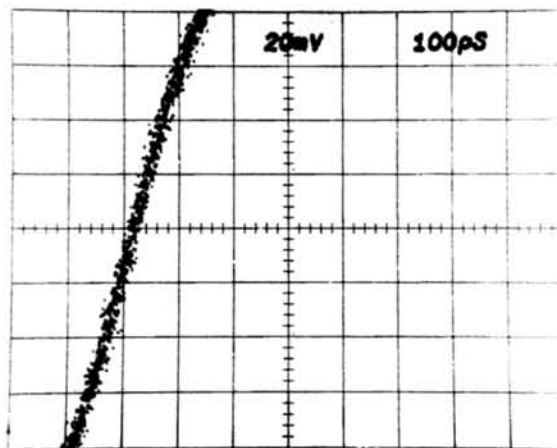

Fig. 7-14. Jitter; 80% of Dots within 0.3 of One Major Division.

b. Slide the 284 MODE switch to the right and select a 100 mV - 1 μ s square-wave output.

c. Connect the other end of the cable to the CH 1 INPUT on the 7S14.

d. Connect the 284 TRIGGER OUTPUT signal to the EXT INPUT of the 7S14 and release the INT CH 1 button.

e. Set the CH 1 VOLTS/DIV to 50 mV and set the red CAL control counterclockwise into the detented position.

f. Set the time per division of both sweeps to 1 μ s and trigger on the display.

g. Check for two divisions of amplitude or set the CH 1 GAIN screwdriver control for two divisions of amplitude.

h. Insert the variable attenuator (067-0511-00) between the 284 output and the CH 1 INPUT, being careful to observe that the proper input and output connections on the attenuator are made.

i. Change the 284 output amplitude to 10 mV, set the variable attenuator (067-0511-00) control fully clockwise and observe the square wave.

j. Disconnect the cable from the 7S14 EXT INPUT connector and push the HF SYNC button. Note the two lines composing the display.

k. Change the CH 1 VOLTS/DIV to 2 mV and center the two bands of noise on the screen.

l. Rotate the (067-0511-00) variable attenuator fully counterclockwise and note the complete merging of the two bands.

m. Set the variable attenuator in such a way that all semblance of special separation between the two bands barely but completely disappears.

n. Change the square-wave amplitude to 100 mV and the 7S14 sensitivity to 10 mV per division.

o. Check that the separation between the centers of the noise bands is no more than two divisions. If noise is excessive, the Avalanche adjustment (R20 for CH 1 or R20 for CH 2) should be repeated or a new avalanche transistor used and the adjustment repeated.

13. Channel 1 L.F. Comparator Check

a. Disconnect the Variable Attenuator and run the 284 SQUARE WAVE OUTPUT directly to the Channel 1 INPUT of the 7S14.

b. Change the square-wave period to 10 μ s.

c. Reconnect the cable from the 284 TRIGGER OUTPUT to the 7S14 EXT INPUT.

d. Release the HF SYNC button, trigger the display and position the top of the waveform to center screen.

e. Check that the top is flat and level within 0.2 division or make the following adjustment.

14. Adjustment of CH 1 R30 (L.F. COMP)

Adjust R30 (see Fig. 7-11) for a flat, level top of the 10 μ s square wave.

15. Channel 2 L.F. Comparator Check

a. Repeat step 12 using the CH 2 INPUT and CH 2 VOLTS/DIV control instead of the Channel 1 control.

b. If the check in step 12, part e is not satisfactory, make the following adjustment.

16. Adjustment of CH 2 R30 (L.F. COMP)

Adjust R30 (see Fig. 7-11) for a flat level top (or bottom) of the 10 μ s square wave.

17. Channel 1 and Channel 2 Amplitude Attenuation Check

a. Change the CH 2 VOLTS/DIV to .1 V and center the display.

b. Rotate the CH 2 red CAL control clockwise and check that the signal amplitude increases by at least 2.5 times. Reset the CAL control in the detented position.

c. Move the input signal cable to the input of Channel 1 and push the CH 1 button.

d. Repeat the check for Channel 1.

18. Channel 1 INPUT Connector Check

a. Disconnect the cable from the 284 SQUARE WAVE OUTPUT and connect it to the OUTPUT of the 50 ohm Amplitude Calibrator (067-0508-00).

b. Disconnect the cable from the 284 TRIGGER OUTPUT and connect it to the TRIGGER OUTPUT of the 50 ohm Amplitude Calibrator.

c. Connect a BNC tee (103-0030-00) to the input of Channel 1 and connect the end of the output cable to the tee.

d. Set the VOLTS switch of the 50 ohm Amplitude Calibrator to .6 and the TEST OPERATE switch to DC.

e. Push the HF SYNC button on the 7S14 and push the mainframe Vertical Mode CHOP button.

f. Set the 7A13 COMPARISON VOLTAGE (V_c) controls to 0000 and the VOLTS/DIV to 50 mV.

g. Push the — INPUT V_c button.

h. Touch the tip of the 1X probe to the shield of the BNC tee and center the trace precisely with the 7A13 POSITION control. It is normal for the trace to shift a little when the probe tip is applied to ground of the 7S14.

i. Touch the tip of the probe to the center conductor of the BNC tee being sure not to let the probe shield touch the shield of the BNC tee.

Calibration Procedure—7S14

j. Rotate the 7A13 COMPARISON VOLTAGE control for a dial reading of 0.600, then precisely center the trace with the COMPARISON VOLTAGE control. Check that the dial reads 0.600 ± 0.006 (0.594 to 0.606). (This checks that the Input resistance is $50 \Omega \pm 2\%$.)

19. Channel 2 INPUT Connector Check

a. Disconnect the BNC tee and cable from Channel 1 and connect it to Channel 2.

b. Push the CH 2 pushbutton and repeat parts h through i of step 18 for Channel 2.

20. Channel 2 Amplitude Check

a. Push the mainframe Vertical Mode RIGHT button.

b. Release all the pushbuttons on the 7S14 except the REP and CH 2 pushbuttons.

c. Set both the CH 1 and CH 2 VOLTS/DIV controls to .2 V and be sure the CAL controls are in the detented CAL positions.

d. Change the Amplitude Calibrator switch from DC to OPERATE and set the VOLTS to 1.2.

e. Trigger a display then center the step using the DELAY TIME MULT control and the DC OFFSET control. The display should appear as shown in Fig. 7-15.

f. Set the front panel CH 2 GAIN control for precisely six divisions of deflection.

g. Change the Amplitude Calibrator VOLTS to 2.0 and the 7S14 CH 2 VOLTS/DIV to .5 V and check for four divisions of deflection $\pm 3\%$.

h. Repeat this process for all other sensitivities of Channel 2 using the correct amount of calibrator voltage

for six divisions of deflection. Use the LO NOISE pushbutton to reduce random noise at the higher sensitivity setting.

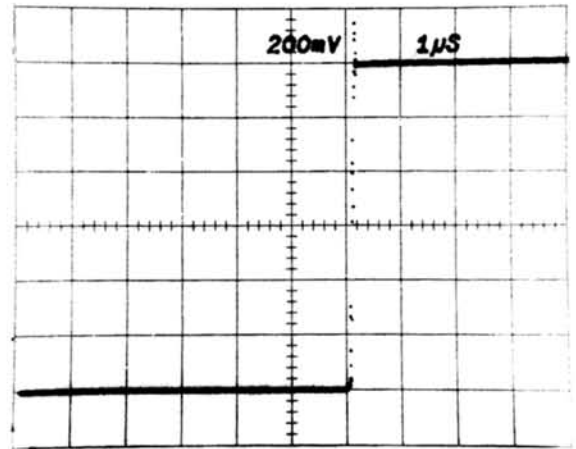

Fig. 7-15. 1.2 Volt Step at .2 VOLTS/DIV.

21. Channel 1 Amplitude Check

a. Release the LO NOISE pushbutton and switch the input cable to Channel 1. (You can remove the BNC tee.)

b. Push the CH 1 button on the 7S14 and set the Amplitude Calibrator VOLTS to 1.2.

c. Set the 7S14 front panel CH 1 GAIN control for precisely six divisions of deflection.

d. Repeat step 19 for Channel 1.

22. Readout Checks

Perform steps 28, 29, 30, and 31 in the ELEMENTARY CHECKS AND INCOMING INSPECTION section if not previously performed.

Place the side panels back on the 7S14.

REPLACEABLE ELECTRICAL PARTS

PARTS ORDERING INFORMATION

Replacement parts are available from or through your local Tektronix, Inc. Field Office or representative.

Changes to Tektronix instruments are sometimes made to accommodate improved components as they become available, and to give you the benefit of the latest circuit improvements developed in our engineering department. It is therefore important, when ordering parts, to include the following information in your order: Part number, instrument type or number, serial number, and modification number if applicable.

If a part you have ordered has been replaced with a new or improved part, your local Tektronix, Inc. Field Office or representative will contact you concerning any change in part number.

Change information, if any, is located at the rear of this manual.

SPECIAL NOTES AND SYMBOLS

X000 Part first added at this serial number
00X Part removed after this serial number

ITEM NAME

In the Parts List, an Item Name is separated from the description by a colon (:). Because of space limitations, an Item Name may sometimes appear as incomplete. For further Item Name identification, the U.S. Federal Cataloging Handbook H6-1 can be utilized where possible.

ABBREVIATIONS

ACTR	ACTUATOR	PLSTC	PLASTIC
ASSY	ASSEMBLY	QTZ	QUARTZ
CAP	CAPACITOR	RECP	RECEPTACLE
CER	CERAMIC	RES	RESISTOR
CKT	CIRCUIT	RF	RADIO FREQUENCY
COMP	COMPOSITION	SEL	SELECTED
CONN	CONNECTOR	SEMICOND	SEMICONDUCTOR
ELCTLT	ELECTROLYTIC	SENS	SENSITIVE
ELEC	ELECTRICAL	VAR	VARIABLE
INCAND	INCANDESCENT	WW	WIREWOUND
LED	LIGHT EMITTING DIODE	XFMR	TRANSFORMER
NONWIR	NON WIREWOUND	XTAL	CRYSTAL

Replaceable Electrical Parts—7S14

CROSS INDEX—MFR. CODE NUMBER TO MANUFACTURER

Mfr. Code	Manufacturer	Address	City, State, Zip
01121	ALLEN-BRADLEY COMPANY	1201 2ND STREET SOUTH	MILWAUKEE, WI 53204
01295	TEXAS INSTRUMENTS, INC. SEMICONDUCTOR GROUP	P.O. BOX 5012	DALLAS, TX 75222
02111	SPECTROL ELECTRONICS CORPORATION	17070 EAST GALE AVENUE	CITY OF INDUSTRY, CA 91745
03508	GENERAL ELECTRIC COMPANY, SEMI-CONDUCTOR PRODUCTS DEPARTMENT	ELECTRONICS PARK	SYRACUSE, NY 13201
03888	KDI PYROFILM CORPORATION	60 S JEFFERSON ROAD	WHIPPANY, NJ 07981
04222	AVX CERAMICS, DIVISION OF AVX CORP.	P O BOX 867	MYRTLE BEACH, SC 29577
04713	MOTOROLA, INC., SEMICONDUCTOR PROD. DIV.	5005 E MCDOWELL RD, PO BOX 20923	PHOENIX, AZ 85036
07263	FAIRCHILD SEMICONDUCTOR, A DIV. OF FAIRCHILD CAMERA AND INSTRUMENT CORP.	464 ELLIS STREET	MOUNTAIN VIEW, CA 94042
12697	CLAROSTAT MFG. CO., INC.	LOWER WASHINGTON STREET	DOVER, NH 03820
14433	ITT SEMICONDUCTORS	3301 ELECTRONICS WAY P O BOX 3049	WEST PALM BEACH, FL 33402
15818	TELEDYNE SEMICONDUCTOR	1300 TERRA BELLA AVE.	MOUNTAIN VIEW, CA 94043
17856	SILICONIX, INC.	2201 LAURELWOOD DRIVE	SANTA CLARA, CA 95054
18324	SIGNETICS CORP.	811 E. ARQUES	SUNNYVALE, CA 94086
24546	CORNING GLASS WORKS, ELECTRONIC COMPONENTS DIVISION	550 HIGH STREET	BRADFORD, PA 16701
24931	SPECIALITY CONNECTOR CO., INC.	2620 ENDRESS PLACE	GREENWOOD, IN 46142
27014	NATIONAL SEMICONDUCTOR CORP.	2900 SEMICONDUCTOR DR.	SANTA CLARA, CA 95051
28480	HEWLETT-PACKARD CO., CORPORATE HQ.	1501 PAGE MILL RD.	PALO ALTO, CA 94304
32997	BOURNS, INC., TRIMPOT PRODUCTS DIV.	1200 COLUMBIA AVE.	RIVERSIDE, CA 92507
51642	CENTRE ENGINEERING INC.	2820 E COLLEGE AVENUE	STATE COLLEGE, PA 16801
56289	SPRAGUE ELECTRIC CO.	87 MARSHALL ST.	NORTH ADAMS, MA 01247
59660	TUSONIX INC.	2155 N FORBES BLVD	TUCSON, AZ 85705
59821	CENTRALAB INC	7158 MERCHANT AVE	EL PASO, TX 79915
72982	SUB NORTH AMERICAN PHILIPS CORP		
73138	ERIE TECHNOLOGICAL PRODUCTS, INC.	644 W. 12TH ST.	ERIE, PA 16512
73899	BECKMAN INSTRUMENTS, INC., HELIPOT DIV.	2500 HARBOR BLVD.	FULLERTON, CA 92634
75042	JFD ELECTRONICS COMPONENTS CORP.	PINETREE ROAD	OXFORD, NC 27565
76493	TRW ELECTRONIC COMPONENTS, IRC FIXED RESISTORS, PHILADELPHIA DIVISION	401 N. BROAD ST.	PHILADELPHIA, PA 19108
80009	BELL INDUSTRIES, INC., MILLER, J. W., DIV.	19070 REYES AVE., P O BOX 5825	COMPTON, CA 90224
82104	TEKTRONIX, INC.	P O BOX 500	BEAVERTON, OR 97077
90303	STANDARD GRIGSBY CO., DIV. OF SUN CHEMICAL CORPORATION	920 RATHBONE AVENUE	AURORA, IL 60507
91293	MALLORY BATTERY COMPANY, DIVISION OF P.R. MALLORY AND COMPANY, INC.	S BROADWAY	TARRYTOWN, NY 10591
91637	JOHANSON MFG. COMPANY	P O BOX 329	BOONTON, NJ 07005
96733	DALE ELECTRONICS, INC.	P. O. BOX 609	COLUMBUS, NE 68601
98291	SAN FERNANDO ELECTRIC MFG CO	1501 FIRST ST	SAN FERNANDO, CA 91341
	SEAELECTRO CORP.	225 HOYT	MAMARONECK, NY 10544

Ckt No.	Tektronix Part No.	Serial/Model No. Eff	Dscont	Name & Description	Mfr Code	Mfr Part Number
A	670-2580-00	B010100	B010145	CKT BOARD ASSY:HORIZONTAL	80009	670-2580-00
A	670-2580-01	B010146	B039999	CKT BOARD ASSY:HORIZONTAL	80009	670-2580-01
A	670-2580-02	B040000	B050428	CKT BOARD ASSY:HORIZONTAL	80009	670-2580-02
A	670-2580-03	B050429	B090944	CKT BOARD ASSY:HORIZONTAL	80009	670-2580-03
A	670-2580-04	B090945		CKT BOARD ASSY:HORIZONTAL	80009	670-2580-04
A	670-2581-00			CKT BOARD ASSY:SIGNAL BYPASS	80009	670-2581-00
A	670-2582-00	B010100	B069999	CKT BOARD ASSY:TRIGGER	80009	670-2582-00
A	670-2582-01	B070000	B090944	CKT BOARD ASSY:TRIGGER	80009	670-2582-01
A	670-2582-02	B090945		CKT BOARD ASSY:TRIGGER	80009	670-2582-02
A	670-2583-00			CKT BOARD ASSY:VERT MODE SW	80009	670-2583-00
A	670-2585-00	B010100	B090944	CKT BOARD ASSY:COMPENSATION	80009	670-2585-00
A	670-2585-01	B090945		CKT BOARD ASSY:COMPENSATION	80009	670-2585-01
A	670-2586-00	B010100	B090944	CKT BOARD ASSY:COMPENSATION	80009	670-2586-00
A	670-2586-01	B090945		CKT BOARD ASSY:COMPENSATION	80009	670-2586-01
A	670-2772-00	B010100	B060493	CKT BOARD ASSY:HORIZONTAL INTERFACE	80009	670-2772-00
A	670-2772-01	B060494		CKT BOARD ASSY:HORIZONTAL INTERFACE	80009	670-2772-01
A	670-2773-00	B010100	B060493	CKT BOARD ASSY:VERTICAL INTERFACE	80009	670-2773-00
A	670-2773-01	B060494		CKT BOARD ASSY:VERTICAL INTERFACE	80009	670-2773-01
A	670-2870-00			CKT BOARD ASSY:READOUT	80009	670-2870-00
A	670-3045-00	B010100	B029999	CKT BOARD ASSY:SAMPLER	80009	670-3045-00
A	670-3045-01	B030000	B079999	CKT BOARD ASSY:SAMPLER	80009	670-3045-01
A	670-3045-02	B080000	B090944	CKT BOARD ASSY:SAMPLER	80009	670-3045-02
A	670-3045-03	B090945	B101284	CKT BOARD ASSY:SAMPLER	80009	670-3045-03
A	670-3045-04	B101285	B121617	CKT BOARD ASSY:SAMPLER	80009	670-3045-04
A	670-3045-05	B121618				
A	670-3051-00			CKT BOARD ASSY:SAMPLER COVER	80009	670-3051-00
BT1	146-0022-00	B010100	B029999	BATTERY, DRY:1.35V,45MAH	90303	WH1-T2
BT1	146-0030-00	B030000		BATTERY, DRY:1.35V,220MAH,TAB LEADS	90303	D 313T2
BT2	146-0022-00	B010100	B029999	BATTERY, DRY:1.35V,45MAH	90303	WH1-T2
BT2	146-0030-00	B030000		BATTERY, DRY:1.35V,220MAH,TAB LEADS	90303	D 313T2
C1	283-0159-00			CAP.,FXD,CER DI:18PF,5%,50V	51642	T150-050NP0180J
C2	283-0159-00			CAP.,FXD,CER DI:18PF,5%,50V	51642	T150-050NP0180J
C10	283-0028-00			CAP.,FXD,CER DI:0.0022UF,20%,50V	59660	0805585Y5SO222M
C11	283-0325-00			CAP.,FXD,CER DI:47PF,10%,100V	04222	10051A470KA2065
C12	283-0325-00			CAP.,FXD,CER DI:47PF,10%,100V	04222	10051A470KA2065
C13	283-0121-00			CAP.,FXD,CER DI:0.001UF,20%,200V	56289	40C73A5
C22	283-0121-00			CAP.,FXD,CER DI:0.001UF,20%,200V	56289	40C73A5
C30	283-0175-00			CAP.,FXD,CER DI:10PF,5%,200V	96733	TDR43BY100DP
C45	283-0107-00	B010100	B090944	CAP.,FXD,CER DI:51PF,5%,200V	96733	R3017
C45	283-0281-00	B090945	B101284	CAP.,FXD,CER DI:500PF,10%,50V	51642	RB060050X5R500K
C45	283-0432-00	B101285		CAP.,FXD,CER DI:51 PF,5%,50V	91293	500R15N410JB
C50	283-0309-00			CAP.,FXD,CER DI:150PF,10%,50V	04222	ULA355A151K1T60
C51	283-0309-00			CAP.,FXD,CER DI:150PF,10%,50V	04222	ULA355A151K1T60
C52	283-0309-00			CAP.,FXD,CER DI:150PF,10%,50V	04222	ULA355A151K1T60
C53	283-0309-00			CAP.,FXD,CER DI:150PF,10%,50V	04222	ULA355A151K1T60
C54	283-0309-00			CAP.,FXD,CER DI:150PF,10%,50V	04222	ULA355A151K1T60
C55	283-0309-00			CAP.,FXD,CER DI:150PF,10%,50V	04222	ULA355A151K1T60
C56	283-0309-00			CAP.,FXD,CER DI:150PF,10%,50V	04222	ULA355A151K1T60
C57	283-0309-00			CAP.,FXD,CER DI:150PF,10%,50V	04222	ULA355A151K1T60
C58	283-0309-00			CAP.,FXD,CER DI:150PF,10%,50V	04222	ULA355A151K1T60
C59	283-0309-00			CAP.,FXD,CER DI:150PF,10%,50V	04222	ULA355A151K1T60
C60	283-0309-00			CAP.,FXD,CER DI:150PF,10%,50V	04222	ULA355A151K1T60

Replaceable Electrical Parts—7S14

Ckt No.	Tektronix Part No.	Serial/Model No.		Name & Description	Mfr Code	Mfr Part Number
		Eff	Dscont			
C61	283-0309-00			CAP.,FXD,CER DI:150PF,10%,50V	04222	ULA355A151K1T60
C62	283-0309-00			CAP.,FXD,CER DI:150PF,10%,50V	04222	ULA355A151K1T60
C63	283-0309-00			CAP.,FXD,CER DI:150PF,10%,50V	04222	ULA355A151K1T60
C64	283-0309-00			CAP.,FXD,CER DI:150PF,10%,50V	04222	ULA355A151K1T60
C65	283-0309-00			CAP.,FXD,CER DI:150PF,10%,50V	04222	ULA355A151K1T60
C66	283-0309-00			CAP.,FXD,CER DI:150PF,10%,50V	04222	ULA355A151K1T60
C67	283-0309-00			CAP.,FXD,CER DI:150PF,10%,50V	04222	ULA355A151K1T60
C68	283-0309-00			CAP.,FXD,CER DI:150PF,10%,50V	04222	ULA355A151K1T60
C69	283-0309-00			CAP.,FXD,CER DI:150PF,10%,50V	04222	ULA355A151K1T60
C74	283-0108-00			CAP.,FXD,CER DI:220PF,10%,200V	56289	1C10C0G221K200B
C75	283-0133-00			CAP.,FXD,CER DI:5PF,5%,50V	72982	8300 002C0H0509C
C76	283-0132-00			CAP.,FXD,CER DI:10PF,5%,50V	72982	8300008C0H0100J
C80	283-0156-00			CAP.,FXD,CER DI:1000PF,+100-0%,200V	96733	R2670
C84	283-0108-00			CAP.,FXD,CER DI:220PF,10%,200V	56289	1C10C0G221K200B
C85	283-0133-00			CAP.,FXD,CER DI:5PF,5%,50V	72982	8300 002C0H0509C
C86	283-0132-00			CAP.,FXD,CER DI:10PF,5%,50V	72982	8300008C0H0100J
C90	283-0156-00			CAP.,FXD,CER DI:1000PF,+100-0%,200V	96733	R2670
C120	283-0051-00			CAP.,FXD,CER DI:0.0033UF,5%,100V	56289	1C20C0G332J100B
C173	283-0000-00			CAP.,FXD,CER DI:0.001UF,+100-0%,500V	59660	831610Y5U0102P
C190	283-0080-00			CAP.,FXD,CER DI:0.022UF,+80-20%,25V	59821	2DDU60E223Z
C200	290-0534-00			CAP.,FXD,ELCTLT:1UF,20%,35V	56289	196D105X0035HA1
C201	283-0003-00			CAP.,FXD,CER DI:0.01UF,+80-20%,150V	59821	2DDH66J103Z
C202	283-0111-00			CAP.,FXD,CER DI:0.1UF,20%,50V	56289	273C11
C210	283-0182-00			CAP.,FXD,CER DI:51PF,5%,400V	72982	8121N400A510J
C212	283-0182-00	B010100	B069999	CAP.,FXD,CER DI:51PF,5%,400V	72982	8121N400A510J
C212	283-0069-00	B070000		CAP.,FXD,CER DI:15PF,20%,50V	51642	A150050NPU150M
C213	283-0181-00			CAP.,FXD,CER DI:1.8PF,10%,100V	59660	8101B121COKO189B
C214	283-0121-00			CAP.,FXD,CER DI:0.001UF,20%,200V	56289	40C73A5
C220	283-0111-00			CAP.,FXD,CER DI:0.1UF,20%,50V	56289	273C11
C222	290-0534-00			CAP.,FXD,ELCTLT:1UF,20%,35V	56289	196D105X0035HA1
C223	283-0252-00			CAP.,FXD,CER DI:1000PF,10%,50V	04222	ULA105C102K2T60
C239	295-0162-00			CAP.SET.MTCHD:1UF,0.009950UF,950PF,0.1UF INDIVIDUAL TIMING CAPACITORS IN THIS ASSEMBLY MUST BE ORDERED BY THE 9 DIGIT PART NUMBER, LETTER SUFFIX AND TOLERANCE PRINTED ON THE TIMING CAPACITOR TO BE REPLACED. THE LETTER SUFFIX AND TOLERANCE SHOULD BE THE SAME FOR ALL OF THE TIMING CAPACITORS IN THE ASSEMBLY)	80009	295-0162-00
C240	283-0111-00			CAP.,FXD,CER DI:0.1UF,20%,50V	56289	273C11
C241	-----			(PART OF C239)		
C242	290-0534-00	B010100	B069999	CAP.,FXD,ELCTLT:1UF,20%,35V	56289	196D105X0035HA1
C243	-----			(PART OF C239)		
C244	-----			(PART OF C239)		
C245	283-0000-00			CAP.,FXD,CER DI:0.001UF,+100-0%,500V	59660	831610Y5U0102P
C247	283-0164-00			CAP.,FXD,CER DI:2.2UF,20%,25V	04222	SR402E225MAA
C248	285-0566-00			CAP.,FXD,PLSTC:0.022UF,10%,200V	56289	192P22392
C249	283-0159-00			CAP.,FXD,CER DI:18PF,5%,50V	51642	T150-050NP0180J
C250	283-0010-00			CAP.,FXD,CER DI:0.05UF,+100-20%,50V	56289	1C10Z5U503Z050B
C251	283-0198-00			CAP.,FXD,CER DI:0.22UF,20%,50V	56289	1C10Z5U223M050B
C252	283-0107-00			CAP.,FXD,CER DI:51PF,5%,200V	96733	R3017
C253	283-0107-00			CAP.,FXD,CER DI:51PF,5%,200V	96733	R3017

Ckt No.	Tektronix Part No.	Serial/Model No. Eff	Dscont	Name & Description	Mfr Code	Mfr Part Number
C254	295-0162-00			CAP.SET,MTCHD:1UF,0.009950UF,950PF,0.1UF	80009	295-0162-00
C255	-----			(PART OF C254)		
C257	-----			(PART OF C254)		
C260	-----			(PART OF C254)		
C262	290-0534-00	B010100	B069999	CAP.,FXD,ELCTLT:1UF,20%,35V	56289	196D105X0035HA1
C270	283-0252-00	B070000		CAP.,FXD,CER DI:1000PF,10%,50V	04222	ULA105C102K2T60
C271	290-0354-00	B070000		CAP.,FXD,ELCTLT:1UF,20%,35V	56289	196D105X0035HA1
C280	283-0111-00			CAP.,FXD,CER DI:0.1UF,20%,50V	56289	273C11
C281	283-0003-00			CAP.,FXD,CER DI:0.01UF,+80-20%,150V	59821	2DDH66J103Z
C290	283-0111-00			CAP.,FXD,CER DI:0.1UF,20%,50V	56289	273C11
C291	283-0003-00			CAP.,FXD,CER DI:0.01UF,+80-20%,150V	59821	2DDH66J103Z
C292	290-0512-00			CAP.,FXD,ELCTLT:22UF,20%,15V	56289	196D226X0015KA1
C310	290-0534-00			CAP.,FXD,ELCTLT:1UF,20%,35V	56289	196D105X0035HA1
C320	283-0058-00			CAP.,FXD,CER DI:0.027UF,10%,100V	56289	1C20X7R273K100B
C322	283-0003-00			CAP.,FXD,CER DI:0.01UF,+80-20%,150V	59821	2DDH66J103Z
C330	290-0534-00			CAP.,FXD,ELCTLT:1UF,20%,35V	56289	196D105X0035HA1
C331	283-0028-00			CAP.,FXD,CER DI:0.0022UF,20%,50V	59660	0805585Y5SO222M
C332	283-0003-00			CAP.,FXD,CER DI:0.01UF,+80-20%,150V	59821	2DDH66J103Z
C333	290-0534-00			CAP.,FXD,ELCTLT:1UF,20%,35V	56289	196D105X0035HA1
C334	290-0534-00			CAP.,FXD,ELCTLT:1UF,20%,35V	56289	196D105X0035HA1
C335	290-0534-00			CAP.,FXD,ELCTLT:1UF,20%,35V	56289	196D105X0035HA1
C336	283-0110-00			CAP.,FXD,CER DI:0.005UF,+80-20%,150V	59660	855-547-E-502Z
C340	290-0534-00			CAP.,FXD,ELCTLT:1UF,20%,35V	56289	196D105X0035HA1
C341	283-0159-00			CAP.,FXD,CER DI:18PF,5%,50V	51642	T150-050NP0180J
C342	290-0534-00			CAP.,FXD,ELCTLT:1UF,20%,35V	56289	196D105X0035HA1
C343	283-0003-00			CAP.,FXD,CER DI:0.01UF,+80-20%,150V	59821	2DDH66J103Z
C350	281-0123-00	B010100	B039999	CAP.,VAR,CER DI:5-25PF,100V	59660	518-000A5-25
C350	281-0158-00	B040000		CAP.,VAR,CER DI:7-45PF,50V	73899	DVJ-5006
C351	283-0003-00			CAP.,FXD,CER DI:0.01UF,+80-20%,150V	59821	2DDH66J103Z
C352	283-0003-00			CAP.,FXD,CER DI:0.01UF,+80-20%,150V	59821	2DDH66J103Z
C353	281-0123-00	B010100	B039999	CAP.,VAR,CER DI:5-25PF,100V	59660	518-000A5-25
C353	281-0158-00	B040000		CAP.,VAR,CER DI:7-45PF,50V	73899	DVJ-5006
C354	281-0593-00			CAP.,FXD,CER DI:3.9PF,10%,500V	04222	7001-C0J-3R9C
C360	283-0028-00			CAP.,FXD,CER DI:0.0022UF,20%,50V	59660	0805585Y5SO222M
C361	283-0003-00			CAP.,FXD,CER DI:0.01UF,+80-20%,150V	59821	2DDH66J103Z
C380	283-0115-00			CAP.,FXD,CER DI:47PF,5%,200V	59660	805-519-COG0470J
C381	283-0060-00			CAP.,FXD,CER DI:100PF,5%,200V	59660	855-535U2J101J
C382	283-0077-00			CAP.,FXD,CER DI:330PF,5%,500V	59660	831-500B331J
C383	283-0095-00			CAP.,FXD,CER DI:56PF,10%,200V	59660	855-536-COG0560K
C390	283-0028-00			CAP.,FXD,CER DI:0.0022UF,20%,50V	59660	0805585Y5SO222M
C420	283-0000-00			CAP.,FXD,CER DI:0.001UF,+100-0%,500V	59660	831610Y5U0102P
C430	283-0003-00			CAP.,FXD,CER DI:0.01UF,+80-20%,150V	59821	2DDH66J103Z
C438	283-0003-00			CAP.,FXD,CER DI:0.01UF,+80-20%,150V	59821	2DDH66J103Z
C440	283-0164-00			CAP.,FXD,CER DI:2.2UF,20%,25V	04222	SR402E225MAA
C441	285-0566-00			CAP.,FXD,PLSTC:0.022UF,10%,200V	56289	192P22392
C465	283-0003-00			CAP.,FXD,CER DI:0.01UF,+80-20%,150V	59821	2DDH66J103Z
C471	283-0107-00			CAP.,FXD,CER DI:51PF,5%,200V	96733	R3017
C474	283-0080-00			CAP.,FXD,CER DI:0.022UF,+80-20%,25V	59821	2DDU60E223Z
C480	283-0000-00			CAP.,FXD,CER DI:0.001UF,+100-0%,500V	59660	831610Y5U0102P
C481	283-0000-00			CAP.,FXD,CER DI:0.001UF,+100-0%,500V	59660	831610Y5U0102P
C490	283-0003-00			CAP.,FXD,CER DI:0.01UF,+80-20%,150V	59821	2DDH66J103Z
C491	283-0000-00			CAP.,FXD,CER DI:0.001UF,+100-0%,500V	59660	831610Y5U0102P
C492	283-0077-00			CAP.,FXD,CER DI:330PF,5%,500V	59660	831-500B331J
C520	283-0111-00			CAP.,FXD,CER DI:0.1UF,20%,50V	56289	273C11

Replaceable Electrical Parts—7S14

Ckt No.	Tektronix Part No.	Serial/Model No.		Name & Description	Mfr Code	Mfr Part Number
		Eff	Dscont			
C521	283-0000-00			CAP.,FXD,CER DI:0.001UF,+100-0%,500V	59660	831610Y5U0102P
C530	290-0534-00			CAP.,FXD,ELCTLT:1UF,20%,35V	56289	196D105X0035HA1
C531	283-0003-00			CAP.,FXD,CER DI:0.01UF,+80-20%,150V	59821	2DDH66J103Z
C550	290-0534-00			CAP.,FXD,ELCTLT:1UF,20%,35V	56289	196D105X0035HA1
C560	290-0523-00			CAP.,FXD,ELCTLT:2.2UF,20%,20V	56289	196D225X0020HA1
C561	283-0000-00			CAP.,FXD,CER DI:0.001UF,+100-0%,500V	59660	831610Y5U0102P
C562	283-0000-00			CAP.,FXD,CER DI:0.001UF,+100-0%,500V	59660	831610Y5U0102P
C570	290-0534-00			CAP.,FXD,ELCTLT:1UF,20%,35V	56289	196D105X0035HA1
C590	283-0080-00			CAP.,FXD,CER DI:0.022UF,+80-20%,25V	59821	2DDU60E223Z
C710	283-0060-00			CAP.,FXD,CER DI:100PF,5%,200V	59660	855-535U2J101J
C711	283-0060-00			CAP.,FXD,CER DI:100PF,5%,200V	59660	855-535U2J101J
C712	283-0000-00			CAP.,FXD,CER DI:0.001UF,+100-0%,500V	59660	831610Y5U0102P
C730	283-0114-00			CAP.,FXD,CER DI:0.0015UF,5%,200V	59660	805534Y5DO152J
C740	283-0114-00			CAP.,FXD,CER DI:0.0015UF,5%,200V	59660	805534Y5DO152J
CR1	152-0572-00			SEMICONV DEVICE:BRIDGE,SAMPLE GATE	80009	152-0572-00
CR3	152-0008-00	B060494		SEMICONV DEVICE:GERMANIUM,75V,60MA	14433	G1409
CR5	152-0141-02	B060494		SEMICONV DEVICE:SILICON,30V,150MA	01295	1N4152R
CR10	152-0141-02			SEMICONV DEVICE:SILICON,30V,150MA	01295	1N4152R
CR20	152-0141-02			SEMICONV DEVICE:SILICON,30V,150MA	01295	1N4152R
CR120	152-0141-02			SEMICONV DEVICE:SILICON,30V,150MA	01295	1N4152R
CR121	152-0141-02			SEMICONV DEVICE:SILICON,30V,150MA	01295	1N4152R
CR122	152-0141-02			SEMICONV DEVICE:SILICON,30V,150MA	01295	1N4152R
CR123	152-0141-02			SEMICONV DEVICE:SILICON,30V,150MA	01295	1N4152R
CR150	152-0141-02			SEMICONV DEVICE:SILICON,30V,150MA	01295	1N4152R
CR161	152-0141-02			SEMICONV DEVICE:SILICON,30V,150MA	01295	1N4152R
CR171	152-0141-02			SEMICONV DEVICE:SILICON,30V,150MA	01295	1N4152R
CR172	152-0141-02			SEMICONV DEVICE:SILICON,30V,150MA	01295	1N4152R
CR220	152-0177-00			SEMICONV DEVICE:TUNNEL,10MA,4PF	80009	152-0177-00
CR221	152-0070-00			SEMICONV DEVICE:GE,0.1MA,3PF	03508	BD4
CR222	152-0141-02			SEMICONV DEVICE:SILICON,30V,150MA	01295	1N4152R
CR223	152-0141-02			SEMICONV DEVICE:SILICON,30V,150MA	01295	1N4152R
CR224	152-0141-02			SEMICONV DEVICE:SILICON,30V,150MA	01295	1N4152R
CR225	152-0141-02			SEMICONV DEVICE:SILICON,30V,150MA	01295	1N4152R
CR240	152-0323-00	B010100	B069999	SEMICONV DEVICE:SILICON,35V,0.1A	80009	152-0323-00
CR242	152-0141-02			SEMICONV DEVICE:SILICON,30V,150MA	01295	1N4152R
CR250	152-0323-00	B010100	B069999	SEMICONV DEVICE:SILICON,35V,0.1A	80009	152-0323-00
CR280	152-0141-02			SEMICONV DEVICE:SILICON,30V,150MA	01295	1N4152R
CR342	152-0141-02			SEMICONV DEVICE:SILICON,30V,150MA	01295	1N4152R
CR353	152-0141-02			SEMICONV DEVICE:SILICON,30V,150MA	01295	1N4152R
CR360	152-0141-02			SEMICONV DEVICE:SILICON,30V,150MA	01295	1N4152R
CR381	152-0141-02			SEMICONV DEVICE:SILICON,30V,150MA	01295	1N4152R
CR390	152-0141-02	B010100	B069999	SEMICONV DEVICE:SILICON,30V,150MA	01295	1N4152R
CR420	152-0075-00			SEMICONV DEVICE:GE,25V,40MA	14433	G866
CR421	152-0075-00			SEMICONV DEVICE:GE,25V,40MA	14433	G866
CR440	152-0075-00			SEMICONV DEVICE:GE,25V,40MA	14433	G866
CR450	152-0075-00			SEMICONV DEVICE:GE,25V,40MA	14433	G866
CR451	152-0141-02			SEMICONV DEVICE:SILICON,30V,150MA	01295	1N4152R
CR459	152-0169-00			SEMICONV DEVICE:TUNNEL,1MA,10PF	03508	STD962
CR460	152-0153-00	B010100	B090944	SEMICONV DEVICE:SILICON,15V,50MA	07263	FD7003
CR460	152-0457-00	B090945		SEMICONV DEVICE:SILICON,25V	28480	5082-2068
CR461	152-0153-00	B010100	B090944	SEMICONV DEVICE:SILICON,15V,50MA	07263	FD7003
CR461	152-0457-00	B090945		SEMICONV DEVICE:SILICON,25V	28480	5082-2068
CR462	152-0075-00			SEMICONV DEVICE:GE,25V,40MA	14433	G866

Ckt No.	Tektronix	Serial/Model No.		Name & Description	Mfr	Mfr Part Number
	Part No.	Eff	Dscont		Code	
CR480	152-0141-02			SEMICON D DEVICE:SILICON,30V,150MA	01295	1N4152R
CR490	152-0141-02			SEMICON D DEVICE:SILICON,30V,150MA	01295	1N4152R
CR491	152-0141-02			SEMICON D DEVICE:SILICON,30V,150MA	01295	1N4152R
CR550	152-0141-02			SEMICON D DEVICE:SILICON,30V,150MA	01295	1N4152R
CR700	152-0141-02			SEMICON D DEVICE:SILICON,30V,150MA	01295	1N4152R
CR710	152-0141-02			SEMICON D DEVICE:SILICON,30V,150MA	01295	1N4152R
CR811	152-0141-02			SEMICON D DEVICE:SILICON,30V,150MA	01295	1N4152R
CR812	152-0141-02			SEMICON D DEVICE:SILICON,30V,150MA	01295	1N4152R
CR813	152-0141-02			SEMICON D DEVICE:SILICON,30V,150MA	01295	1N4152R
CR814	152-0141-02			SEMICON D DEVICE:SILICON,30V,150MA	01295	1N4152R
CR815	152-0141-02			SEMICON D DEVICE:SILICON,30V,150MA	01295	1N4152R
CR816	152-0141-02			SEMICON D DEVICE:SILICON,30V,150MA	01295	1N4152R
CR817	152-0141-02			SEMICON D DEVICE:SILICON,30V,150MA	01295	1N4152R
CR821	152-0141-02			SEMICON D DEVICE:SILICON,30V,150MA	01295	1N4152R
CR822	152-0141-02			SEMICON D DEVICE:SILICON,30V,150MA	01295	1N4152R
CR823	152-0141-02			SEMICON D DEVICE:SILICON,30V,150MA	01295	1N4152R
CR824	152-0141-02			SEMICON D DEVICE:SILICON,30V,150MA	01295	1N4152R
CR825	152-0141-02			SEMICON D DEVICE:SILICON,30V,150MA	01295	1N4152R
CR826	152-0141-02			SEMICON D DEVICE:SILICON,30V,150MA	01295	1N4152R
CR871	152-0141-02			SEMICON D DEVICE:SILICON,30V,150MA	01295	1N4152R
CR872	152-0141-02			SEMICON D DEVICE:SILICON,30V,150MA	01295	1N4152R
CR873	152-0141-02			SEMICON D DEVICE:SILICON,30V,150MA	01295	1N4152R
CR874	152-0141-02			SEMICON D DEVICE:SILICON,30V,150MA	01295	1N4152R
CR875	152-0141-02			SEMICON D DEVICE:SILICON,30V,150MA	01295	1N4152R
CR876	152-0141-02			SEMICON D DEVICE:SILICON,30V,150MA	01295	1N4152R
CR877	152-0141-02			SEMICON D DEVICE:SILICON,30V,150MA	01295	1N4152R
CR878	152-0141-02			SEMICON D DEVICE:SILICON,30V,150MA	01295	1N4152R
CR879	152-0141-02			SEMICON D DEVICE:SILICON,30V,150MA	01295	1N4152R
CR891	152-0141-02			SEMICON D DEVICE:SILICON,30V,150MA	01295	1N4152R
CR892	152-0141-02			SEMICON D DEVICE:SILICON,30V,150MA	01295	1N4152R
CR893	152-0141-02			SEMICON D DEVICE:SILICON,30V,150MA	01295	1N4152R
CR894	152-0141-02			SEMICON D DEVICE:SILICON,30V,150MA	01295	1N4152R
CR895	152-0141-02			SEMICON D DEVICE:SILICON,30V,150MA	01295	1N4152R
CR896	152-0141-02			SEMICON D DEVICE:SILICON,30V,150MA	01295	1N4152R
CR897	152-0141-02			SEMICON D DEVICE:SILICON,30V,150MA	01295	1N4152R
CR898	152-0141-02			SEMICON D DEVICE:SILICON,30V,150MA	01295	1N4152R
DL1	119-0402-00			DELAY LINE,ELEC:63-66NS,50 OHM	80009	119-0402-00
DL2	119-0402-00			DELAY LINE,ELEC:63-66NS,50 OHM	80009	119-0402-00
J10	131-1003-00			CONN,RCPT,ELEC:CKT BD MT,3 PRONG	80009	131-1003-00
J20	131-1321-00			CONNECTOR,RCPT.:MINIATURE COAX	24931	33JR119-1
J40	131-1320-00			CONNECTOR,PLUG.:MINIATURE COAX	24931	33P110-2
J50	131-1003-00			CONN,RCPT,ELEC:CKT BD MT,3 PRONG	80009	131-1003-00
J70	131-1320-00			CONNECTOR,PLUG.:MINIATURE COAX	24931	33P110-2
J110	131-1171-00			CONNECTOR,RCPT.:BNC,50 OHM	24931	28JR231-1
J120	131-1171-00			CONNECTOR,RCPT.:BNC,50 OHM	24931	28JR231-1
J130	131-0779-00			JACK,TIP:FOR 0.08 INCH DIA TEST POI	98291	016-8010-00-0208
J146	131-0779-00			JACK,TIP:FOR 0.08 INCH DIA TEST POI	98291	016-8010-00-0208
J150	131-0779-00			JACK,TIP:FOR 0.08 INCH DIA TEST POI	98291	016-8010-00-0208
J160	131-1315-00			REPLACED BY:31-1315-01		
J320	131-1003-00			CONN,RCPT,ELEC:CKT BD MT,3 PRONG	80009	131-1003-00
J321	131-1003-00			CONN,RCPT,ELEC:CKT BD MT,3 PRONG	80009	131-1003-00
J570	131-1003-00			CONN,RCPT,ELEC:CKT BD MT,3 PRONG	80009	131-1003-00
J571	131-1003-00			CONN,RCPT,ELEC:CKT BD MT,3 PRONG	80009	131-1003-00

Replaceable Electrical Parts—7S14

Ckt No.	Tektronix Part No.	Serial/Model No.		Name & Description	Mfr Code	Mfr Part Number
		Eff	Dscont			
L71	108-0606-00			COIL,RF:37NH	80009	108-0606-00
L72	108-0561-00			COIL,RF:3.75UH	80009	108-0561-00
L77	108-0691-00			COIL,RF:1.8MH	76493	02279
L79	108-0170-01			COIL,RF:FIXED,36ONH	80009	108-0170-01
L81	108-0606-00			COIL,RF:37NH	80009	108-0606-00
L82	108-0561-00			COIL,RF:3.75UH	80009	108-0561-00
L87	108-0691-00			COIL,RF:1.8MH	76493	02279
L89	108-0170-01			COIL,RF:FIXED,36ONH	80009	108-0170-01
L220	108-0170-01			COIL,RF:FIXED,36ONH	80009	108-0170-01
L320	108-0406-00			COIL,RF:80UH,TOROIDAL	80009	108-0406-00
L420	108-0509-00			COIL,RF:2.45UH	80009	108-0509-00
Q1	151-0301-00			TRANSISTOR:SILICON,PNP	27014	2N2907A
Q1	-----			(HORIZONTAL INTERFACE)		
Q1	151-0254-00			TRANSISTOR:SILICON,NPN	03508	X38L3118
Q1	-----			(READOUT)		
Q1	151-0365-00			TRANSISTOR:SILICON,NPN	03508	X42C182
Q1	-----			(VERTICAL INTERFACE)		
Q2	151-0341-00			TRANSISTOR:SILICON,NPN	07263	S040065
Q2	-----			(HORIZONTAL INTERFACE)		
Q2	151-0364-00			TRANSISTOR:SILICON,PNP	80009	151-0364-00
Q2	-----			(VERTICAL INTERFACE)		
Q2	151-0254-00			TRANSISTOR:SILICON,NPN	03508	X38L3118
Q2	-----			(READOUT)		
Q3	151-1025-00			TRANSISTOR:SILICON,JFE,N-CHANNEL	01295	SFB8129
Q3	-----			(READOUT)		
Q3	151-0364-00			TRANSISTOR:SILICON,PNP	80009	151-0364-00
Q3	-----			(VERTICAL INTERFACE)		
Q3	151-0341-00			TRANSISTOR:SILICON,NPN	07263	S040065
Q3	-----			(HORIZONTAL INTERFACE)		
Q4	151-1025-00	B010100	B060493	TRANSISTOR:SILICON,JFE,N-CHANNEL	01295	SFB8129
Q4	-----			(HORIZONTAL INTERFACE)		
Q4	151-0301-00	B060494		TRANSISTOR:SILICON,PNP	27014	2N2907A
Q4	-----			(HORIZONTAL INTERFACE)		
Q4	151-1025-00			TRANSISTOR:SILICON,JFE,N-CHANNEL	01295	SFB8129
Q4	-----			(READOUT)		
Q5	151-0301-00			TRANSISTOR:SILICON,PNP	27014	2N2907A
Q5	-----			(HORIZONTAL INTERFACE)		
Q5	151-0302-00			TRANSISTOR:SILICON,NPN	07263	S038487
Q5	-----			(READOUT)		
Q6	151-0301-00			TRANSISTOR:SILICON,PNP	27014	2N2907A
Q6	-----			(HORIZONTAL INTERFACE)		
Q6	151-0302-00			TRANSISTOR:SILICON,NPN	07263	S038487
Q6	-----			(READOUT)		
Q7	151-0302-00			TRANSISTOR:SILICON,NPN	07263	S038487
Q10	153-0613-00			SEMICON DVC SE:SILICON,NPN,MATCHED	80009	153-0613-00
Q20	151-0273-00			TRANSISTOR:SILICON,NPN	80009	151-0273-00
Q30	151-0225-00			TRANSISTOR:SILICON,NPN	07263	S39291
Q40	151-1047-00			TRANSISTOR:SILICON,JFE	15818	SU2394
Q122	151-0190-01			TRANSISTOR:SILICON,NPN	80009	151-0190-01
Q123	151-0188-00			TRANSISTOR:SILICON,PNP	04713	SPS6868K
Q124	151-0188-00			TRANSISTOR:SILICON,PNP	04713	SPS6868K
Q139	151-0188-00			TRANSISTOR:SILICON,PNP	04713	SPS6868K
Q140	151-1047-00			TRANSISTOR:SILICON,JFE	15818	SU2394

Ckt No.	Tektronix	Serial/Model No.		Name & Description	Mfr	Mfr Part Number
	Part No.	Eff	Dscont		Code	
Q141	151-0188-00			TRANSISTOR:SILICON,PNP	04713	SPS6868K
Q142	151-0190-00			TRANSISTOR:SILICON,NPN	07263	S032677
Q143	151-0188-00			TRANSISTOR:SILICON,PNP	04713	SPS6868K
Q160	151-0190-01			TRANSISTOR:SILICON,NPN	80009	151-0190-01
Q161	151-0188-00			TRANSISTOR:SILICON,PNP	04713	SPS6868K
Q201	153-0594-00			SEMICON DVC SE:SILICON,NPN,MATCHED PAIR	80009	153-0594-00
Q202	-----			(PART OF Q201)		
Q240	151-1022-00			TRANSISTOR:FET,N-CHAN,SI,F1782,T0-18	17856	FN1234
Q241	151-0192-00			TRANSISTOR:SILICON,NPN,SEL FROM MPS652	04713	SPS8801
Q242	151-0188-00			TRANSISTOR:SILICON,PNP	04713	SPS6868K
Q243	151-0192-00			TRANSISTOR:SILICON,NPN,SEL FROM MPS652	04713	SPS8801
Q244	151-0188-00			TRANSISTOR:SILICON,PNP	04713	SPS6868K
Q245	151-0188-00	B070000		TRANSISTOR:SILICON,PNP	04713	SPS6868K
Q246	151-0190-01	B070000		TRANSISTOR:SILICON,NPN	80009	151-0190-01
Q250	151-0188-00			TRANSISTOR:SILICON,PNP	04713	SPS6868K
Q251	151-0254-00			TRANSISTOR:SILICON,NPN	03508	X38L3118
Q260	151-0190-01			TRANSISTOR:SILICON,NPN	80009	151-0190-01
Q261	151-0190-01			TRANSISTOR:SILICON,NPN	80009	151-0190-01
Q310	151-0190-01			TRANSISTOR:SILICON,NPN	80009	151-0190-01
Q311	151-0188-00			TRANSISTOR:SILICON,PNP	04713	SPS6868K
Q338	151-0341-00			TRANSISTOR:SILICON,NPN	07263	S040065
Q339	151-0341-00			TRANSISTOR:SILICON,NPN	07263	S040065
Q340	151-0192-00			TRANSISTOR:SILICON,NPN,SEL FROM MPS652	04713	SPS8801
Q341	151-1022-00			TRANSISTOR:FET,N-CHAN,SI,F1782,T0-18	17856	FN1234
Q342	151-0325-00			TRANSISTOR:SILICON,PNP,SEL FROM 2N4258	80009	151-0325-00
Q343	151-0325-00			TRANSISTOR:SILICON,PNP,SEL FROM 2N4258	80009	151-0325-00
Q350	151-0254-00			TRANSISTOR:SILICON,NPN	03508	X38L3118
Q351	151-0190-01			TRANSISTOR:SILICON,NPN	80009	151-0190-01
Q352	151-1021-00			TRANSISTOR:SILICON,JFE	17856	FN815
Q353	151-1021-00			TRANSISTOR:SILICON,JFE	17856	FN815
Q354	151-0190-01			TRANSISTOR:SILICON,NPN	80009	151-0190-01
Q355	151-0325-00			TRANSISTOR:SILICON,PNP,SEL FROM 2N4258	80009	151-0325-00
Q356	151-0190-00			TRANSISTOR:SILICON,NPN	07263	S032677
Q357	151-0190-00			TRANSISTOR:SILICON,NPN	07263	S032677
Q358	151-0190-00			TRANSISTOR:SILICON,NPN	07263	S032677
Q359	151-0190-00			TRANSISTOR:SILICON,NPN	07263	S032677
Q360	151-0341-00			TRANSISTOR:SILICON,NPN	07263	S040065
Q361	151-0341-00			TRANSISTOR:SILICON,NPN	07263	S040065
Q362	151-0325-00			TRANSISTOR:SILICON,PNP,SEL FROM 2N4258	80009	151-0325-00
Q380	151-0302-00			TRANSISTOR:SILICON,NPN	07263	S038487
Q420	151-0325-00			TRANSISTOR:SILICON,PNP,SEL FROM 2N4258	80009	151-0325-00
Q421	151-0225-00			TRANSISTOR:SILICON,NPN	07263	S39291
Q430	151-0225-00			TRANSISTOR:SILICON,NPN	07263	S39291
Q440	151-1047-00			TRANSISTOR:SILICON,JFE	15818	SU2394
Q450	151-0190-01			TRANSISTOR:SILICON,NPN	80009	151-0190-01
Q460	151-0190-01			TRANSISTOR:SILICON,NPN	80009	151-0190-01
Q480	151-0302-00			TRANSISTOR:SILICON,NPN	07263	S038487
Q520	151-0325-00			TRANSISTOR:SILICON,PNP,SEL FROM 2N4258	80009	151-0325-00
Q590	151-0224-00			TRANSISTOR:SILICON,NPN	07263	SA24850
R1	317-0201-00	B010100	B029999	RES.,FXD,CMPSN:200 OHM,5%,0.125W	01121	BB2015
R1	317-0202-00	B030000		RES.,FXD,CMPSN:2K OHM,5%,0.125W	01121	BB2025
R2	317-0201-00	B010100	B029999	RES.,FXD,CMPSN:200 OHM,5%,0.125W	01121	BB2015
R2	317-0202-00	B030000		RES.,FXD,CMPSN:2K OHM,5%,0.125W	01121	BB2025

Replaceable Electrical Parts—7S14

Ckt No.	Tektronix Part No.	Serial/Model No. Eff	Dscont	Name & Description	Mfr Code	Mfr Part Number
R4	315-0203-00	B060494		RES.,FXD.CMPSN:20K OHM,5%,0.25W	01121	CB2035
R5	315-0102-00	B060494		RES.,FXD.CMPSN:1K OHM,5%,0.25W	01121	CB1025
R11	317-0202-00			RES.,FXD.CMPSN:2K OHM,5%,0.125W	01121	BB2025
R13	317-0202-00			RES.,FXD.CMPSN:2K OHM,5%,0.125W	01121	BB2025
R14	315-0471-00			RES.,FXD.CMPSN:470 OHM,5%,0.25W	01121	CB4715
R15	317-0151-00			RES.,FXD.CMPSN:150 OHM,5%,0.125W	01121	BB1515
R16	317-0560-00			RES.,FXD.CMPSN:56 OHM,5%,0.125W	01121	BB5605
R17	317-0151-00			RES.,FXD.CMPSN:150 OHM,5%,0.125W	01121	BB1515
R18	317-0560-00			RES.,FXD.CMPSN:56 OHM,5%,0.125W	01121	BB5605
R20	311-1232-00			RES.,VAR.NONWIR:50K OHM,20%,0.50W	32997	3386F-T04-503
R21	315-0303-00			RES.,FXD.CMPSN:30K OHM,5%,0.25W	01121	CB3035
R22	315-0471-00			RES.,FXD.CMPSN:470 OHM,5%,0.25W	01121	CB4715
R30	311-1226-00			RES.,VAR.NONWIR:2.5K OHM,20%,0.50W	32997	3386F-T04-252
R31	315-0153-00	B010100	121617	RES.,FXD.CMPSN:15K OHM,5%,0.25W	01121	CB1535
R31	315-0912-00	B121618		RES.,FXD.CMPSN:9.1K OHM,5%,0.25W	01121	CB9125
R32	315-0102-00			RES.,FXD.CMPSN:1K OHM,5%,0.25W	01121	CB1025
R33	317-0391-00			RES.,FXD.CMPSN:390 OHM,5%,0.125W	01121	BB3915
R34	317-0430-00			RES.,FXD.CMPSN:43 OHM,5%,0.125W	01121	BB4305
R35	307-0098-00			RES.,FXD.FILM:56.4 OHM,0.50%	03888	125R250T56R40D
R40	321-0385-00			RES.,FXD.FILM:100K OHM,1%,0.125W	91637	MFF1816G10002F
R41	321-0385-00			RES.,FXD.FILM:100K OHM,1%,0.125W	91637	MFF1816G10002F
R45	316-0825-00			RES.,FXD.CMPSN:8.2M OHM,10%,0.25W	01121	CB8251
R50	301-0750-00			RES.,FXD.CMPSN:75 OHM,5%,0.50W	01121	EB7505
R60	301-0750-00			RES.,FXD.CMPSN:75 OHM,5%,0.50W	01121	EB7505
R61	317-0201-00			RES.,FXD.CMPSN:200 OHM,5%,0.125W	01121	BB2015
R62	317-0471-00			RES.,FXD.CMPSN:470 OHM,5%,0.125W	01121	BB4715
R70	317-0390-00			RES.,FXD.CMPSN:39 OHM,5%,0.125W	01121	BB3905
R71	317-0910-00			RES.,FXD.CMPSN:91 OHM,5%,0.125W	01121	BB9105
R72	317-0301-00			RES.,FXD.CMPSN:300 OHM,5%,0.125W	01121	BB3015
R73	321-0067-00			RES.,FXD.FILM:48.7 OHM,1%,0.125W	91637	MFF1816G48R70F
R74	317-0331-00	B010100	B090944	RES.,FXD.CMPSN:330 OHM,5%,0.125W	01121	BB3315
R74	317-0181-00	B090945		RES.,FXD.CMPSN:180 OHM,5%,0.125W	01121	BB1815
R74	-----			(NOMINAL VALUE,SELECTED)		
R75	317-0200-00			RES.,FXD.CMPSN:20 OHM,5%,0.125W	01121	BB2005
R76	-----	B010100	B111559	(SELECTED)		
R76	317-0240-00	B111560		RES.,FXD.CMPSN:24 OHM,5%,0.125W	01121	BB2405
R77	317-0202-00			RES.,FXD.CMPSN:2K OHM,5%,0.125W	01121	BB2025
R78	321-0069-00			RES.,FXD.FILM:51.1 OHM,1%,0.125W	91637	MFF1816G51R10F
R79	317-0181-00			RES.,FXD.CMPSN:180 OHM,5%,0.125W	01121	BB1815
R80	317-0202-00	B010100	B090944	RES.,FXD.CMPSN:2K OHM,5%,0.125W	01121	BB2025
R80	317-0821-00	B090945		RES.,FXD.CMPSN:820 OHM,5%,0.125W	01121	BB8215
R81	317-0111-00			RES.,FXD.CMPSN:110 OHM,5%,0.125W	01121	BB1115
R82	317-0301-00			RES.,FXD.CMPSN:300 OHM,5%,0.125W	01121	BB3015
R83	321-0067-00			RES.,FXD.FILM:48.7 OHM,1%,0.125W	91637	MFF1816G48R70F
R84	317-0331-00	B010100	B090944	RES.,FXD.CMPSN:330 OHM,5%,0.125W	01121	BB3315
R84	317-0181-00	B090945		RES.,FXD.CMPSN:180 OHM,5%,0.125W	01121	BB1815
R84	-----			(NOMINAL VALUE,SELECTED)		
R85	317-0200-00			RES.,FXD.CMPSN:20 OHM,5%,0.125W	01121	BB2005
R86	-----	B010100	B111559	(SELECTED)		
R86	317-0240-00	B111560		RES.,FXD.CMPSN:24 OHM,5%,0.125W	01121	BB2405
R87	317-0202-00			RES.,FXD.CMPSN:2K OHM,5%,0.125W	01121	BB2025
R88	321-0069-00			RES.,FXD.FILM:51.1 OHM,1%,0.125W	91637	MFF1816G51R10F
R89	317-0181-00			RES.,FXD.CMPSN:180 OHM,5%,0.125W	01121	BB1815

Ckt No.	Tektronix Part No.	Serial/Model No. Eff	Dscont	Name & Description	Mfr Code	Mfr Part Number
R90	317-0202-00	B010100	B090944	RES.,FXD,CMPSN:2K OHM,5%,0.125W	01121	BB2025
R90	317-0821-00	B090945		RES.,FXD,CMPSN:820 OHM,5%,0.125W	01121	BB8215
R91	317-0201-00			RES.,FXD,CMPSN:200 OHM,5%,0.125W	01121	BB2015
R92	317-0471-00			RES.,FXD,CMPSN:470 OHM,5%,0.125W	01121	BB4715
R100	311-0546-00			RES.,VAR,NONWIR:10K OHM,20%,0.75W	80009	311-0546-00
R101	321-0452-00			RES.,FXD,FILM:499K OHM,1%,0.125W	91637	MFF1816G49902F
R102	321-0414-00			RES.,FXD,FILM:200K OHM,1%,0.125W	91637	MFF1816G20002F
R103	321-0385-00			RES.,FXD,FILM:100K OHM,1%,0.125W	91637	MFF1816G10002F
R104	321-0356-00			RES.,FXD,FILM:49.9K OHM,1%,0.125W	91637	MFF1816G49901F
R105	321-0318-00			RES.,FXD,FILM:20K OHM,1%,0.125W	91637	MFF1816G20001F
R106	321-0289-00			RES.,FXD,FILM:10K OHM,1%,0.125W	91637	MFF1816G10001F
R107	321-0260-00			RES.,FXD,FILM:4.99K OHM,1%,0.125W	91637	MFF1816G49900F
R108	321-0222-00			RES.,FXD,FILM:2K OHM,1%,0.125W	91637	MFF1816G20000F
R109	311-1527-00			RES.,VAR,NONWIR:PNL,50K OHM,0.5W,W/SW	01121	11M338
R110	315-0244-00			RES.,FXD,CMPSN:240K OHM,5%,0.25W	01121	CB2445
R111	315-0183-00			RES.,FXD,CMPSN:18K OHM,5%,0.25W	01121	CB1835
R114	311-1162-00	B010100	B109999	RES.,VAR,NONWIR:2 X 10K OHM,10%,1W	12697	381-CM39691
R114	311-2196-00	B110000		RES.,VAR,WW:10K OHM,5%,1.0W	32997	84N2A-K36-J15 J1
R115	-----			(PART OF R114)		
R119	311-0963-00			RES.,VAR,WW:PNL,5K OHM,0.25W	01121	W-7577A
R121	315-0223-00			RES.,FXD,CMPSN:22K OHM,5%,0.25W	01121	CB2235
R122	315-0103-00			RES.,FXD,CMPSN:10K OHM,5%,0.25W	01121	CB1035
R124	311-1162-00	B010100	B109999	RES.,VAR,NONWIR:2 X 10K OHM,10%,1W	12697	381-CM39691
R124	311-2196-00	B110000		RES.,VAR,WW:10K OHM,5%,1.0W	32997	84N2A-K36-J15 J1
R125	-----			(PART OF R124)		
R126	311-1462-00			RES.,VAR,NONWIR:10K X10K X200K OHM,0.5W	01121	12M437
R127	-----			(PART OF R126)		
R128	-----			(PART OF R126)		
R130	311-1265-00	B010100	B050428	RES.,VAR,NONWIR:2K OHM,10%,0.50W	32997	3329P-L58-202
R130	311-0644-00	B050429		RES.,VAR,NONWIR:20K OHM,10%,0.50W	73138	82-34-1
R131	311-1267-00			RES.,VAR,NONWIR:5K OHM,10%,0.50W	32997	3329P-L58-502
R132	311-1261-00			RES.,VAR,NONWIR:500 OHM,10%,0.50W	32997	3329P-L58-501
R133	321-0306-00	B010100	B050428	RES.,FXD,FILM:15K OHM,1%,0.125W	91637	MFF1816G15001F
R133	321-0402-00	B050429		RES.,FXD,FILM:150K OHM,1%,0.125W	24546	NA55D1503F
R134	321-0285-00	B010100	B050428	RES.,FXD,FILM:9.09K OHM,1%,0.125W	91637	MFF1816G90900F
R134	315-0183-00	B050429		RES.,FXD,CMPSN:18K OHM,5%,0.25W	01121	CB1835
R135	321-0306-00			RES.,FXD,FILM:15K OHM,1%,0.125W	91637	MFF1816G15001F
R136	321-0297-00			RES.,FXD,FILM:12.1K OHM,1%,0.125W	91637	MFF1816G12101F
R137	321-0306-00			RES.,FXD,FILM:15K OHM,1%,0.125W	91637	MFF1816G15001F
R139	311-0328-00			RES.,VAR,NONWIR:1K OHM,20%	01121	W7365
R140	321-0247-00			RES.,FXD,FILM:3.65K OHM,1%,0.125W	91637	MFF1816G36500F
R141	321-0385-00			RES.,FXD,FILM:100K OHM,1%,0.125W	91637	MFF1816G10002F
R142	321-0385-00			RES.,FXD,FILM:100K OHM,1%,0.125W	91637	MFF1816G10002F
R143	321-0347-00			RES.,FXD,FILM:40.2K OHM,1%,0.125W	91637	MFF1816G40201F
R146	311-1324-00			RES.,VAR,WW:10K OHM,5%,2W	02111	534-9572 103J
R147	311-1590-00			RES.,VAR,NONWIR:10K OHM,10%,1W	12697	CM40256
R148	315-0101-00	B010100	B010145	RES.,FXD,CMPSN:100 OHM,5%,0.25W	01121	CB1015
R148	316-0101-00	B010146		RES.,FXD,CMPSN:100 OHM,10%,0.25W	01121	CB1011
R148	-----			(NOMINAL VALUE,SELECTED)		
R149	321-0239-00			RES.,FXD,FILM:3.01K OHM,1%,0.125W	91637	MFF1816G30100F
R150	321-0328-00			RES.,FXD,FILM:25.5K OHM,1%,0.125W	91637	MFF1816G25501F
R151	321-0452-00			RES.,FXD,FILM:499K OHM,1%,0.125W	91637	MFF1816G49902F
R152	321-0414-00			RES.,FXD,FILM:200K OHM,1%,0.125W	91637	MFF1816G20002F
R153	321-0385-00			RES.,FXD,FILM:100K OHM,1%,0.125W	91637	MFF1816G10002F

Replaceable Electrical Parts—7S14

Ckt No.	Tektronix Part No.	Serial/Model No.		Name & Description	Mfr Code	Mfr Part Number
		Eff	Dscont			
R154	321-0356-00			RES.,FXD,FILM:49.9K OHM,1%,0.125W	91637	MFF1816G49901F
R155	321-0318-00			RES.,FXD,FILM:20K OHM,1%,0.125W	91637	MFF1816G20001F
R156	321-0289-00			RES.,FXD,FILM:10K OHM,1%,0.125W	91637	MFF1816G10001F
R157	321-0260-00			RES.,FXD,FILM:4.99K OHM,1%,0.125W	91637	MFF1816G49900F
R158	321-0222-00			RES.,FXD,FILM:2K OHM,1%,0.125W	91637	MFF1816G20000F
R159	311-1527-00			RES.,VAR, NONWIR:PNL,50K OHM,0.5W,W/SW	01121	11M338
R160	315-0304-00			RES.,FXD,CMPSN:300K OHM,5%,0.25W	01121	CB3045
R161	315-0471-00			RES.,FXD,CMPSN:470 OHM,5%,0.25W	01121	CB4715
R162	315-0223-00			RES.,FXD,CMPSN:22K OHM,5%,0.25W	01121	CB2235
R163	315-0104-00			RES.,FXD,CMPSN:100K OHM,5%,0.25W	01121	CB1045
R164	315-0104-00			RES.,FXD,CMPSN:100K OHM,5%,0.25W	01121	CB1045
R165	315-0104-00			RES.,FXD,CMPSN:100K OHM,5%,0.25W	01121	CB1045
R166	315-0104-00			RES.,FXD,CMPSN:100K OHM,5%,0.25W	01121	CB1045
R169	311-0963-00			RES.,VAR,WW:PNL,5K OHM,0.25W	01121	W-7577A
R170	315-0332-00			RES.,FXD,CMPSN:3.3K OHM,5%,0.25W	01121	CB3325
R171	315-0392-00			RES.,FXD,CMPSN:3.9K OHM,5%,0.25W	01121	CB3925
R172	315-0822-00			RES.,FXD,CMPSN:8.2K OHM,5%,0.25W	01121	CB8225
R173	315-0203-00			RES.,FXD,CMPSN:20K OHM,5%,0.25W	01121	CB2035
R174	315-0512-00			RES.,FXD,CMPSN:5.1K OHM,5%,0.25W	01121	CB5125
R175	321-0289-01			RES.,FXD,FILM:10K OHM,0.5%,0.125W	91637	MFF1816G10001D
R176	321-0347-00			RES.,FXD,FILM:40.2K OHM,1%,0.125W	91637	MFF1816G40201F
R177	321-0289-00			RES.,FXD,FILM:10K OHM,1%,0.125W	91637	MFF1816G10001F
R178	311-1518-00			RES.,VAR, NONWIR:10K OHM,20%,1W	01121	11M-324
R180	321-0289-00			RES.,FXD,FILM:10K OHM,1%,0.125W	91637	MFF1816G10001F
R181	321-0385-00			RES.,FXD,FILM:100K OHM,1%,0.125W	91637	MFF1816G10002F
R182	321-0260-00			RES.,FXD,FILM:4.99K OHM,1%,0.125W	91637	MFF1816G49900F
R183	311-1043-00			RES.,VAR, NONWIR:2K OHM,20%,0.50W	01121	W7541A
R190	321-0258-00			RES.,FXD,FILM:4.75K OHM,1%,0.125W	91637	MFF1816G47500F
R191	321-0296-00	B010100	B050428	RES.,FXD,FILM:11.8K OHM,1%,0.125W	91637	MFF1816G11801F
R191	321-0298-00	B050429		RES.,FXD,FILM:12.4K OHM,1%,0.125W	91637	MFF1816G12401F
R196	311-0467-01			RES.,VAR, NONWIR:PNL,100K OHM,0.5W	01121	W-7705-C
R201	315-0470-00			RES.,FXD,CMPSN:47 OHM,5%,0.25W	01121	CB4705
R202	321-0239-00			RES.,FXD,FILM:3.01K OHM,1%,0.125W	91637	MFF1816G30100F
R203	321-0239-00			RES.,FXD,FILM:3.01K OHM,1%,0.125W	91637	MFF1816G30100F
R204	317-0101-00			RES.,FXD,CMPSN:100 OHM,5%,0.125W	01121	BB1015
R207	315-0102-00	B050429		RES.,FXD,CMPSN:1K OHM,5%,0.25W	01121	CB1025
R209	311-1259-00			RES.,VAR, NONWIR:100 OHM,10%,0.50W	32997	3329P-L58-101
R210	315-0102-00			RES.,FXD,CMPSN:1K OHM,5%,0.25W	01121	CB1025
R211	321-0083-00			RES.,FXD,FILM:71.5 OHM,1%,0.125W	91637	MFF1816G71R50F
R212	311-1259-00			RES.,VAR, NONWIR:100 OHM,10%,0.50W	32997	3329P-L58-101
R214	315-0122-00			RES.,FXD,CMPSN:1.2K OHM,5%,0.25W	01121	CB1225
R218	315-0102-00	B050429		RES.,FXD,CMPSN:1K OHM,5%,0.25W	01121	CB1025
R219	315-0202-00			RES.,FXD,CMPSN:2K OHM,5%,0.25W	01121	CB2025
R220	315-0622-00			RES.,FXD,CMPSN:6.2K OHM,5%,0.25W	01121	CB6225
R221	315-0271-00			RES.,FXD,CMPSN:270 OHM,5%,0.25W	01121	CB2715
R222	315-0201-00			RES.,FXD,CMPSN:200 OHM,5%,0.25W	01121	CB2015
R223	315-0392-00			RES.,FXD,CMPSN:3.9K OHM,5%,0.25W	01121	CB3925
R224	315-0751-00	B010100	B090944	RES.,FXD,CMPSN:750 OHM,5%,0.25W	01121	CB7515
R224	315-0331-00	B090945		RES.,FXD,CMPSN:330 OHM,5%,0.25W	01121	CB3315
R225	315-0751-00			RES.,FXD,CMPSN:750 OHM,5%,0.25W	01121	CB7515
R226	315-0100-00	B010100	B069999	RES.,FXD,CMPSN:10 OHM,5%,0.25W	01121	CB1005
R227	315-0133-00			RES.,FXD,CMPSN:13K OHM,5%,0.25W	01121	CB1335
R228	315-0204-00			RES.,FXD,CMPSN:200K OHM,5%,0.25W	01121	CB2045
R229	315-0102-00			RES.,FXD,CMPSN:1K OHM,5%,0.25W	01121	CB1025

Ckt No.	Tektronix Part No.	Serial/Model No.		Name & Description	Mfr Code	Mfr Part Number
		Eff	Dscont			
R230	311-1275-00			RES.,VAR,NONWIR:1M OHM,10%,0.50W	32997	3329P-L58-105
R231	315-0112-00			RES.,FXD,CMPSN:1.1K OHM,5%,0.25W	01121	CB1125
R232	311-1223-00			RES.,VAR,NONWIR:TRMR,250 OHM,0.5W	02111	63M251T602
R233	311-1232-00			RES.,VAR,NONWIR:50K OHM,20%,0.50W	32997	3386F-T04-503
R234	315-0474-00			RES.,FXD,CMPSN:470K OHM,5%,0.25W	01121	CB4745
R235	315-0561-00			RES.,FXD,CMPSN:560 OHM,5%,0.25W	01121	CB5615
R236	315-0512-00			RES.,FXD,CMPSN:5.1K OHM,5%,0.25W	01121	CB5125
R237	315-0104-00			RES.,FXD,CMPSN:100K OHM,5%,0.25W	01121	CB1045
R238	315-0102-00			RES.,FXD,CMPSN:1K OHM,5%,0.25W	01121	CB1025
R239	315-0510-00			RES.,FXD,CMPSN:51 OHM,5%,0.25W	01121	CB5105
R240	315-0102-00			RES.,FXD,CMPSN:1K OHM,5%,0.25W	01121	CB1025
R241	315-0471-00			RES.,FXD,CMPSN:470 OHM,5%,0.25W	01121	CB4715
R242	311-1226-00			RES.,VAR,NONWIR:2.5K OHM,20%,0.50W	32997	3386F-T04-252
R243	315-0393-00			RES.,FXD,CMPSN:39K OHM,5%,0.25W	01121	CB3935
R244	315-0474-00			RES.,FXD,CMPSN:470K OHM,5%,0.25W	01121	CB4745
R245	315-0751-00	B010100	B069999	RES.,FXD,CMPSN:750 OHM,5%,0.25W	01121	CB7515
R245	315-0102-00	B070000		RES.,FXD,CMPSN:1K OHM,5%,0.25W	01121	CB1025
R246	315-0102-00	B010100	B069999	RES.,FXD,CMPSN:1K OHM,5%,0.25W	01121	CB1025
R246	315-0104-00	B070000		RES.,FXD,CMPSN:100K OHM,5%,0.25W	01121	CB1045
R247	315-0102-00	B010100	B069999	RES.,FXD,CMPSN:1K OHM,5%,0.25W	01121	CB1025
R247	315-0104-00	B070000		RES.,FXD,CMPSN:100K OHM,5%,0.25W	01121	CB1045
R248	315-0101-00	B010100	B069999	RES.,FXD,CMPSN:100 OHM,5%,0.25W	01121	CB1015
R248	315-0432-00	B070000		RES.,FXD,CMPSN:4.3K OHM,5%,0.25W	01121	CB4325
R249	315-0102-00	B010100	B069999	RES.,FXD,CMPSN:1K OHM,5%,0.25W	01121	CB1025
R249	315-0821-00	B070000		RES.,FXD,CMPSN:820 OHM,5%,0.25W	01121	CB8215
R250	321-0358-00			RES.,FXD,FILM:52.3K OHM,1%,0.125W	91637	MFF1816G52301F
R251	316-0565-00			RES.,FXD,CMPSN:5.6M OHM,10%,0.25W	01121	CB5651
R252	315-0105-00			RES.,FXD,CMPSN:1M OHM,5%,0.25W	01121	CB1055
R253	321-0223-00			RES.,FXD,FILM:2.05K OHM,1%,0.125W	91637	MFF1816G20500F
R254	315-0332-00			RES.,FXD,CMPSN:3.3K OHM,5%,0.25W	01121	CB3325
R255	315-0510-00			RES.,FXD,CMPSN:51 OHM,5%,0.25W	01121	CB5105
R256	315-0510-00			RES.,FXD,CMPSN:51 OHM,5%,0.25W	01121	CB5105
R257	315-0164-00	B070000		RES.,FXD,CMPSN:160K OHM,5%,0.25W	01121	CB1645
R259	315-0510-00			RES.,FXD,CMPSN:51 OHM,5%,0.25W	01121	CB5105
R260	315-0393-00			RES.,FXD,CMPSN:39K OHM,5%,0.25W	01121	CB3935
R261	315-0472-00			RES.,FXD,CMPSN:4.7K OHM,5%,0.25W	01121	CB4725
R262	315-0303-00			RES.,FXD,CMPSN:30K OHM,5%,0.25W	01121	CB3035
R263	315-0103-00			RES.,FXD,CMPSN:10K OHM,5%,0.25W	01121	CB1035
R264	315-0392-00			RES.,FXD,CMPSN:3.9K OHM,5%,0.25W	01121	CB3925
R265	315-0303-00			RES.,FXD,CMPSN:30K OHM,5%,0.25W	01121	CB3035
R266	315-0751-00	B010100	B069999	RES.,FXD,CMPSN:750 OHM,5%,0.25W	01121	CB7515
R267	315-0751-00	B010100	B069999	RES.,FXD,CMPSN:750 OHM,5%,0.25W	01121	CB7515
R268	315-0751-00	B010100	B069999	RES.,FXD,CMPSN:750 OHM,5%,0.25W	01121	CB7515
R270	315-0102-00			RES.,FXD,CMPSN:1K OHM,5%,0.25W	01121	CB1025
R271	315-0202-00			RES.,FXD,CMPSN:2K OHM,5%,0.25W	01121	CB2025
R272	315-0751-00			RES.,FXD,CMPSN:750 OHM,5%,0.25W	01121	CB7515
R273	315-0751-00			RES.,FXD,CMPSN:750 OHM,5%,0.25W	01121	CB7515
R274	315-0202-00	B010100	B069999	RES.,FXD,CMPSN:2K OHM,5%,0.25W	01121	CB2025
R274	315-0271-00	B070000		RES.,FXD,CMPSN:270 OHM,5%,0.25W	01121	CB2715
R275	321-0920-02			RES.,FXD,FILM:99.6K OHM,0.5%,0.125W	91637	CMF110216D99671D
R276	321-0918-03			RES.,FXD,FILM:109.6K OHM,0.25W,0.125W	91637	MFF1816D10962C
R277	321-0922-02			RES.,FXD,FILM:4.58K OHM,0.5%,0.125W	24546	NC55C4581D
R278	321-0724-03			RES.,FXD,FILM:13.6K OHM,0.25W,0.125W	24546	NC55C1362C
R280	315-0302-00			RES.,FXD,CMPSN:3K OHM,5%,0.25W	01121	CB3025

Replaceable Electrical Parts—7S14

Ckt No.	Tektronix Part No.	Serial/Model No.		Name & Description	Mfr Code	Mfr Part Number
		Eff	Dscont			
R281	315-0153-00			RES.,FXD,CMPSPN:15K OHM,5%,0.25W	01121	CB1535
R282	315-0472-00			RES.,FXD,CMPSPN:4.7K OHM,5%,0.25W	01121	CB4725
R290	315-0122-00			RES.,FXD,CMPSPN:1.2K OHM,5%,0.25W	01121	CB1225
R291	307-0113-00			RES.,FXD,CMPSPN:5.1 OHM,5%,0.25W	01121	CB51G5
R300	315-0154-00			RES.,FXD,CMPSPN:150K OHM,5%,0.25W	01121	CB1545
R303	315-0104-00			RES.,FXD,CMPSPN:100K OHM,5%,0.25W	01121	CB1045
R304	321-0345-00			RES.,FXD,FILM:38.3K OHM,1%,0.125W	91637	MFF1816G38301F
R305	315-0154-00			RES.,FXD,CMPSPN:150K OHM,5%,0.25W	01121	CB1545
R320	315-0510-00			RES.,FXD,CMPSPN:51 OHM,5%,0.25W	01121	CB5105
R321	315-0510-00			RES.,FXD,CMPSPN:51 OHM,5%,0.25W	01121	CB5105
R322	315-0471-00			RES.,FXD,CMPSPN:470 OHM,5%,0.25W	01121	CB4715
R329	316-0101-00	B010146		RES.,FXD,CMPSPN:100 OHM,10%,0.25W	01121	CB1011
R330	311-1232-00			RES.,VAR.NONWIR:50K OHM,20%,0.50W	32997	3386F-T04-503
R331	311-1223-00			RES.,VAR.NONWIR:TRMR,250 OHM,0.5W	02111	63M251T602
R332	315-0393-00			RES.,FXD,CMPSPN:39K OHM,5%,0.25W	01121	CB3935
R333	315-0512-00			RES.,FXD,CMPSPN:5.1K OHM,5%,0.25W	01121	CB5125
R334	315-0474-00			RES.,FXD,CMPSPN:470K OHM,5%,0.25W	01121	CB4745
R335	315-0512-00			RES.,FXD,CMPSPN:5.1K OHM,5%,0.25W	01121	CB5125
R336	315-0393-00			RES.,FXD,CMPSPN:39K OHM,5%,0.25W	01121	CB3935
R337	315-0104-00			RES.,FXD,CMPSPN:100K OHM,5%,0.25W	01121	CB1045
R338	315-0102-00			RES.,FXD,CMPSPN:1K OHM,5%,0.25W	01121	CB1025
R339	321-0235-00			RES.,FXD,FILM:2.74K OHM,1%,0.125W	91637	MFF1816G27400F
R340	315-0101-00			RES.,FXD,CMPSPN:100 OHM,5%,0.25W	01121	CB1015
R341	321-0289-00			RES.,FXD,FILM:10K OHM,1%,0.125W	91637	MFF1816G10001F
R342	315-0153-00			RES.,FXD,CMPSPN:15K OHM,5%,0.25W	01121	CB1535
R343	315-0103-00			RES.,FXD,CMPSPN:10K OHM,5%,0.25W	01121	CB1035
R344	311-1226-00			RES.,VAR.NONWIR:2.5K OHM,20%,0.50W	32997	3386F-T04-252
R345	316-0565-00			RES.,FXD,CMPSPN:5.6M OHM,10%,0.25W	01121	CB5651
R346	321-0231-00			RES.,FXD,FILM:2.49K OHM,1%,0.125W	91637	MFF1816G24900F
R347	315-0223-00			RES.,FXD,CMPSPN:22K OHM,5%,0.25W	01121	CB2235
R348	321-0277-00			RES.,FXD,FILM:7.5K OHM,1%,0.125W	91637	MFF1816G75000F
R349	315-0102-00			RES.,FXD,CMPSPN:1K OHM,5%,0.25W	01121	CB1025
R350	315-0101-00			RES.,FXD,CMPSPN:100 OHM,5%,0.25W	01121	CB1015
R351	315-0303-00			RES.,FXD,CMPSPN:30K OHM,5%,0.25W	01121	CB3035
R352	315-0683-00			RES.,FXD,CMPSPN:68K OHM,5%,0.25W	01121	CB6835
R353	315-0393-00			RES.,FXD,CMPSPN:39K OHM,5%,0.25W	01121	CB3935
R354	315-0510-00			RES.,FXD,CMPSPN:51 OHM,5%,0.25W	01121	CB5105
R355	315-0105-00			RES.,FXD,CMPSPN:1M OHM,5%,0.25W	01121	CB1055
R356	321-0223-00			RES.,FXD,FILM:2.05K OHM,1%,0.125W	91637	MFF1816G20500F
R357	315-0103-00			RES.,FXD,CMPSPN:10K OHM,5%,0.25W	01121	CB1035
R358	315-0104-00			RES.,FXD,CMPSPN:100K OHM,5%,0.25W	01121	CB1045
R359	321-0289-01			RES.,FXD,FILM:10K OHM,0.5%,0.125W	91637	MFF1816G10001D
R360	315-0101-00			RES.,FXD,CMPSPN:100 OHM,5%,0.25W	01121	CB1015
R361	315-0101-00			RES.,FXD,CMPSPN:100 OHM,5%,0.25W	01121	CB1015
R362	315-0393-00			RES.,FXD,CMPSPN:39K OHM,5%,0.25W	01121	CB3935
R363	321-0289-00			RES.,FXD,FILM:10K OHM,1%,0.125W	91637	MFF1816G10001F
R364	321-0235-00			RES.,FXD,FILM:2.74K OHM,1%,0.125W	91637	MFF1816G27400F
R365	315-0510-00			RES.,FXD,CMPSPN:51 OHM,5%,0.25W	01121	CB5105
R366	321-0720-03			RES.,FXD,FILM:60K OHM,0.25%,0.125W	91637	MFF1816D60001C
R367	321-0986-07			RES.,FXD,FILM:25K OHM,0.1%,0.125W	91637	MFF1816C25001B
R368	321-0966-03			RES.,FXD,FILM:40K OHM,0.25%,0.125W	91637	MFF1816D40001C
R369	316-0101-00	B010146		RES.,FXD,CMPSPN:100 OHM,10%,0.25W	01121	CB1011
R370	321-0923-02			RES.,FXD,FILM:25.1K OHM,0.5%,0.125W	24546	NC55C2512D
R371	321-0385-00			RES.,FXD,FILM:100K OHM,1%,0.125W	91637	MFF1816G10002F

Ckt No.	Tektronix Part No.	Serial/Model No.		Name & Description	Mfr Code	Mfr Part Number
		Eff	Dscont			
R372	321-0644-00			RES.,FXD,FILM:100K OHM,0.25%,0.125W	91637	MFF1816C10002C
R373	321-0924-02			RES.,FXD,FILM:40K OHM,0.5%,0.125W	24546	NC55C4002D
R374	321-0318-02			RES.,FXD,FILM:20K OHM,0.5%,0.125W	91637	CMF55116D20001D
R375	321-0924-02			RES.,FXD,FILM:40K OHM,0.5%,0.125W	24546	NC55C4002D
R376	321-0921-02			RES.,FXD,FILM:11.07K OHM,0.5%,0.125W	91637	CMF110216D11071D
R377	321-0919-03			RES.,FXD,FILM:1.107K OHM,0.25%,0.125W	75042	CEAT2-11070C
R378	301-0182-00			RES.,FXD,CMPSN:1.8K OHM,5%,0.5W	01121	EB1825
R380	311-1275-00			RES.,VAR, NONWIR:1M OHM,10%,0.50W	32997	3329P-L58-105
R381	311-1275-00			RES.,VAR, NONWIR:1M OHM,10%,0.50W	32997	3329P-L58-105
R382	315-0472-00			RES.,FXD,CMPSN:4.7K OHM,5%,0.25W	01121	CB4725
R383	315-0101-00			RES.,FXD,CMPSN:100 OHM,5%,0.25W	01121	CB1015
R384	316-0685-00			RES.,FXD,CMPSN:6.8M OHM,10%,0.25W	01121	CB6851
R385	315-0106-00			RES.,FXD,CMPSN:10M OHM,5%,0.25W	01121	CB1065
R386	315-0102-00			RES.,FXD,CMPSN:1K OHM,5%,0.25W	01121	CB1025
R387	315-0102-00			RES.,FXD,CMPSN:1K OHM,5%,0.25W	01121	CB1025
R388	315-0564-00			RES.,FXD,CMPSN:560K OHM,5%,0.25W	01121	CB5645
R389	315-0103-00			RES.,FXD,CMPSN:10K OHM,5%,0.25W	01121	CB1035
R390	315-0682-00			RES.,FXD,CMPSN:6.8K OHM,5%,0.25W	01121	CB6825
R391	315-0103-00			RES.,FXD,CMPSN:10K OHM,5%,0.25W	01121	CB1035
R392	315-0105-00			RES.,FXD,CMPSN:1M OHM,5%,0.25W	01121	CB1055
R393	315-0682-00			RES.,FXD,CMPSN:6.8K OHM,5%,0.25W	01121	CB6825
R394	315-0224-00			RES.,FXD,CMPSN:220K OHM,5%,0.25W	01121	CB2245
R396	315-0472-00	B070000		RES.,FXD,CMPSN:4.7K OHM,5%,0.25W	01121	CB4725
R410	315-0474-00			RES.,FXD,CMPSN:470K OHM,5%,0.25W	01121	CB4745
R411	315-0302-00			RES.,FXD,CMPSN:3K OHM,5%,0.25W	01121	CB3025
R412	321-0171-00			RES.,FXD,FILM:590 OHM,1%,0.125W	91637	MFF1816G590R0F
R413	315-0752-00			RES.,FXD,CMPSN:7.5K OHM,5%,0.25W	01121	CB7525
R420	315-0331-00			RES.,FXD,CMPSN:330 OHM,5%,0.25W	01121	CB3315
R421	315-0511-00			RES.,FXD,CMPSN:510 OHM,5%,0.25W	01121	CB5115
R422	315-0511-00			RES.,FXD,CMPSN:510 OHM,5%,0.25W	01121	CB5115
R423	315-0511-00			RES.,FXD,CMPSN:510 OHM,5%,0.25W	01121	CB5115
R424	315-0912-00			RES.,FXD,CMPSN:9.1K OHM,5%,0.25W	01121	CB9125
R425	315-0513-00			RES.,FXD,CMPSN:51K OHM,5%,0.25W	01121	CB5135
R426	321-0171-00			RES.,FXD,FILM:590 OHM,1%,0.125W	91637	MFF1816G590R0F
R427	315-0511-00			RES.,FXD,CMPSN:510 OHM,5%,0.25W	01121	CB5115
R430	315-0102-00			RES.,FXD,CMPSN:1K OHM,5%,0.25W	01121	CB1025
R431	315-0112-00			RES.,FXD,CMPSN:1.1K OHM,5%,0.25W	01121	CB1125
R432	315-0561-00			RES.,FXD,CMPSN:560 OHM,5%,0.25W	01121	CB5615
R433	321-0247-00			RES.,FXD,FILM:3.65K OHM,1%,0.125W	91637	MFF1816G36500F
R434	315-0106-00			RES.,FXD,CMPSN:10M OHM,5%,0.25W	01121	CB1065
R435	315-0334-00			RES.,FXD,CMPSN:330K OHM,5%,0.25W	01121	CB3345
R436	315-0125-00			RES.,FXD,CMPSN:1.2M OHM,5%,0.25W	01121	CB1255
R437	315-0106-00			RES.,FXD,CMPSN:10M OHM,5%,0.25W	01121	CB1065
R438	315-0100-00			RES.,FXD,CMPSN:10 OHM,5%,0.25W	01121	CB1005
R439	321-0239-00			RES.,FXD,FILM:3.01K OHM,1%,0.125W	91637	MFF1816G30100F
R440	321-0385-00			RES.,FXD,FILM:100K OHM,1%,0.125W	91637	MFF1816G10002F
R441	321-0385-00			RES.,FXD,FILM:100K OHM,1%,0.125W	91637	MFF1816G10002F
R442	321-0347-00			RES.,FXD,FILM:40.2K OHM,1%,0.125W	91637	MFF1816G40201F
R450	321-0289-00			RES.,FXD,FILM:10K OHM,1%,0.125W	91637	MFF1816G10001F
R451	321-0239-00			RES.,FXD,FILM:3.01K OHM,1%,0.125W	91637	MFF1816G30100F
R452	321-0328-00			RES.,FXD,FILM:25.5K OHM,1%,0.125W	91637	MFF1816G25501F
R453	321-0289-00			RES.,FXD,FILM:10K OHM,1%,0.125W	91637	MFF1816G10001F
R454	315-0103-00			RES.,FXD,CMPSN:10K OHM,5%,0.25W	01121	CB1035
R455	321-0358-00			RES.,FXD,FILM:52.3K OHM,1%,0.125W	91637	MFF1816G52301F

Replaceable Electrical Parts—7S14

Ckt No.	Tektronix	Serial/Model No.		Name & Description	Mfr	Mfr Part Number
	Part No.	Eff	Dscont		Code	
R456	315-0241-00			RES.,FXD,CMPSN:240 OHM,5%,0.25W	01121	CB2415
R457	315-0470-00			RES.,FXD,CMPSN:47 OHM,5%,0.25W	01121	CB4705
R458	311-1263-00			RES.,VAR,NONWIR:1K OHM,10%,0.50W	32997	3329P-L58-102
R459	315-0302-00			RES.,FXD,CMPSN:3K OHM,5%,0.25W	01121	CB3025
R460	311-1261-00			RES.,VAR,NONWIR:500 OHM,10%,0.50W	32997	3329P-L58-501
R461	315-0302-00			RES.,FXD,CMPSN:3K OHM,5%,0.25W	01121	CB3025
R462	315-0102-00			RES.,FXD,CMPSN:1K OHM,5%,0.25W	01121	CB1025
R463	315-0102-00			RES.,FXD,CMPSN:1K OHM,5%,0.25W	01121	CB1025
R464	315-0101-00			RES.,FXD,CMPSN:100 OHM,5%,0.25W	01121	CB1015
R465	315-0241-00			RES.,FXD,CMPSN:240 OHM,5%,0.25W	01121	CB2415
R466	315-0511-00			RES.,FXD,CMPSN:510 OHM,5%,0.25W	01121	CB5115
R467	315-0361-00			RES.,FXD,CMPSN:360 OHM,5%,0.25W	01121	CB3615
R468	315-0361-00			RES.,FXD,CMPSN:360 OHM,5%,0.25W	01121	CB3615
R469	315-0100-00			RES.,FXD,CMPSN:10 OHM,5%,0.25W	01121	CB1005
R470	321-0239-00			RES.,FXD,FILM:3.01K OHM,1%,0.125W	91637	MFF1816G30100F
R471	315-0511-00			RES.,FXD,CMPSN:510 OHM,5%,0.25W	01121	CB5115
R472	311-1275-00			RES.,VAR,NONWIR:1M OHM,10%,0.50W	32997	3329P-L58-105
R473	315-0242-00			RES.,FXD,CMPSN:2.4K OHM,5%,0.25W	01121	CB2425
R474	315-0242-00			RES.,FXD,CMPSN:2.4K OHM,5%,0.25W	01121	CB2425
R475	315-0204-00			RES.,FXD,CMPSN:200K OHM,5%,0.25W	01121	CB2045
R476	315-0122-00			RES.,FXD,CMPSN:1.2K OHM,5%,0.25W	01121	CB1225
R477	315-0912-00			RES.,FXD,CMPSN:9.1K OHM,5%,0.25W	01121	CB9125
R478	315-0122-00			RES.,FXD,CMPSN:1.2K OHM,5%,0.25W	01121	CB1225
R480	315-0564-00			RES.,FXD,CMPSN:560K OHM,5%,0.25W	01121	CB5645
R481	315-0275-00			RES.,FXD,CMPSN:2.7M OHM,5%,0.25W	01121	CB2755
R482	315-0151-00			RES.,FXD,CMPSN:150 OHM,5%,0.25W	01121	CB1515
R491	315-0101-00			RES.,FXD,CMPSN:100 OHM,5%,0.25W	01121	CB1015
R492	315-0203-00			RES.,FXD,CMPSN:20K OHM,5%,0.25W	01121	CB2035
R512	315-0242-00			RES.,FXD,CMPSN:2.4K OHM,5%,0.25W	01121	CB2425
R513	315-0471-00			RES.,FXD,CMPSN:470 OHM,5%,0.25W	01121	CB4715
R520	315-0183-00			RES.,FXD,CMPSN:18K OHM,5%,0.25W	01121	CB1835
R521	311-1265-00			RES.,VAR,NONWIR:2K OHM,10%,0.50W	32997	3329P-L58-202
R522	315-0512-00			RES.,FXD,CMPSN:5.1K OHM,5%,0.25W	01121	CB5125
R523	315-0183-00			RES.,FXD,CMPSN:18K OHM,5%,0.25W	01121	CB1835
R524	311-1265-00			RES.,VAR,NONWIR:2K OHM,10%,0.50W	32997	3329P-L58-202
R530	311-1268-00			RES.,VAR,NONWIR:10K OHM,10%,0.50W	32997	3329P-L58-103
R531	315-0106-00			RES.,FXD,CMPSN:10M OHM,5%,0.25W	01121	CB1065
R532	315-0125-00			RES.,FXD,CMPSN:1.2M OHM,5%,0.25W	01121	CB1255
R533	315-0106-00			RES.,FXD,CMPSN:10M OHM,5%,0.25W	01121	CB1065
R534	315-0334-00			RES.,FXD,CMPSN:330K OHM,5%,0.25W	01121	CB3345
R550	315-0102-00			RES.,FXD,CMPSN:1K OHM,5%,0.25W	01121	CB1025
R551	315-0102-00			RES.,FXD,CMPSN:1K OHM,5%,0.25W	01121	CB1025
R552	315-0471-00			RES.,FXD,CMPSN:470 OHM,5%,0.25W	01121	CB4715
R558	315-0221-00			RES.,FXD,CMPSN:220 OHM,5%,0.25W	01121	CB2215
R560	315-0151-00			RES.,FXD,CMPSN:150 OHM,5%,0.25W	01121	CB1515
R561	315-0472-00			RES.,FXD,CMPSN:4.7K OHM,5%,0.25W	01121	CB4725
R570	315-0472-00			RES.,FXD,CMPSN:4.7K OHM,5%,0.25W	01121	CB4725
R571	315-0472-00			RES.,FXD,CMPSN:4.7K OHM,5%,0.25W	01121	CB4725
R590	315-0103-00			RES.,FXD,CMPSN:10K OHM,5%,0.25W	01121	CB1035
R591	315-0105-00			RES.,FXD,CMPSN:1M OHM,5%,0.25W	01121	CB1055
R592	315-0512-00			RES.,FXD,CMPSN:5.1K OHM,5%,0.25W	01121	CB5125
R593	315-0393-00			RES.,FXD,CMPSN:39K OHM,5%,0.25W	01121	CB3935
R594	315-0102-00			RES.,FXD,CMPSN:1K OHM,5%,0.25W	01121	CB1025
R610	321-0335-00			RES.,FXD,FILM:30.1K OHM,1%,0.125W	91637	CMF55116G30101F

Ckt No.	Tektronix		Serial/Model No.		Name & Description	Mfr Code	Mfr Part Number
	Part No.	Eff	Dscont				
R611	321-0318-00				RES.,FXD,FILM:20K OHM,1%,0.125W	91637	MFF1816G20001F
R612	321-0260-00				RES.,FXD,FILM:4.99K OHM,1%,0.125W	91637	MFF1816G49900F
R613	321-0327-00				RES.,FXD,FILM:24.9K OHM,1%,0.125W	91637	MFF1816G24901F
R614	321-0318-00				RES.,FXD,FILM:20K OHM,1%,0.125W	91637	MFF1816G20001F
R615	303-0332-00				RES.,FXD,CMPSPN:3.3K OHM,5%,1W	01121	GB3325
R620	315-0510-00				RES.,FXD,CMPSPN:51 OHM,5%,0.25W	01121	CB5105
R621	315-0510-00				RES.,FXD,CMPSPN:51 OHM,5%,0.25W	01121	CB5105
R651	321-0068-00				RES.,FXD,FILM:49.9 OHM,1%,0.125W	91637	MFF1816G49R90F
R652	321-0068-00				RES.,FXD,FILM:49.9 OHM,1%,0.125W	91637	MFF1816G49R90F
R653	301-0470-00				RES.,FXD,CMPSPN:47 OHM,5%,0.50W	01121	EB4705
R654	321-0068-00				RES.,FXD,FILM:49.9 OHM,1%,0.125W	91637	MFF1816G49R90F
R655	321-0068-00				RES.,FXD,FILM:49.9 OHM,1%,0.125W	91637	MFF1816G49R90F
R656	321-0193-00				RES.,FXD,FILM:1K OHM,1%,0.125W	91637	MFF1816G10000F
R657	321-0193-00				RES.,FXD,FILM:1K OHM,1%,0.125W	91637	MFF1816G10000F
R665	303-0332-00				RES.,FXD,CMPSPN:3.3K OHM,5%,1W	01121	GB3325
R700	315-0103-00				RES.,FXD,CMPSPN:10K OHM,5%,0.25W	01121	CB1035
R701	315-0102-00				RES.,FXD,CMPSPN:1K OHM,5%,0.25W	01121	CB1025
R702	315-0102-00				RES.,FXD,CMPSPN:1K OHM,5%,0.25W	01121	CB1025
R703	321-0231-00				RES.,FXD,FILM:2.49K OHM,1%,0.125W	91637	MFF1816G24900F
R704	315-0182-00				RES.,FXD,CMPSPN:1.8K OHM,5%,0.25W	01121	CB1825
R705	321-0231-00				RES.,FXD,FILM:2.49K OHM,1%,0.125W	91637	MFF1816G24900F
R706	315-0510-00				RES.,FXD,CMPSPN:51 OHM,5%,0.25W	01121	CB5105
R707	315-0103-00				RES.,FXD,CMPSPN:10K OHM,5%,0.25W	01121	CB1035
R708	315-0103-00				RES.,FXD,CMPSPN:10K OHM,5%,0.25W	01121	CB1035
R709	315-0510-00				RES.,FXD,CMPSPN:51 OHM,5%,0.25W	01121	CB5105
R710	315-0103-00				RES.,FXD,CMPSPN:10K OHM,5%,0.25W	01121	CB1035
R711	315-0103-00				RES.,FXD,CMPSPN:10K OHM,5%,0.25W	01121	CB1035
R712	321-0251-00				RES.,FXD,FILM:4.02K OHM,1%,0.125W	91637	MFF1816G40200F
R713	321-0318-00	B010100	B060493		RES.,FXD,FILM:20K OHM,1%,0.125W	91637	MFF1816G20001F
R713	315-0153-00	B060494			RES.,FXD,CMPSPN:15K OHM,5%,0.25W	01121	CB1535
R720	315-0123-00				RES.,FXD,CMPSPN:12K OHM,5%,0.25W	01121	CB1235
R721	321-0251-00				RES.,FXD,FILM:4.02K OHM,1%,0.125W	91637	MFF1816G40200F
R722	321-0374-00	B010100	B060493		RES.,FXD,FILM:76.8K OHM,1%,0.125W	91637	MFF1816G76801F
R730	315-0103-00				RES.,FXD,CMPSPN:10K OHM,5%,0.25W	01121	CB1035
R731	321-0164-00				RES.,FXD,FILM:499 OHM,1%,0.125W	91637	MFF1816G499R0F
R732	321-0314-00				RES.,FXD,FILM:18.2K OHM,1%,0.125W	91637	MFF1816G18201F
R733	321-0289-00				RES.,FXD,FILM:10K OHM,1%,0.125W	91637	MFF1816G10001F
R734	321-0289-00				RES.,FXD,FILM:10K OHM,1%,0.125W	91637	MFF1816G10001F
R735	321-0326-00	B010100	B060493		RES.,FXD,FILM:24.3K OHM,1%,0.125W	91637	MFF1816G24301F
R736	321-0264-00	B010100	B060493		RES.,FXD,FILM:5.49K OHM,1%,0.125W	91637	MFF1816G54900F
R740	315-0393-00				RES.,FXD,CMPSPN:39K OHM,5%,0.25W	01121	CB3935
R812	315-0154-00				RES.,FXD,CMPSPN:150K OHM,5%,0.25W	01121	CB1545
R813	315-0753-00				RES.,FXD,CMPSPN:75K OHM,5%,0.25W	01121	CB7535
R814	315-0154-00				RES.,FXD,CMPSPN:150K OHM,5%,0.25W	01121	CB1545
R815	321-0344-00				RES.,FXD,FILM:37.4K OHM,1%,0.125W	91637	MFF1816G37401F
R816	315-0753-00				RES.,FXD,CMPSPN:75K OHM,5%,0.25W	01121	CB7535
R817	315-0154-00				RES.,FXD,CMPSPN:150K OHM,5%,0.25W	01121	CB1545
R821	315-0753-00				RES.,FXD,CMPSPN:75K OHM,5%,0.25W	01121	CB7535
R822	321-0344-00				RES.,FXD,FILM:37.4K OHM,1%,0.125W	91637	MFF1816G37401F
R823	315-0154-00				RES.,FXD,CMPSPN:150K OHM,5%,0.25W	01121	CB1545
R824	315-0753-00				RES.,FXD,CMPSPN:75K OHM,5%,0.25W	01121	CB7535
R825	315-0154-00				RES.,FXD,CMPSPN:150K OHM,5%,0.25W	01121	CB1545
R841	321-0296-00				RES.,FXD,FILM:11.8K OHM,1%,0.125W	91637	MFF1816G11801F
R842	321-0296-00				RES.,FXD,FILM:11.8K OHM,1%,0.125W	91637	MFF1816G11801F

Replaceable Electrical Parts—7S14

Ckt No.	Tektronix	Serial/Model No.		Name & Description	Mfr	Mfr Part Number
	Part No.	Eff	Dscont		Code	
R843	315-0753-00			RES.,FXD,CMPSN:75K OHM,5%,0.25W	01121	CB7535
R844	315-0753-00			RES.,FXD,CMPSN:75K OHM,5%,0.25W	01121	CB7535
R845	315-0154-00			RES.,FXD,CMPSN:150K OHM,5%,0.25W	01121	CB1545
R846	315-0154-00			RES.,FXD,CMPSN:150K OHM,5%,0.25W	01121	CB1545
R847	315-0154-00			RES.,FXD,CMPSN:150K OHM,5%,0.25W	01121	CB1545
R848	315-0154-00			RES.,FXD,CMPSN:150K OHM,5%,0.25W	01121	CB1545
R849	315-0753-00			RES.,FXD,CMPSN:75K OHM,5%,0.25W	01121	CB7535
R850	315-0433-00			RES.,FXD,CMPSN:43K OHM,5%,0.25W	01121	CB4335
R851	315-0753-00			RES.,FXD,CMPSN:75K OHM,5%,0.25W	01121	CB7535
R852	315-0433-00			RES.,FXD,CMPSN:43K OHM,5%,0.25W	01121	CB4335
R853	321-0356-00			RES.,FXD,FILM:49.9K OHM,1%,0.125W	91637	MFF1816G49901F
R854	315-0154-00			RES.,FXD,CMPSN:150K OHM,5%,0.25W	01121	CB1545
R855	315-0513-00			RES.,FXD,CMPSN:51K OHM,5%,0.25W	01121	CB5135
R856	321-0356-00			RES.,FXD,FILM:49.9K OHM,1%,0.125W	91637	MFF1816G49901F
R857	315-0513-00			RES.,FXD,CMPSN:51K OHM,5%,0.25W	01121	CB5135
R858	315-0154-00			RES.,FXD,CMPSN:150K OHM,5%,0.25W	01121	CB1545
R859	321-0344-00			RES.,FXD,FILM:37.4K OHM,1%,0.125W	91637	MFF1816G37401F
R860	315-0753-00			RES.,FXD,CMPSN:75K OHM,5%,0.25W	01121	CB7535
R861	321-0344-00			RES.,FXD,FILM:37.4K OHM,1%,0.125W	91637	MFF1816G37401F
R862	315-0753-00			RES.,FXD,CMPSN:75K OHM,5%,0.25W	01121	CB7535
R863	315-0104-00			RES.,FXD,CMPSN:100K OHM,5%,0.25W	01121	CB1045
R864	315-0104-00			RES.,FXD,CMPSN:100K OHM,5%,0.25W	01121	CB1045
R871	315-0753-00			RES.,FXD,CMPSN:75K OHM,5%,0.25W	01121	CB7535
R872	315-0154-00			RES.,FXD,CMPSN:150K OHM,5%,0.25W	01121	CB1545
R873	315-0753-00			RES.,FXD,CMPSN:75K OHM,5%,0.25W	01121	CB7535
R874	321-0344-00			RES.,FXD,FILM:37.4K OHM,1%,0.125W	91637	MFF1816G37401F
R875	315-0154-00			RES.,FXD,CMPSN:150K OHM,5%,0.25W	01121	CB1545
R876	315-0154-00			RES.,FXD,CMPSN:150K OHM,5%,0.25W	01121	CB1545
R877	315-0753-00			RES.,FXD,CMPSN:75K OHM,5%,0.25W	01121	CB7535
R878	315-0303-00			RES.,FXD,CMPSN:30K OHM,5%,0.25W	01121	CB3035
R879	315-0303-00			RES.,FXD,CMPSN:30K OHM,5%,0.25W	01121	CB3035
R880	321-0356-00			RES.,FXD,FILM:49.9K OHM,1%,0.125W	91637	MFF1816G49901F
R881	315-0753-00			RES.,FXD,CMPSN:75K OHM,5%,0.25W	01121	CB7535
R882	315-0303-00			RES.,FXD,CMPSN:30K OHM,5%,0.25W	01121	CB3035
R883	315-0154-00			RES.,FXD,CMPSN:150K OHM,5%,0.25W	01121	CB1545
R884	321-0356-00			RES.,FXD,FILM:49.9K OHM,1%,0.125W	91637	MFF1816G49901F
R885	315-0154-00			RES.,FXD,CMPSN:150K OHM,5%,0.25W	01121	CB1545
R886	321-0344-00			RES.,FXD,FILM:37.4K OHM,1%,0.125W	91637	MFF1816G37401F
R891	315-0154-00			RES.,FXD,CMPSN:150K OHM,5%,0.25W	01121	CB1545
R892	315-0753-00			RES.,FXD,CMPSN:75K OHM,5%,0.25W	01121	CB7535
R893	321-0344-00			RES.,FXD,FILM:37.4K OHM,1%,0.125W	91637	MFF1816G37401F
R894	315-0154-00			RES.,FXD,CMPSN:150K OHM,5%,0.25W	01121	CB1545
R895	315-0154-00			RES.,FXD,CMPSN:150K OHM,5%,0.25W	01121	CB1545
R896	315-0753-00			RES.,FXD,CMPSN:75K OHM,5%,0.25W	01121	CB7535
R897	315-0753-00			RES.,FXD,CMPSN:75K OHM,5%,0.25W	01121	CB7535
R898	315-0753-00			RES.,FXD,CMPSN:75K OHM,5%,0.25W	01121	CB7535
S110	262-0963-00			SWITCH,WIRED:VOLTS/DIV	80009	262-0963-00
S120	262-0963-00			SWITCH,WIRED:VOLTS/DIV	80009	262-0963-00
S130	260-1500-00	B010100	B070829	SWITCH,PUSH:1 BUTTON,PB400.2P,P-PUSH	82104	A1348PB4020001
S130	260-1500-01	B070830		SWITCH,PUSH:1 BUTTON,PB400.2P,P-PUSH	80009	260-1500-01
S210	260-1504-00	B010100	B070829	SWITCH,PUSH:1 BUTTON,PB400.6P,PUSH-PUSH	82104	1351PB4060001
S210	260-1504-01	B070830		SWITCH,PUSH:1 BUTTON,PB400.6P,PUSH-PUSH	80009	260-1504-01

Ckt No.	Tektronix Part No.	Serial/Model No. Eff	Dscont	Name & Description	Mfr Code	Mfr Part Number
S240	263-1032-00			SW CAM ACTR AS:DELAYING SWEEP SEC/DIV	80009	263-1032-00
S260	-----			(SEE S240)		
S300	260-1501-00	B010100	B070829	SWITCH,PUSH:5 BUTTON,PB400,2P,P-PUSH	82104	B1149PB401005
S300	260-1501-01	B070830		SWITCH,PUSH:5 BUTTON,PB400,2P,P-PUSH	80009	260-1501-01
S302	-----			(SEE S300)		
S304	-----			(SEE S300)		
S306	-----			(SEE S300)		
S308	-----			(SEE S300)		
S310	260-1505-00	B010100	B070829	SWITCH,PUSH:6 BTN,PB400,2P,P-P & IN-LK	82104	A1148PB4021006
S310	260-1505-01	B070830		SWITCH,PUSH:6BTN,2P,P-P & INTERLOCK	80009	260-1505-01
S312	-----			(SEE S310)		
S320	260-1502-00	B010100	B070829	SWITCH,PUSH:2 BUTTON,PB400,2P,P-PUSH	82104	1349PB4021002
S320	260-1502-01	B070830		SWITCH,PUSH:2 BUTTON,PB400,2P P-PUSH	80009	260-1502-01
S410	-----			(SEE S310)		
S412	-----			(SEE S310)		
S420	-----			(SEE S320)		
S480	260-1503-00	B010100	B080964	SWITCH,PUSH:1 BUTTON,PB400,2POLE,MOM	82104	1350PB4020001
S480	260-1503-01	B080965	B121624	SWITCH,PUSH:1 BTN,2 POLE,START	80009	260-1503-01
S480	260-1503-02	B121625		SWITCH,PUSH:1 BUTTON,2 POLE,START		
S510	-----			(SEE S310)		
S512	-----			(SEE S310)		
T10	120-0860-00			XFMR,TOROID:2 WINDINGS	80009	120-0860-00
T11	120-0501-00			XFMR,TOROID:7 TURNS BIFILAR	80009	120-0501-00
T12	120-0318-00			XFMR,TOROID:6 TURNS BIFILAR	80009	120-0318-00
U1	156-0067-00			MICROCIRCUIT,LI:OPERATIONAL AMPLIFIER	01295	MICROA741CP
U1	-----			(VERTICAL INTERFACE)		
U1	156-0057-02			MICROCIRCUIT,DI:QUAD 2-INP NAND GATE,SCRN	01295	SN7401(NP3 OR JP
U1	-----			(HORIZONTAL INTERFACE)		
U2	156-0067-00			MICROCIRCUIT,LI:OPERATIONAL AMPLIFIER	01295	MICROA741CP
U2	-----			(VERTICAL INTERFACE)		
U2	156-0158-00			MICROCIRCUIT,LI:DUAL OPERATIONAL AMPLIFIER	18324	MC1458N
U2	-----			(HORIZONTAL INTERFACE)		
U3	156-0067-00			MICROCIRCUIT,LI:OPERATIONAL AMPLIFIER	01295	MICROA741CP
U4	156-0158-00			MICROCIRCUIT,LI:DUAL OPERATIONAL AMPLIFIER	18324	MC1458N
U5	156-0158-00			MICROCIRCUIT,LI:DUAL OPERATIONAL AMPLIFIER	18324	MC1458N
U10	156-0200-00			MICROCIRCUIT,LI:OPERATIONAL AMPLIFIER	04713	MC1456P1
U140	156-0158-00			MICROCIRCUIT,LI:DUAL OPERATIONAL AMPLIFIER	18324	MC1458N
U145	156-0158-00			MICROCIRCUIT,LI:DUAL OPERATIONAL AMPLIFIER	18324	MC1458N
U150	156-0158-00			MICROCIRCUIT,LI:DUAL OPERATIONAL AMPLIFIER	18324	MC1458N
U155	156-0158-00			MICROCIRCUIT,LI:DUAL OPERATIONAL AMPLIFIER	18324	MC1458N
U180	156-0158-00			MICROCIRCUIT,LI:DUAL OPERATIONAL AMPLIFIER	18324	MC1458N
U220	156-0353-00			MICROCIRCUIT,DI:TPL 2-INPUT EXCL OR GATE	80009	156-0353-00
U230	156-0067-00			MICROCIRCUIT,LI:OPERATIONAL AMPLIFIER	01295	MICROA741CP
U240	156-0205-00	B010100	B069999	MICROCIRCUIT,DI:QUAD 2-INPUT NOR GATE	04713	MC10102 (P OR L)
U250	156-0067-00			MICROCIRCUIT,LI:OPERATIONAL AMPLIFIER	01295	MICROA741CP
U260	156-0205-00	B010100	B069999	MICROCIRCUIT,DI:QUAD 2-INPUT NOR GATE	04713	MC10102 (P OR L)
U270	155-0109-00	B070000	B070599	MICROCIRCUIT,LI:MONOLITHIC,TRIG	80009	155-0109-00
U270	155-0109-01	B070600		MICROCIRCUIT,LI:MONOLITHIC TRIGGER	80009	155-0109-01
U280	155-0042-02	B010100	B052089	MICROCIRCUIT,LI:MILLER INTEGRATOR	80009	155-0042-02
U280	155-0028-00	B050290		MICROCIRCUIT,LI:ML,MILLER INTEGRATOR	80009	155-0028-00
U330	156-0067-00			MICROCIRCUIT,LI:OPERATIONAL AMPLIFIER	01295	MICROA741CP
U335	156-0067-00			MICROCIRCUIT,LI:OPERATIONAL AMPLIFIER	01295	MICROA741CP
U350	156-0067-00			MICROCIRCUIT,LI:OPERATIONAL AMPLIFIER	01295	MICROA741CP

Replaceable Electrical Parts—7S14

Ckt No.	Tektronix Part No.	Serial/Model No.		Name & Description	Mfr Code	Mfr Part Number
		Eff	Dscont			
U360	156-0067-00			MICROCIRCUIT,LI:OPERATIONAL AMPLIFIER	01295	MICROA741CP
U390	155-0056-00			MICROCIRCUIT,DI:SWEEP CONTROL	80009	155-0056-00
U430	156-0200-00			MICROCIRCUIT,LI:OPERATIONAL AMPLIFIER	04713	MC1456P1
U440	156-0158-00			MICROCIRCUIT,LI:DUAL OPERATIONAL AMPLIFIER	18324	MC1458N
U450	156-0067-00			MICROCIRCUIT,LI:OPERATIONAL AMPLIFIER	01295	MICROA741CP
U455	156-0308-00			MICROCIRCUIT,DI:QUAD DIFF LINE RECEIVER	04713	SC22689P115
U470	156-0308-00			MICROCIRCUIT,DI:QUAD DIFF LINE RECEIVER	04713	SC22689P115
U490	156-0067-00			MICROCIRCUIT,LI:OPERATIONAL AMPLIFIER	01295	MICROA741CP
U530	156-0200-00			MICROCIRCUIT,LI:OPERATIONAL AMPLIFIER	04713	MC1456P1
VR610	152-0279-00			SEMICONV DEVICE:ZENER,0.4W,5.1V,5%	04713	SZG35010RL
VR613	152-0279-00			SEMICONV DEVICE:ZENER,0.4W,5.1V,5%	04713	SZG35010RL

DIAGRAMS AND CIRCUIT BOARD ILLUSTRATIONS

Symbols and Reference Designators

Electrical components shown on the diagrams are in the following units unless noted otherwise:

- Capacitors = Values one or greater are in picofarads (pF).
Values less than one are in microfarads (μF).
- Resistors = Ohms (Ω).

Graphic symbols and class designation letters are based on ANSI Standard Y32.2-1975.

Logic symbology is based on ANSI Y32.14-1973 in terms of positive logic. Logic symbols depict the logic function performed and may differ from the manufacturer's data.

The overline on a signal name indicates that the signal performs its intended function when it goes to the low state.

Abbreviations are based on ANSI Y1.1-1972.

Other ANSI standards that are used in the preparation of diagrams by Tektronix, Inc. are:

- Y14.15, 1966 Drafting Practices.
- Y14.2, 1973 Line Conventions and Lettering.
- Y10.5, 1968 Letter Symbols for Quantities Used in Electrical Science and Electrical Engineering.

The following prefix letters are used as reference designators to identify components or assemblies on the diagrams.

A	Assembly, separable or repairable (circuit board, etc)	H	Heat dissipating device (heat sink, heat radiator, etc)	S	Switch or contactor
AT	Attenuator, fixed or variable	HR	Heater	T	Transformer
B	Motor	HY	Hybrid circuit	TC	Thermocouple
BT	Battery	J	Connector, stationary portion	TP	Test point
C	Capacitor, fixed or variable	K	Relay	U	Assembly, inseparable or non-repairable (integrated circuit, etc.)
CB	Circuit breaker	L	Inductor, fixed or variable	V	Electron tube
CR	Diode, signal or rectifier	M	Meter	VR	Voltage regulator (zener diode, etc.)
DL	Delay line	P	Connector, movable portion	W	Wirestrap or cable
DS	Indicating device (lamp)	Q	Transistor or silicon-controlled rectifier	Y	Crystal
E	Spark Gap, Ferrite bead	R	Resistor, fixed or variable	Z	Phase shifter
F	Fuse	RT	Thermistor		
FL	Filter				

The following special symbols may appear on the diagrams:

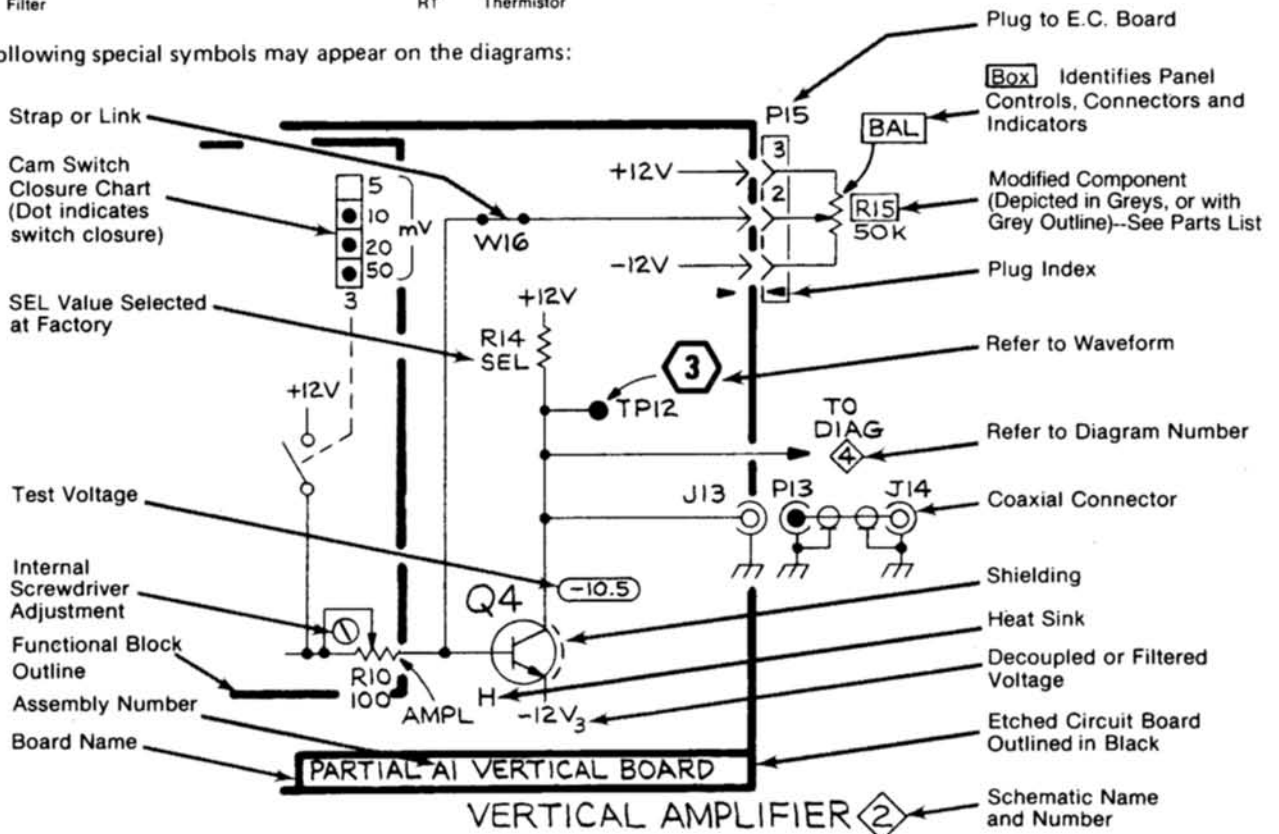

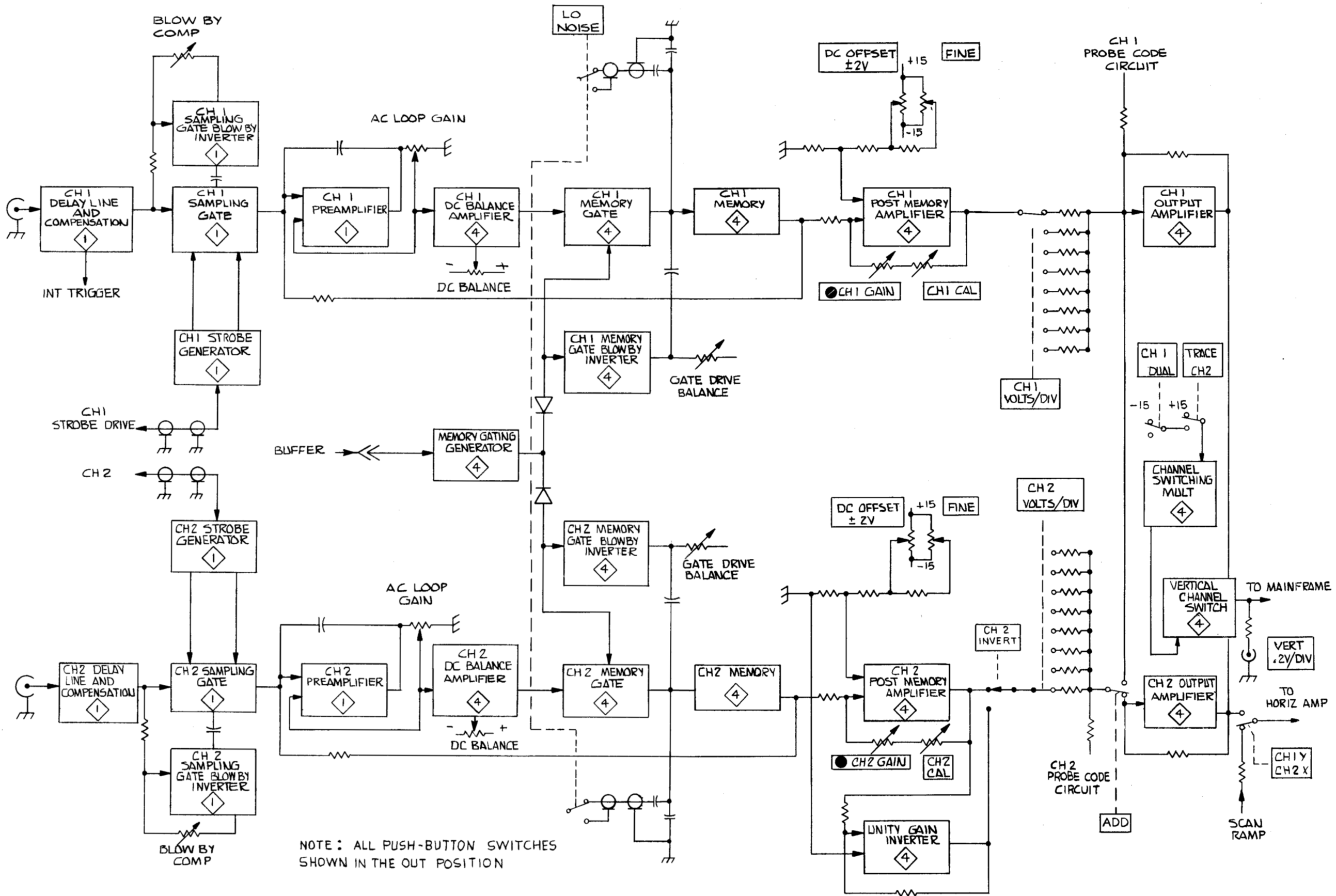

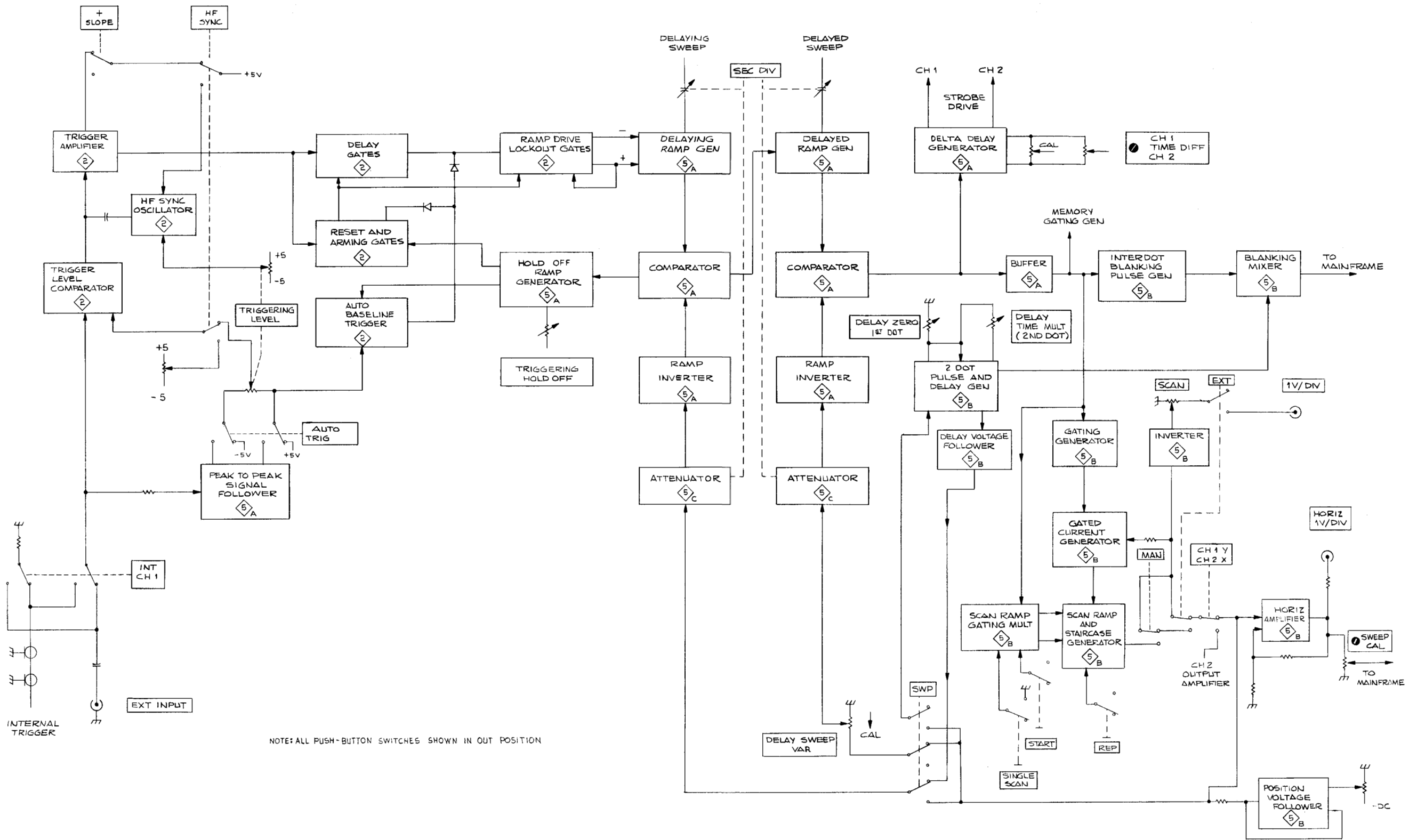

NOTE: ALL PUSH-BUTTON SWITCHES SHOWN IN OUT POSITION

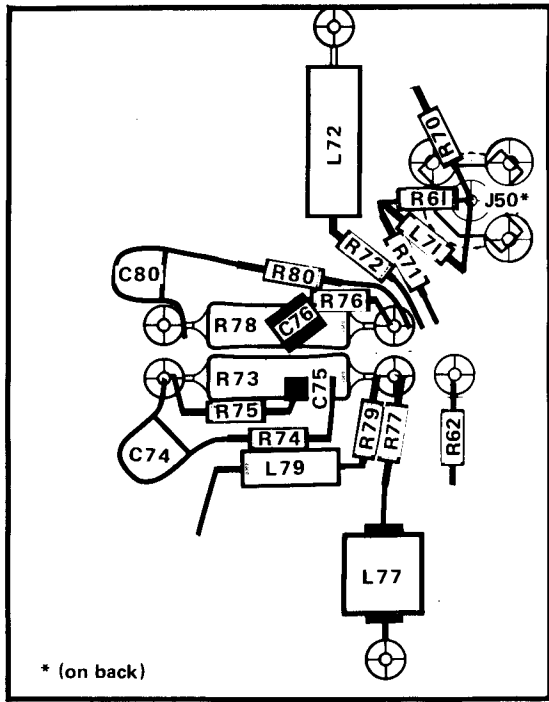

Channel 1 Compensation Board 1

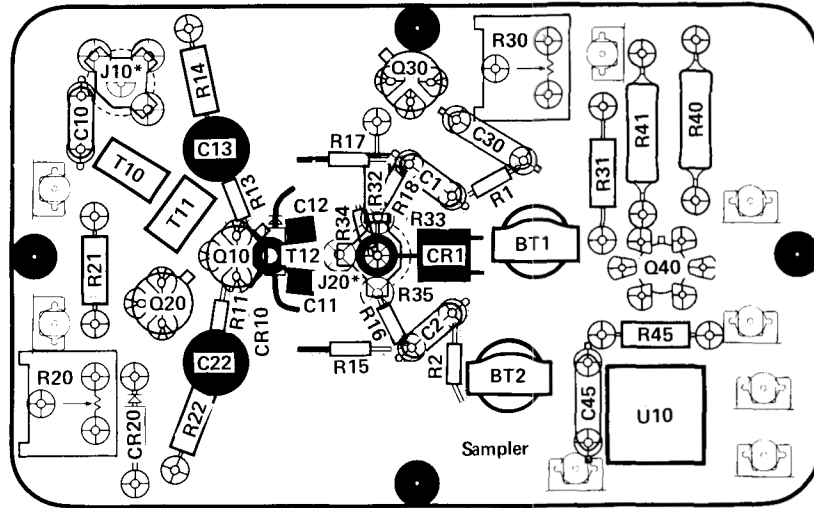

Channel 1 Sampler Board 1

REV APR 1982

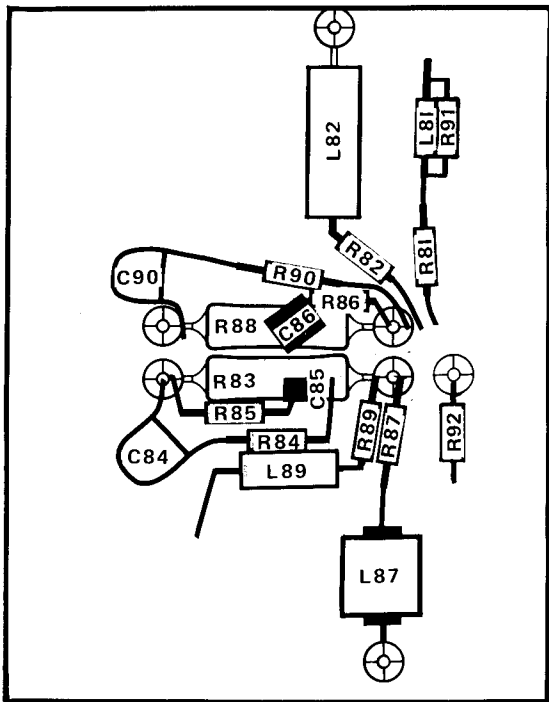

Channel 2 Compensation Board 1

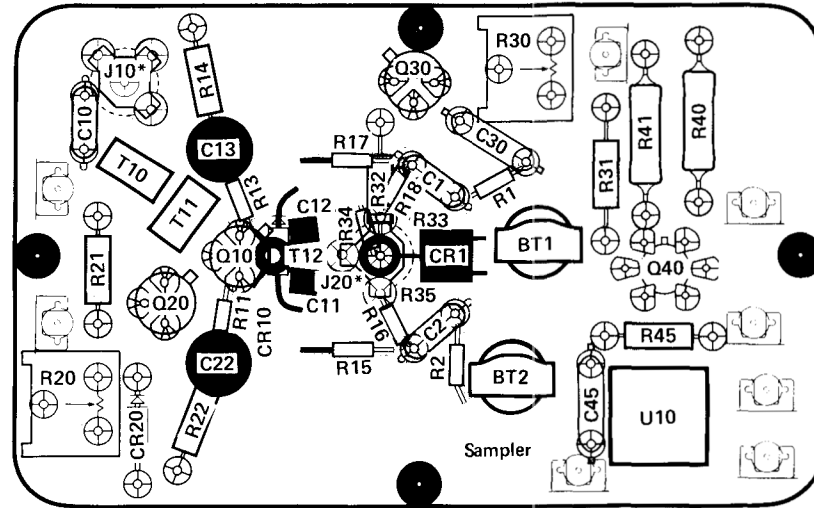

Channel 2 Sampler Board 1

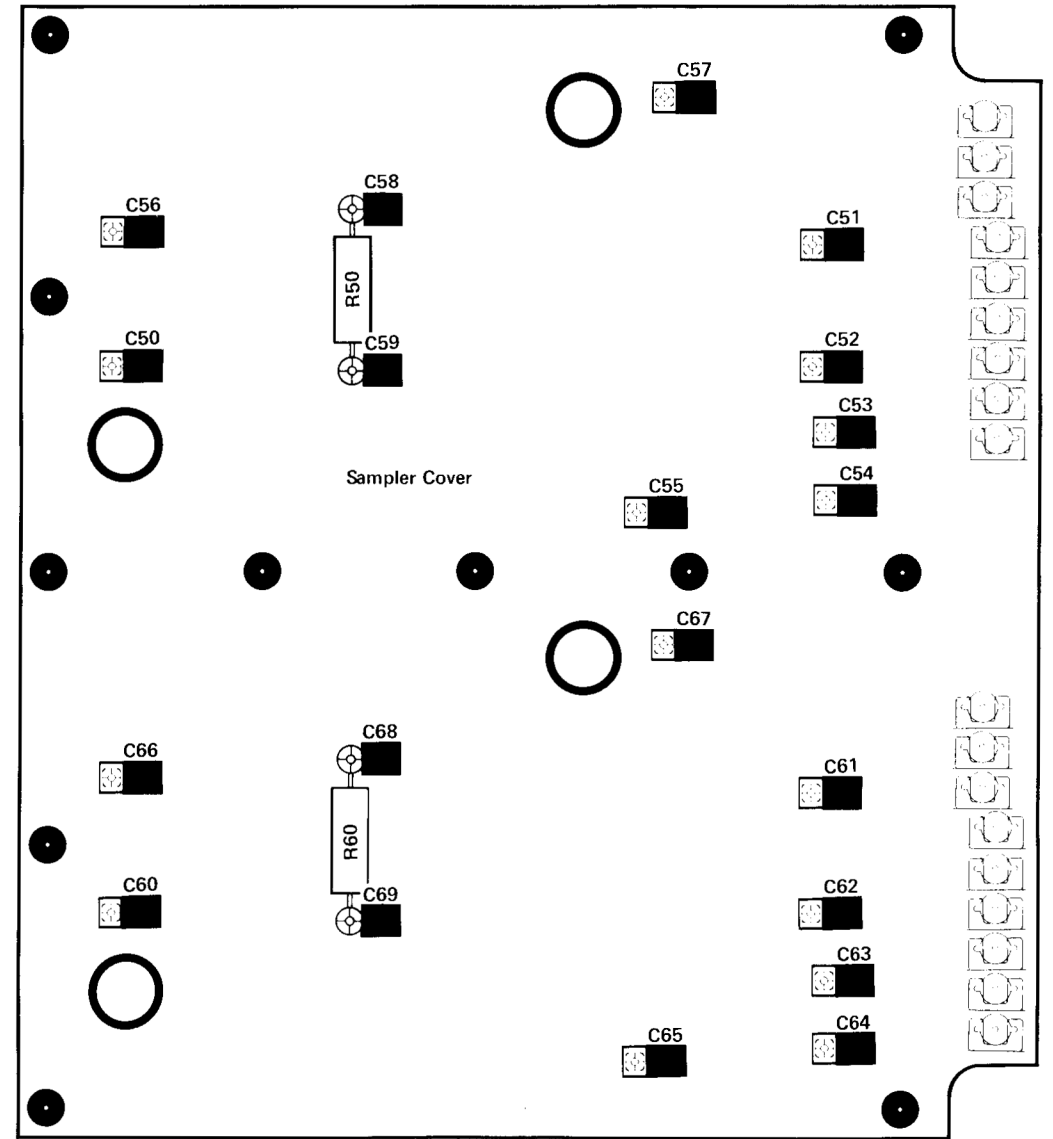

Sampler Cover (rear view) 1

7S14

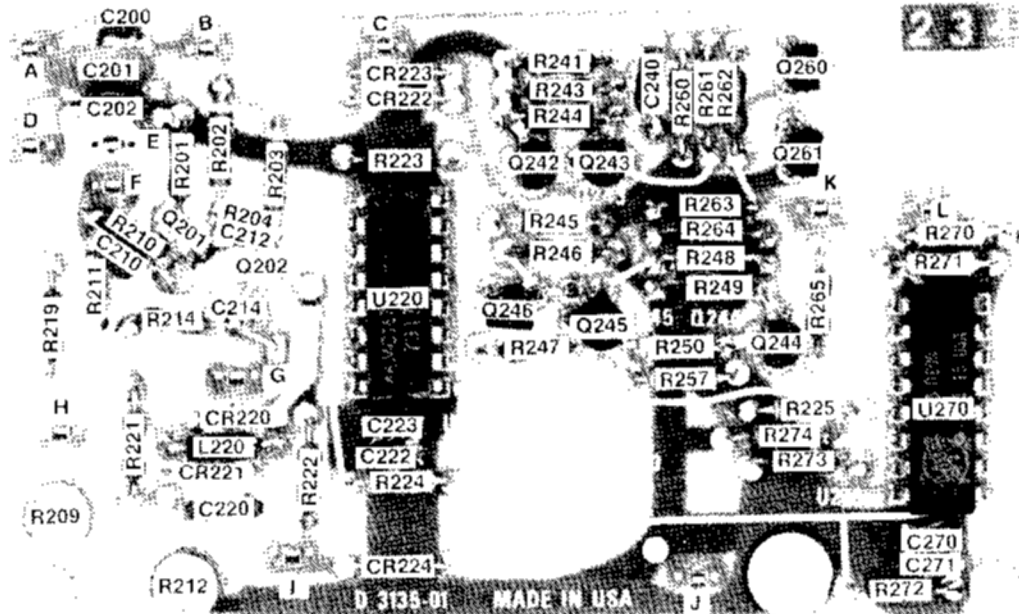

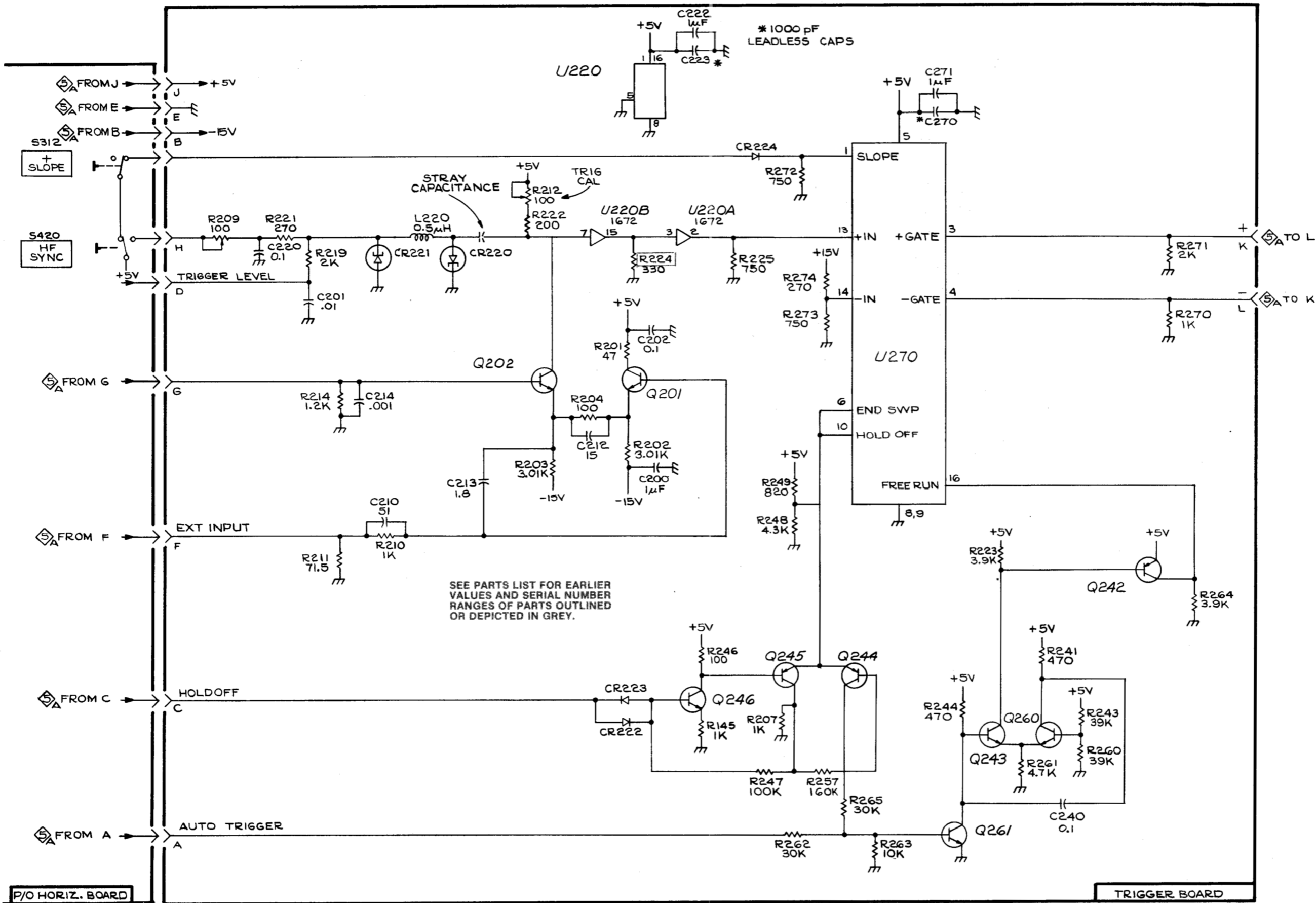

* 1000 pF LEADLESS CAPS

SEE PARTS LIST FOR EARLIER VALUES AND SERIAL NUMBER RANGES OF PARTS OUTLINED OR DEPICTED IN GREY.

P/O HORIZ. BOARD

TRIGGER BOARD

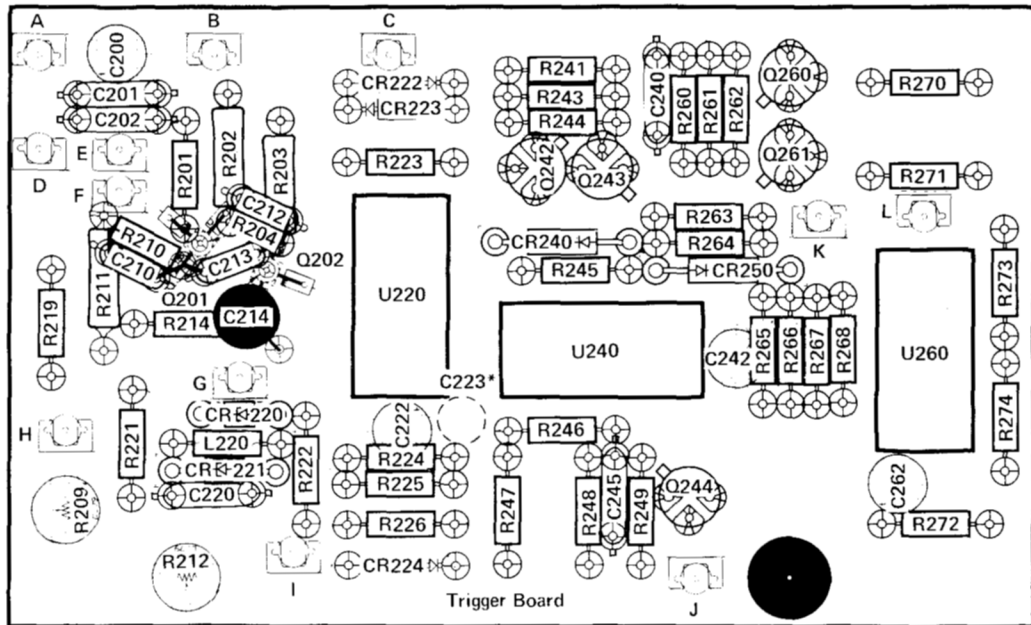

Trigger Board **2** (SN B069999 & Below)

*(on back)

1

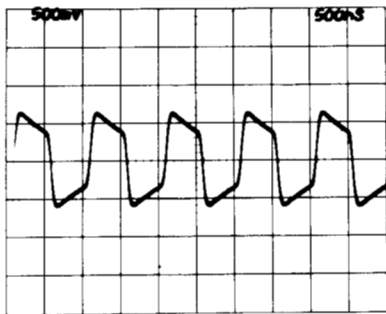

4

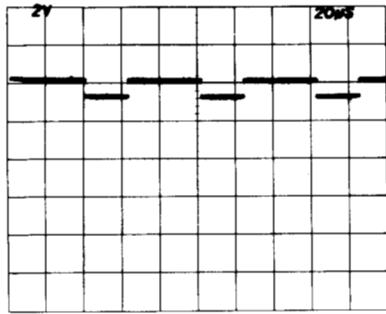

2

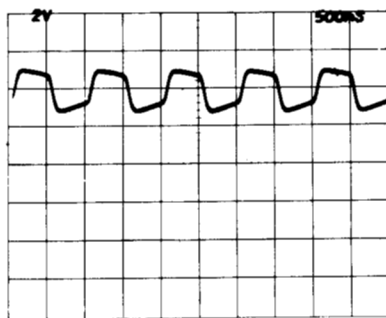

5

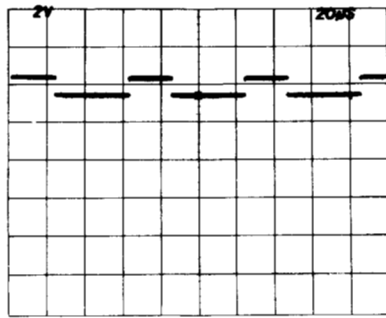

3

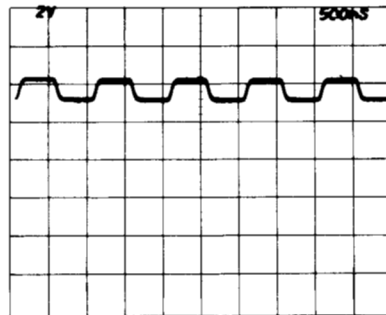

6

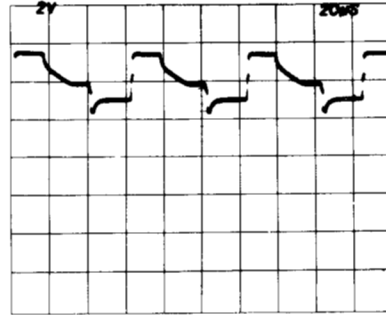

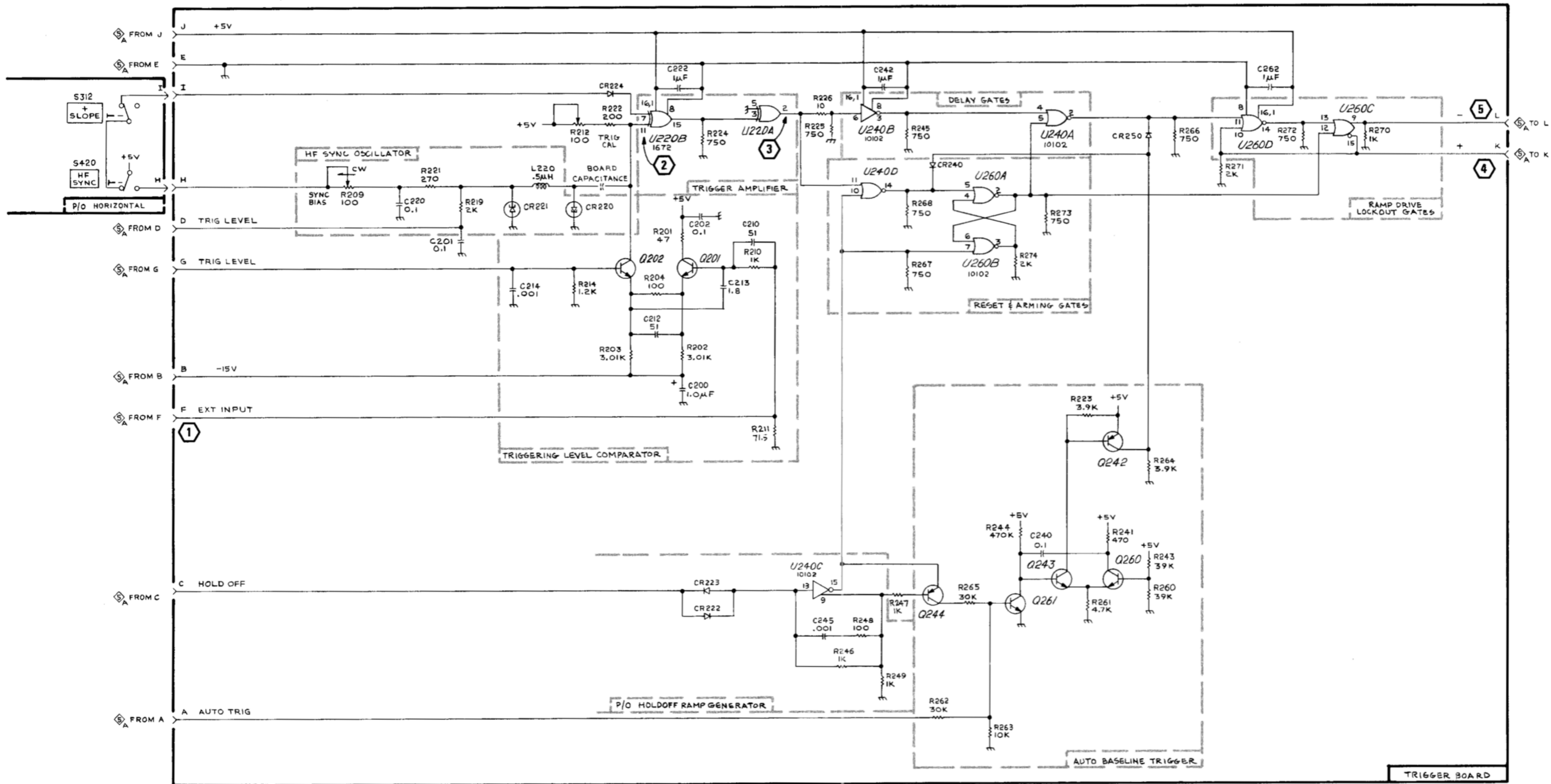

NOTE: PUSH BUTTON SWITCHES SHOWN IN OUT POSITION

Vertical Mode Switch

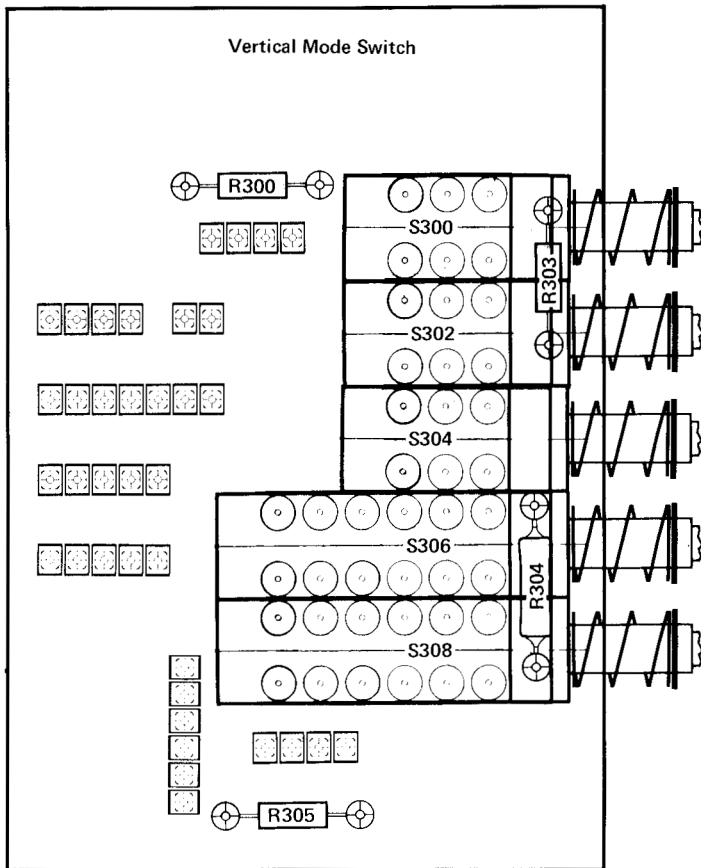

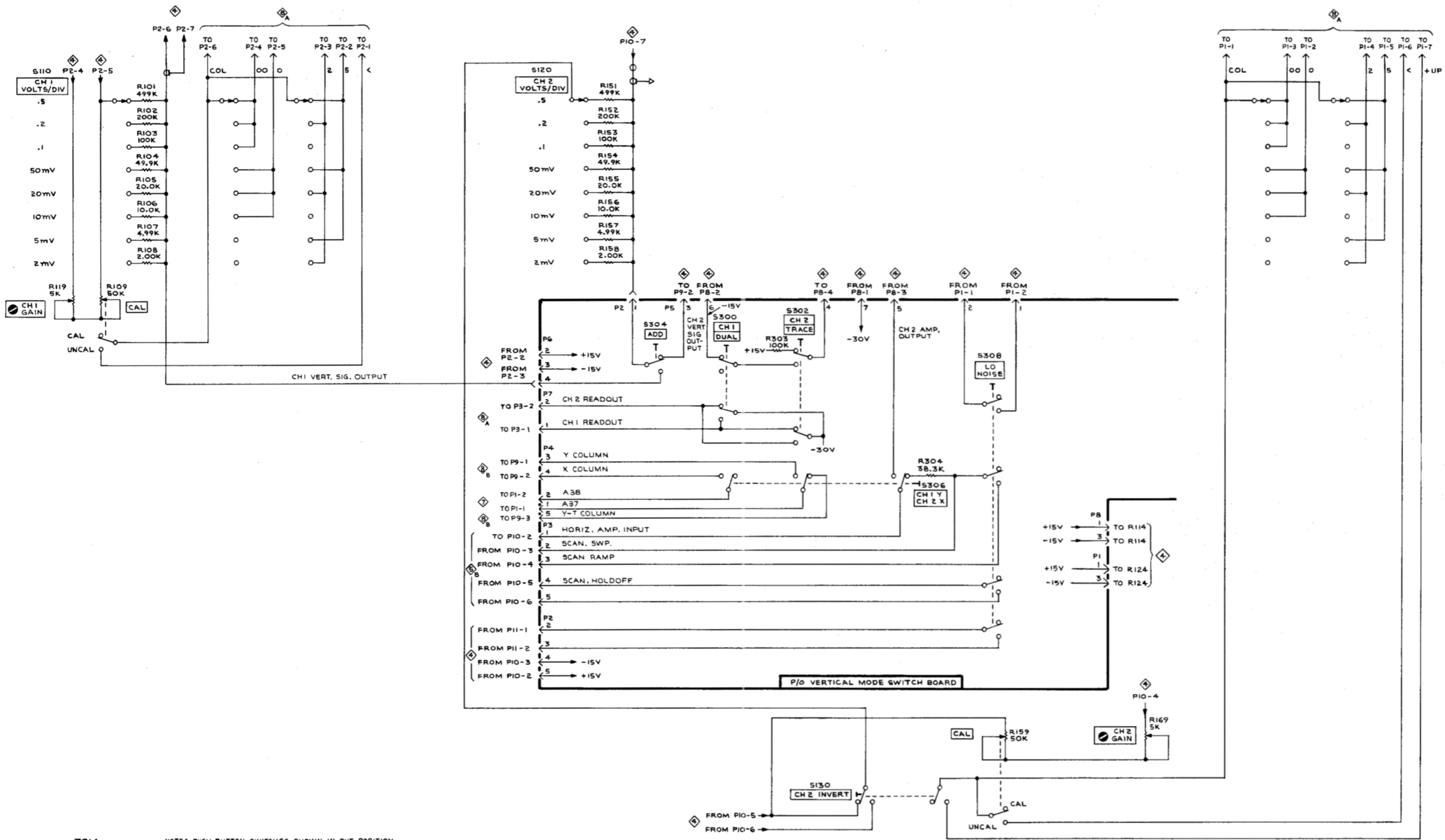

7S14

NOTE: PUSH BUTTON SWITCHES SHOWN IN OUT POSITION

REV JUN 1984

ATTENUATOR & MODE SWITCHES 3

473 EKP

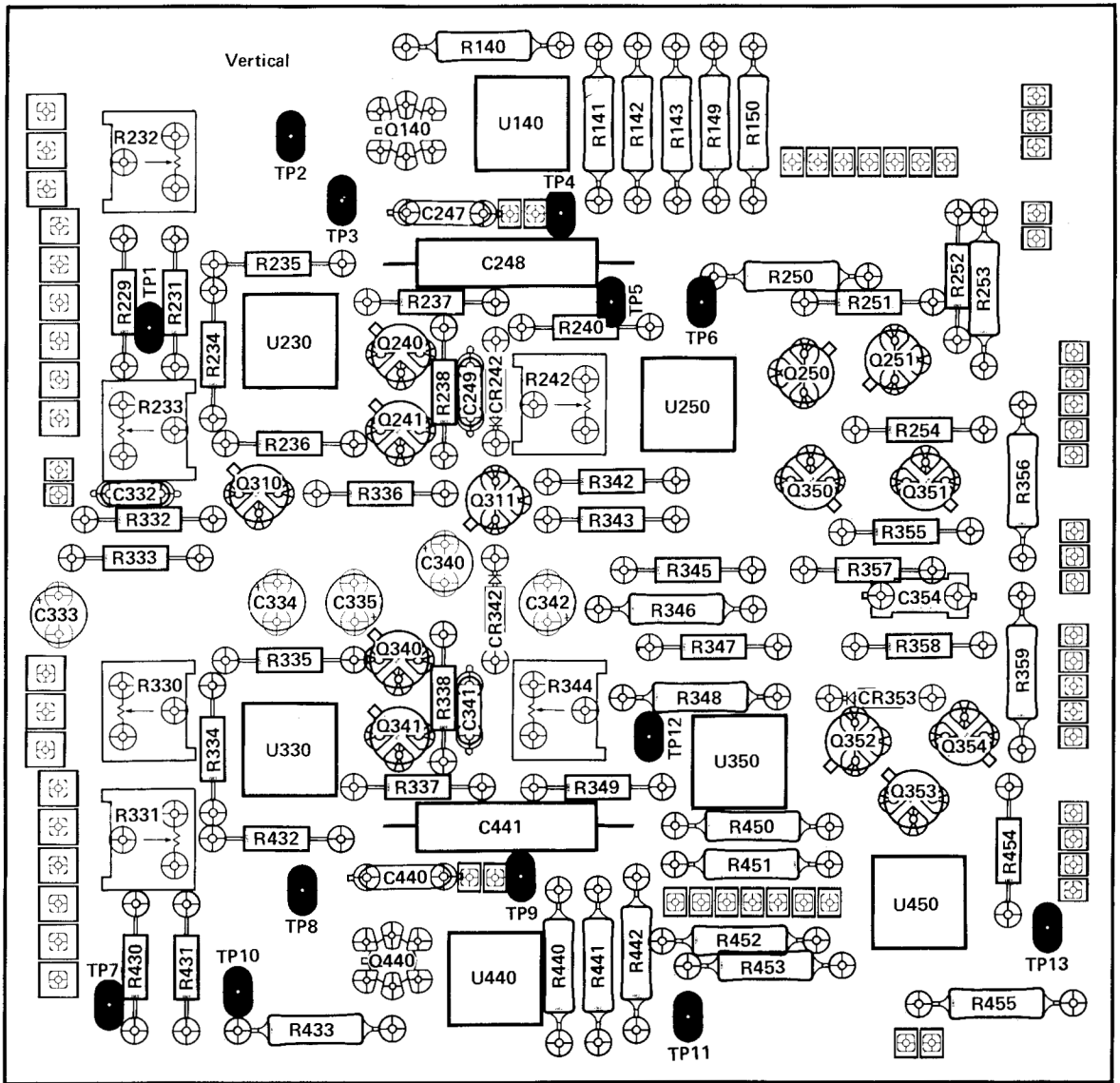

1

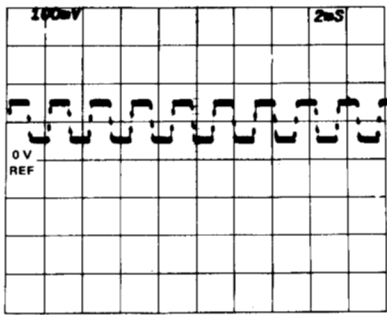

2

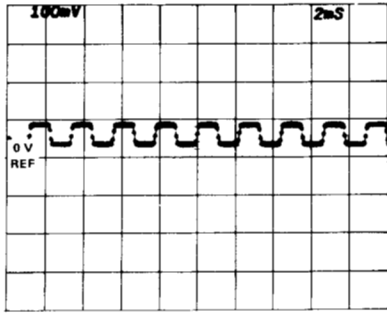

3

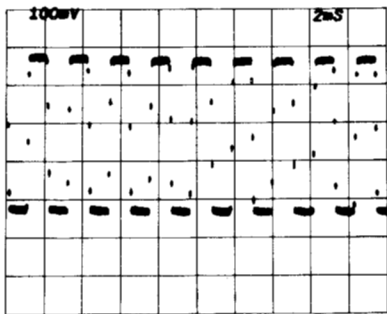

4

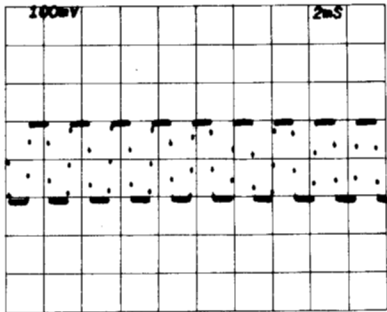

5

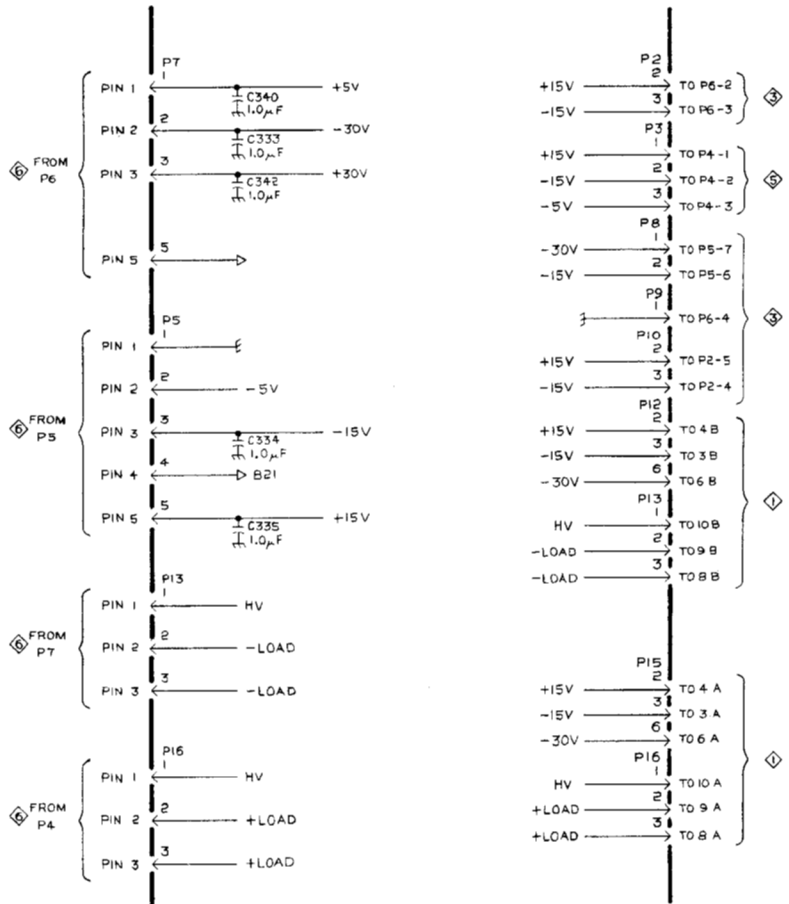
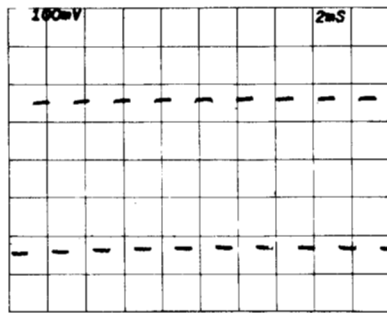

VERTICAL BOARD POWER SUPPLIES

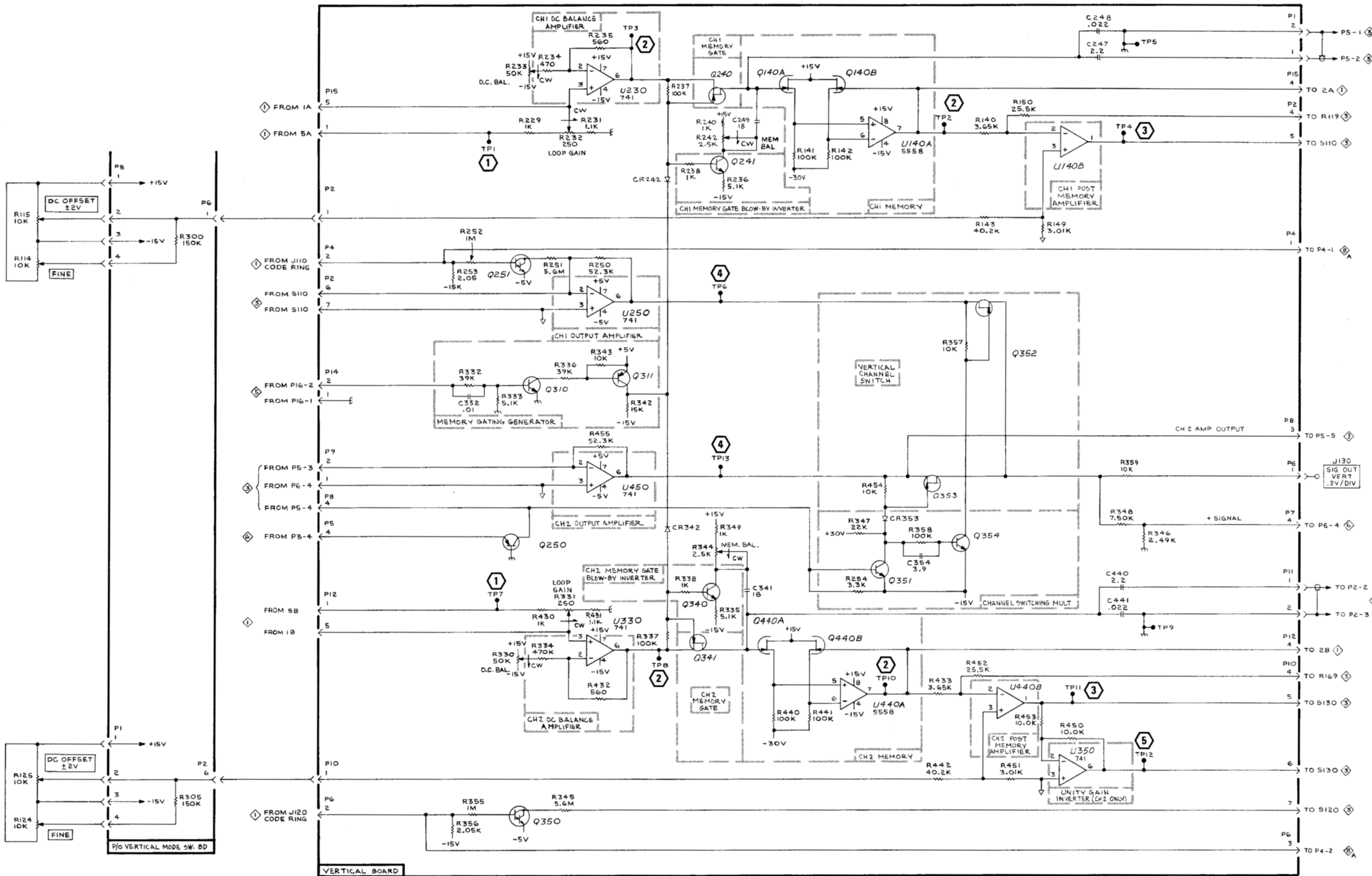

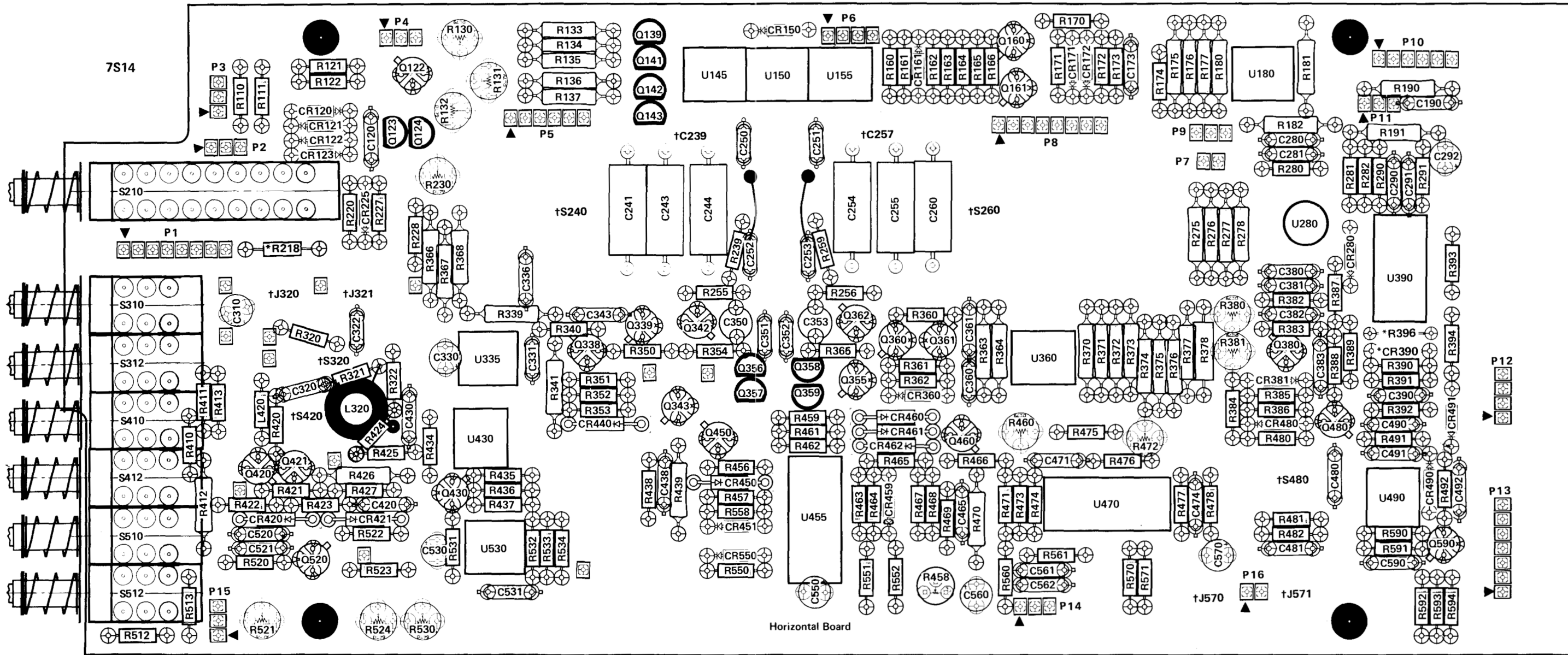

*See Parts List for serial number ranges.

Horizontal Board 5 A, 5 B, 5 C

REV. C APR 1977

†(on back)

1

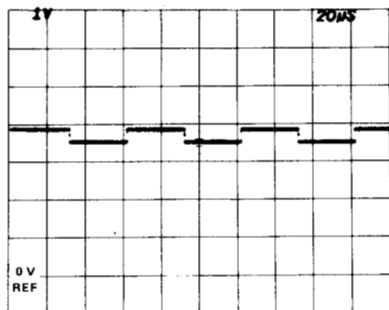

2

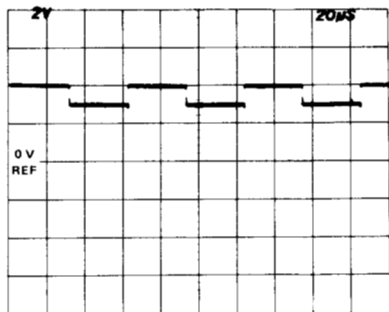

3

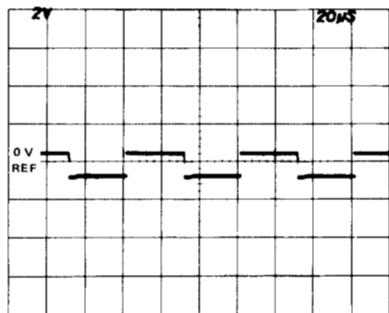

4

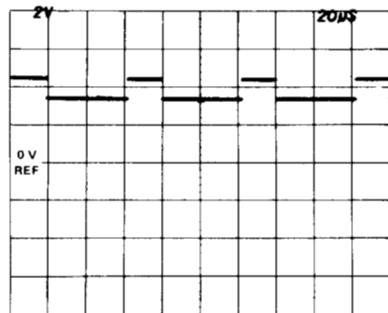

5

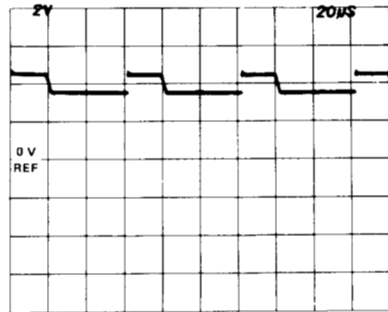

6

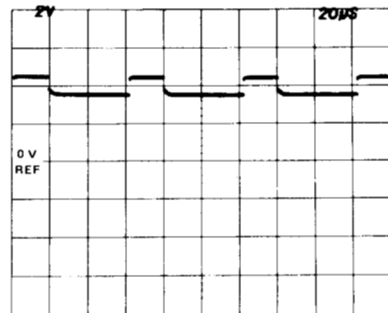

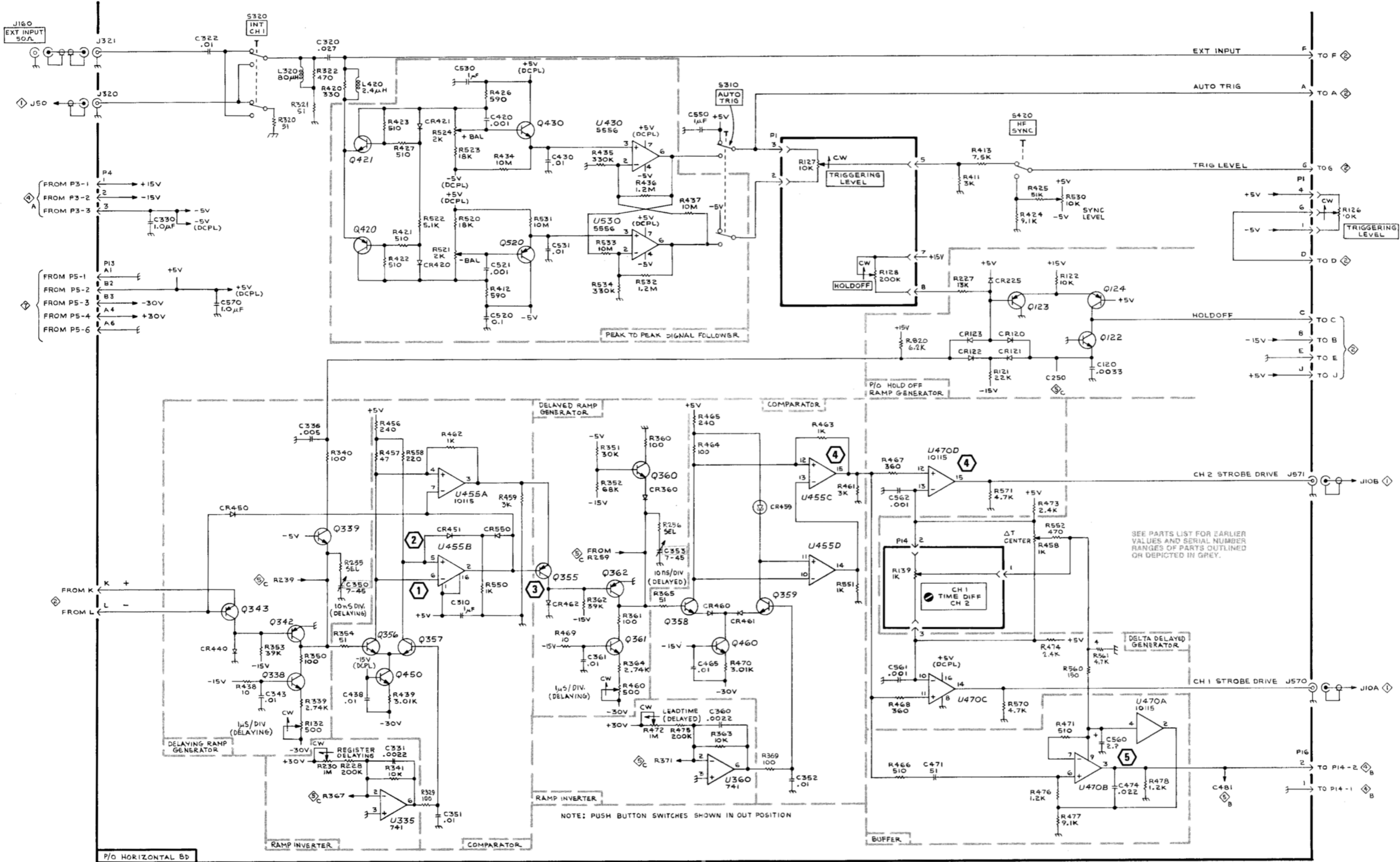

7

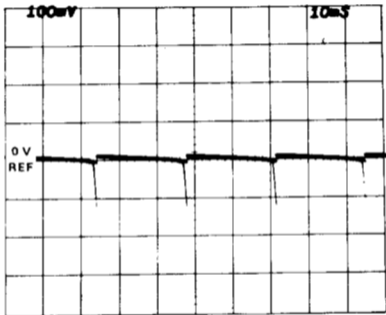

8

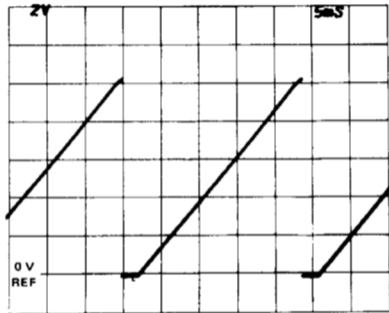

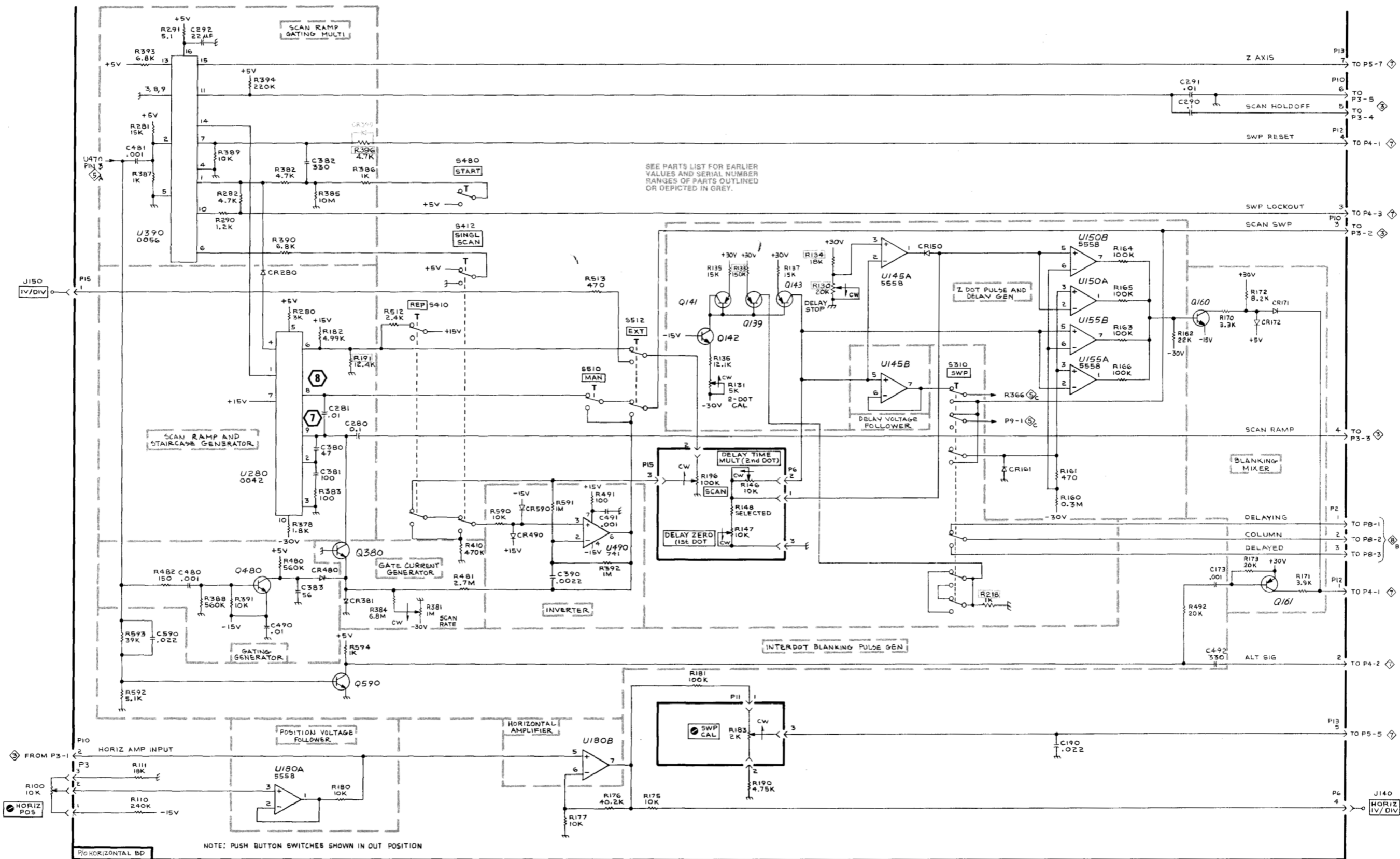

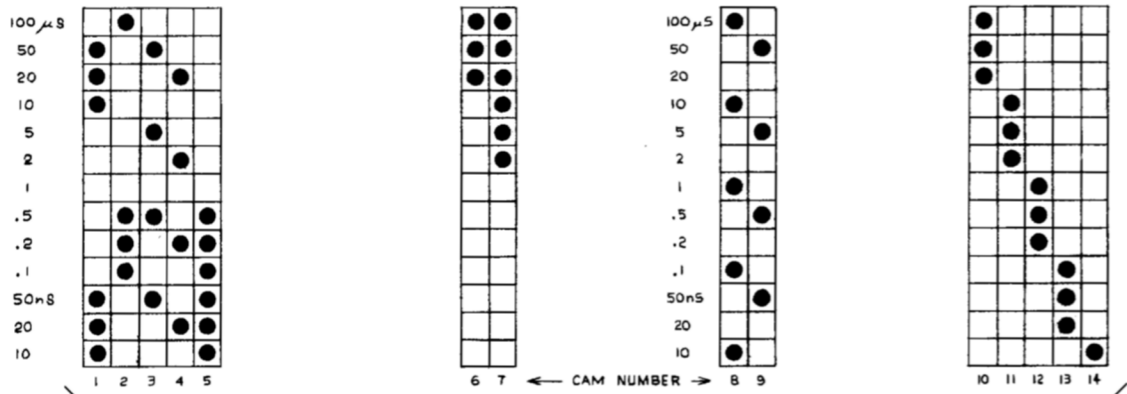
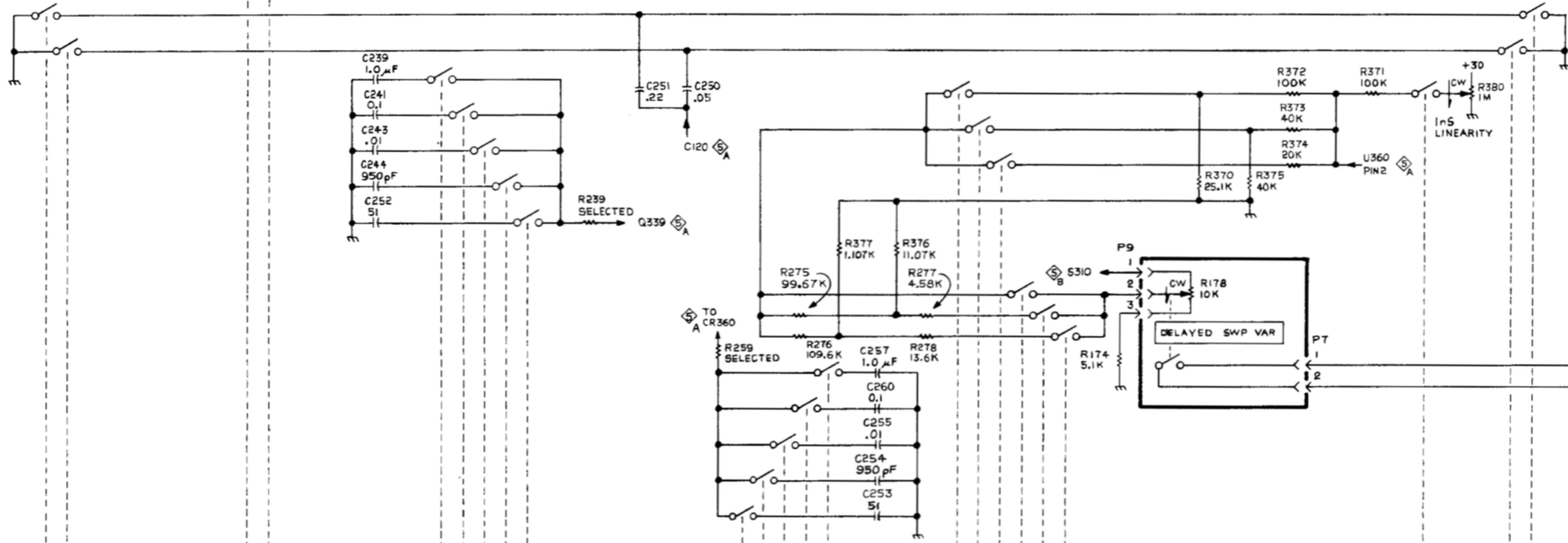
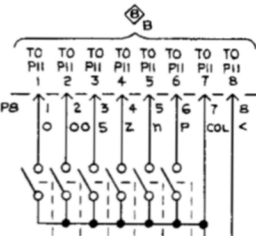
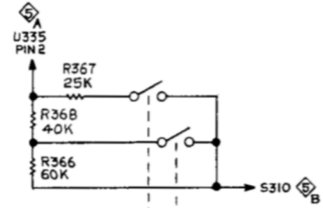
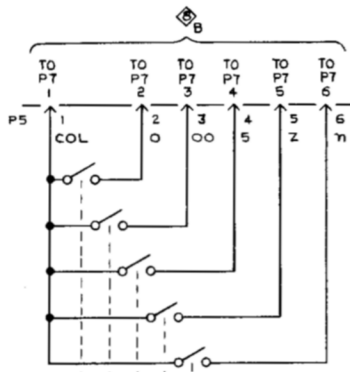

DELAYING SWEEP
SEC / DIV
5240

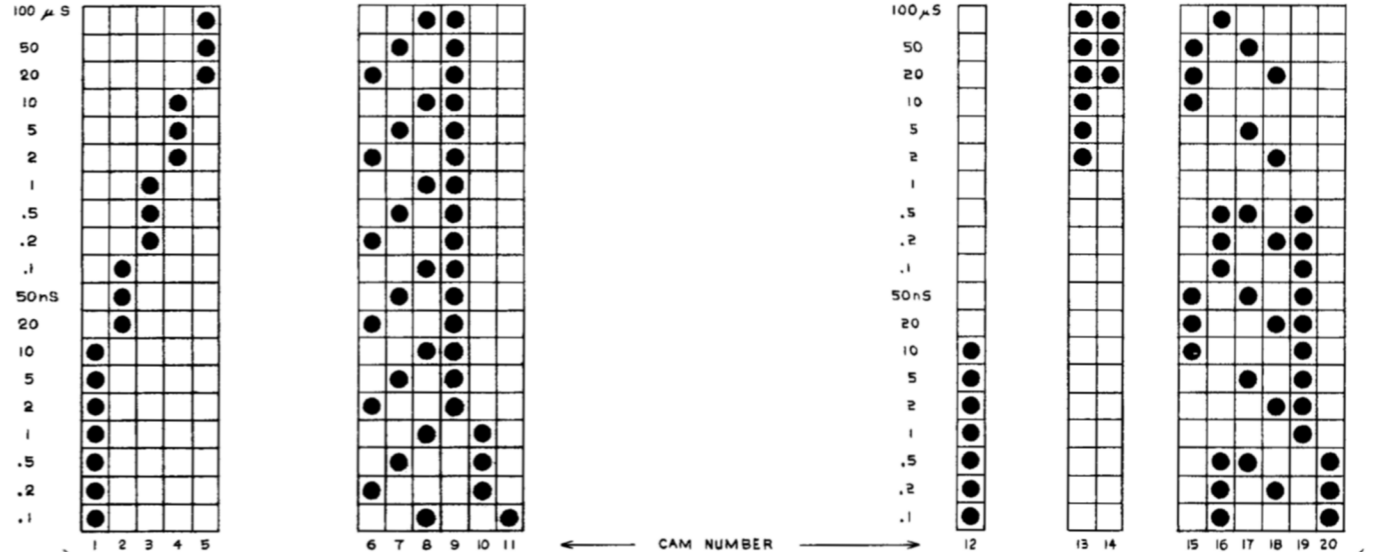

DELAYING SWEEP
SEC / DIV
5260

7S14

7S14 Vert
Interface

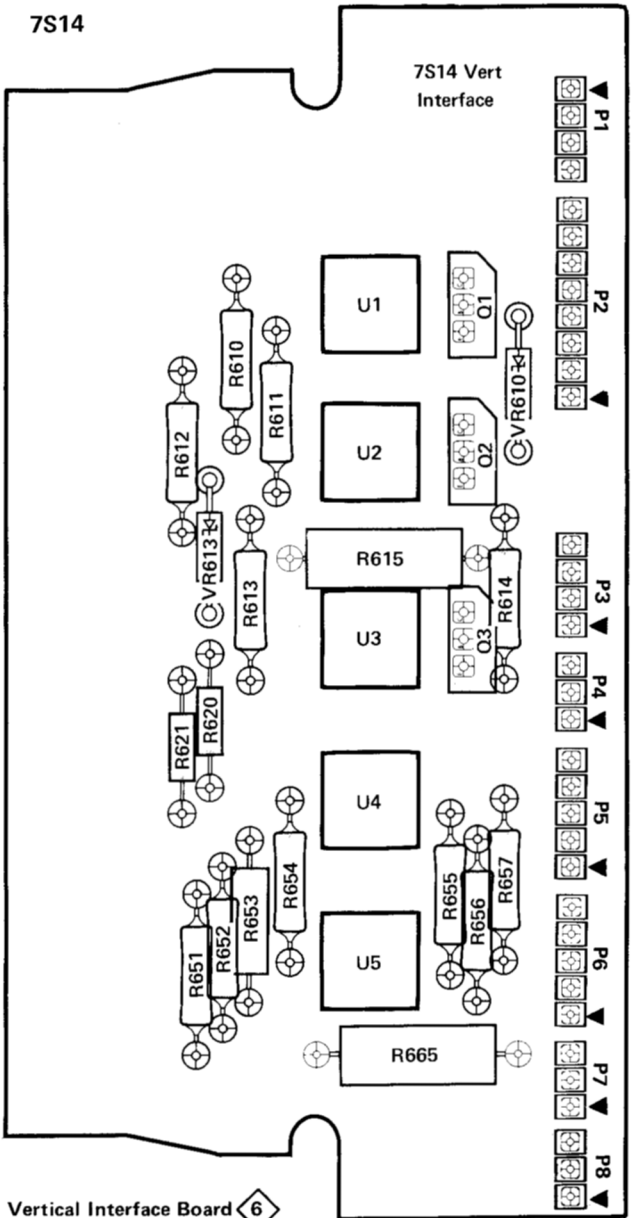

Vertical Interface Board 6

REV APR 1982

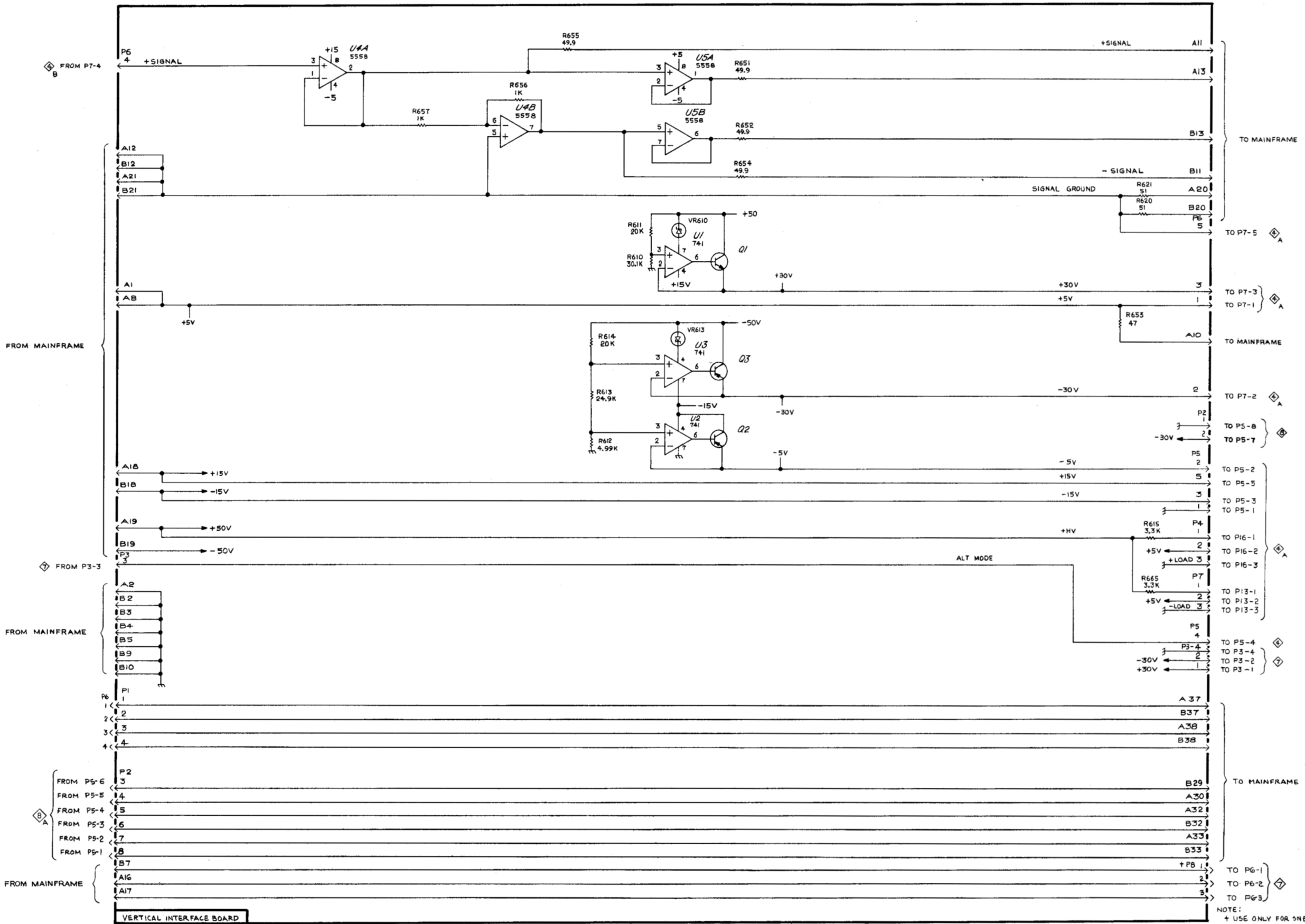

VERTICAL INTERFACE BOARD

NOTE:
+ USE ONLY FOR 5NB050000 UP.

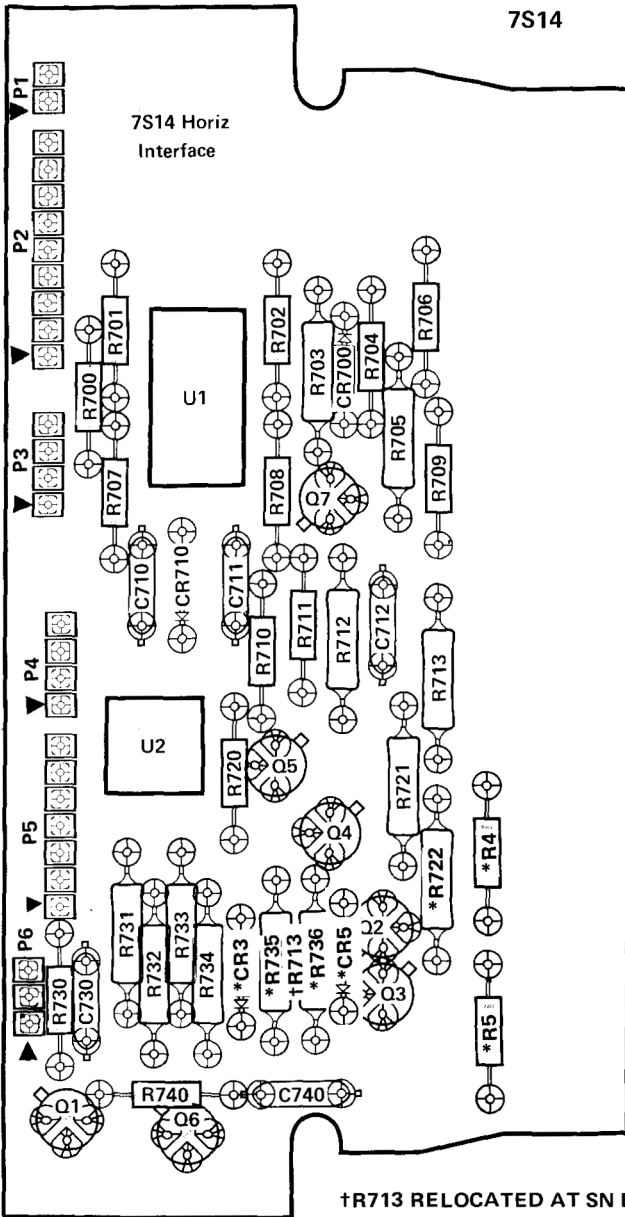

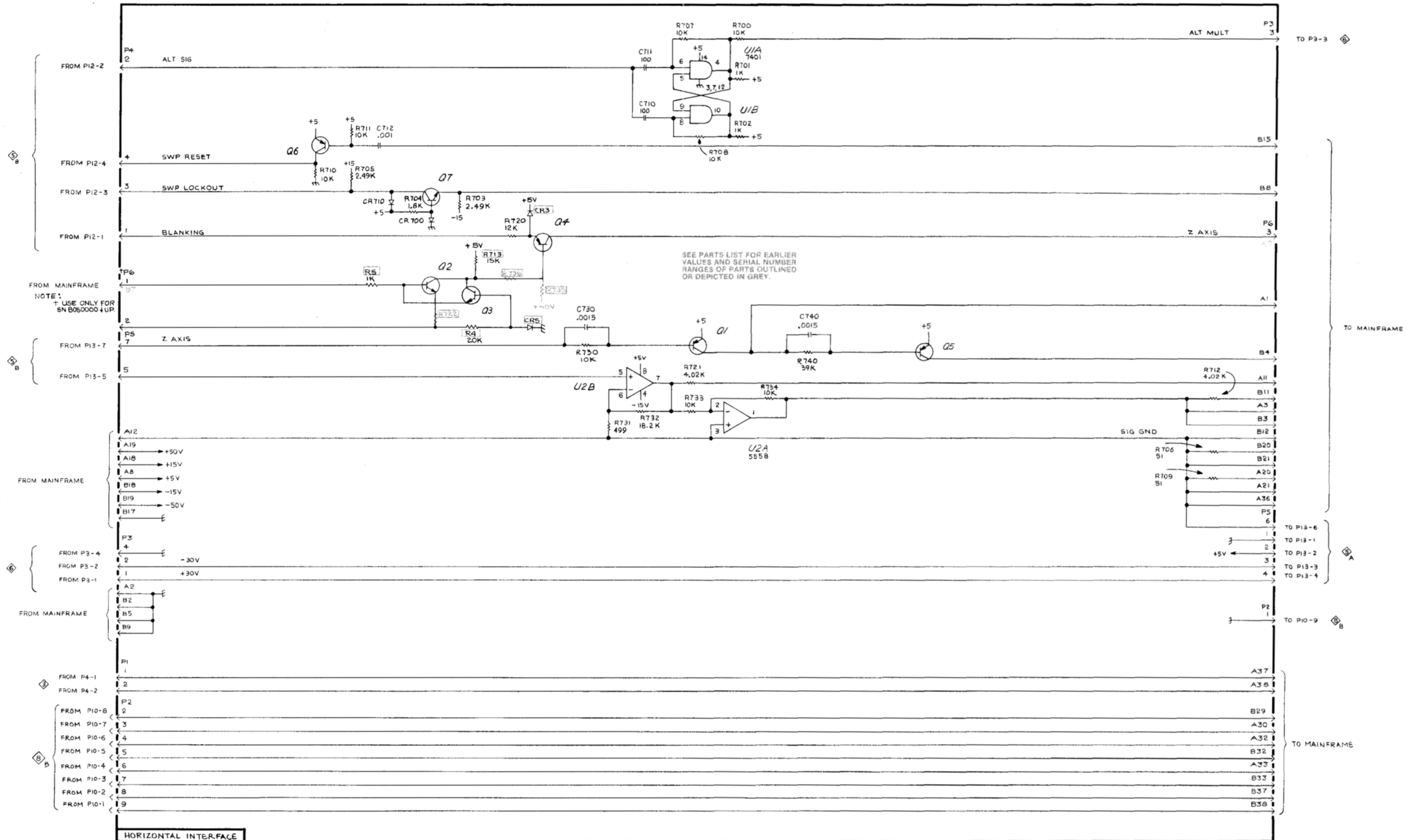

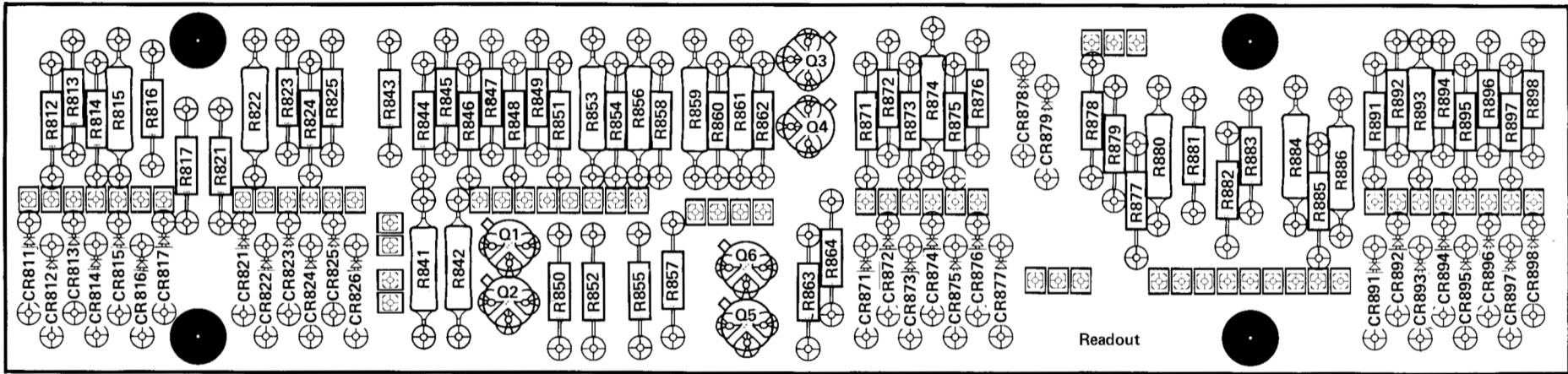

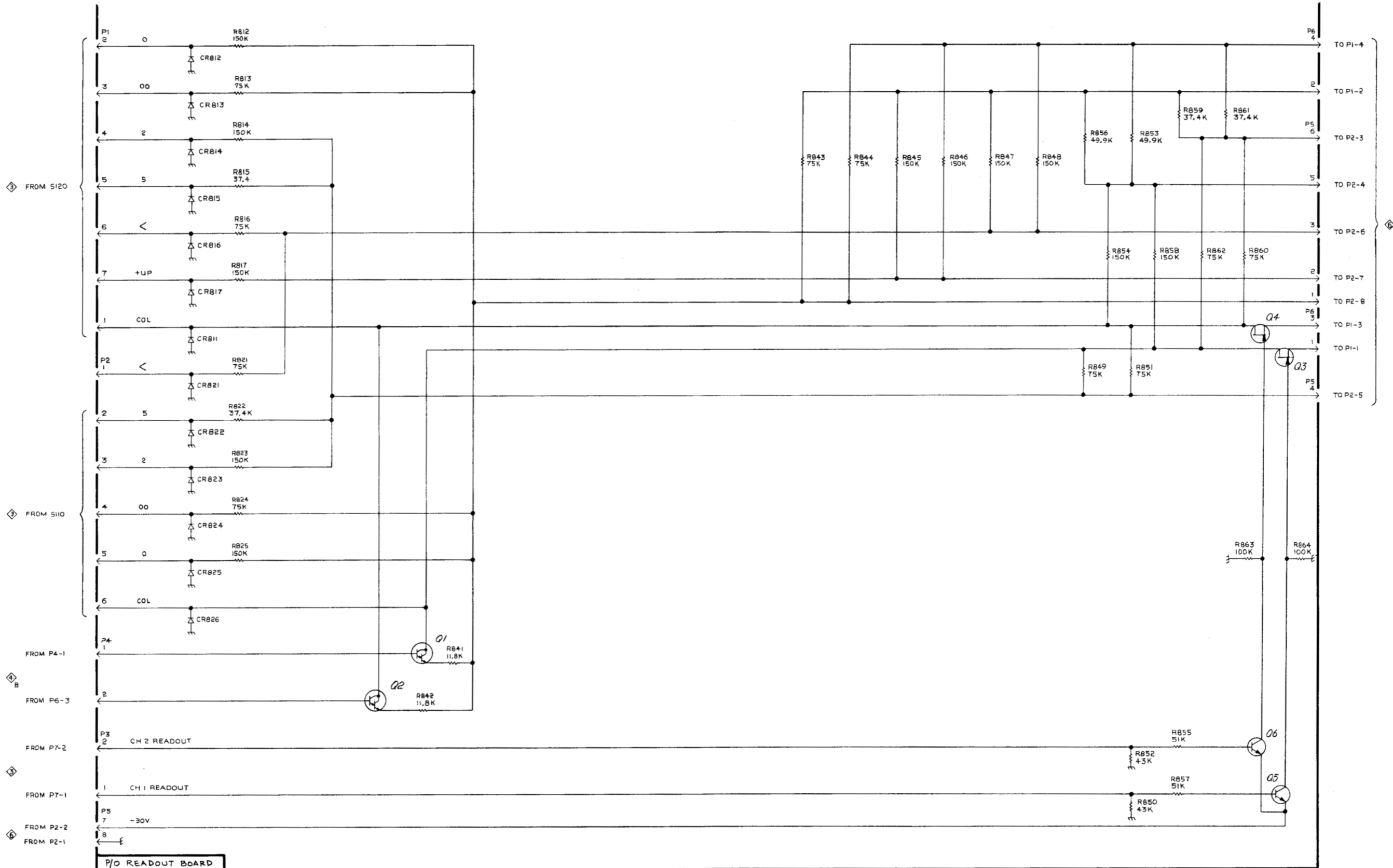

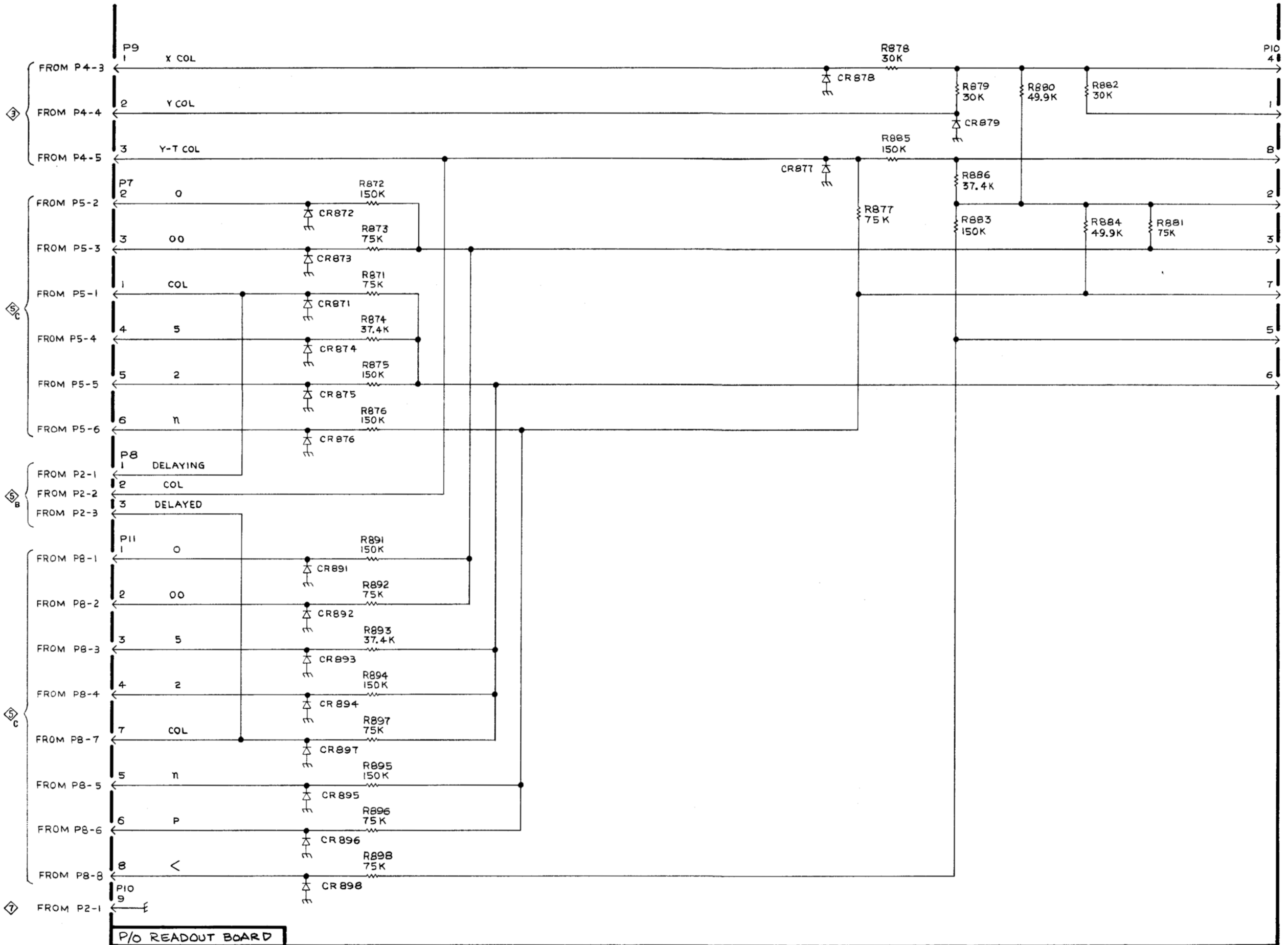

P/O READOUT BOARD

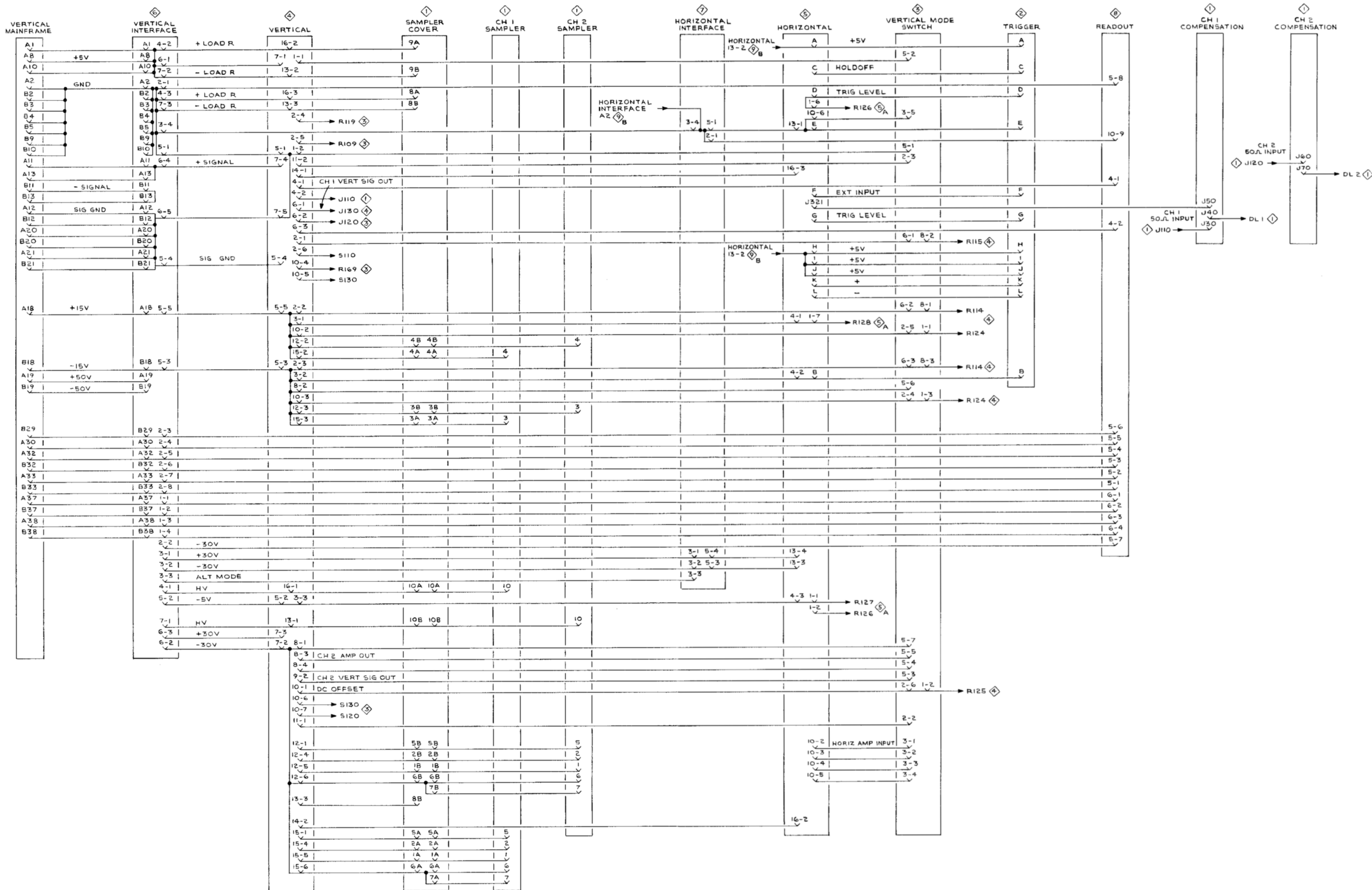

HORIZONTAL MAINFRAME

HORIZONTAL INTERFACE

HORIZONTAL

READOUT

VERTICAL MODE SWITCH

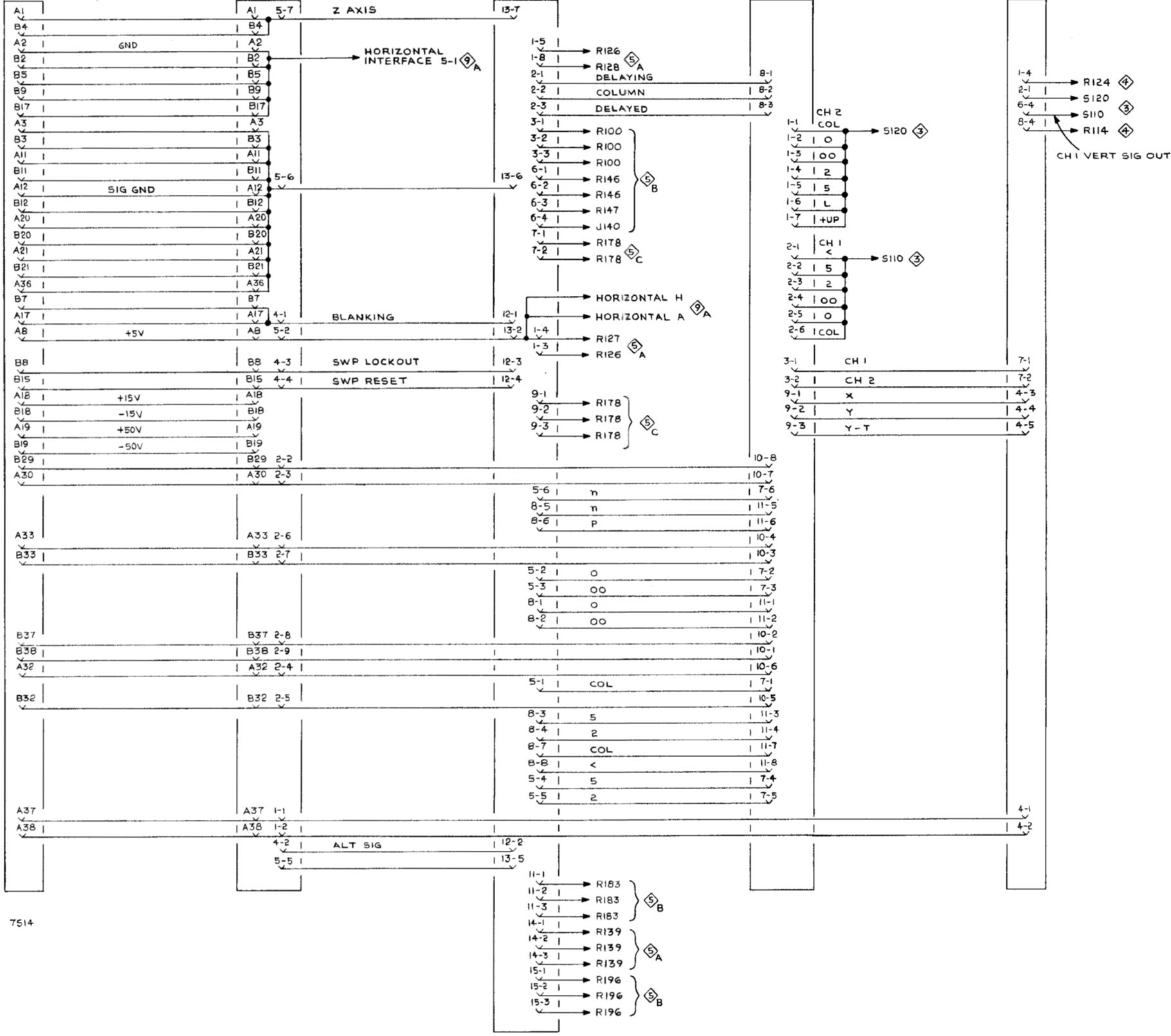

7514

REPLACEABLE MECHANICAL PARTS

PARTS ORDERING INFORMATION

Replacement parts are available from or through your local Tektronix, Inc. Field Office or representative.

Changes to Tektronix instruments are sometimes made to accommodate improved components as they become available, and to give you the benefit of the latest circuit improvements developed in our engineering department. It is therefore important, when ordering parts, to include the following information in your order: Part number, instrument type or number, serial number, and modification number if applicable.

If a part you have ordered has been replaced with a new or improved part, your local Tektronix, Inc. Field Office or representative will contact you concerning any change in part number.

Change information, if any, is located at the rear of this manual.

SPECIAL NOTES AND SYMBOLS

X000 Part first added at this serial number
00X Part removed after this serial number

FIGURE AND INDEX NUMBERS

Items in this section are referenced by figure and index numbers to the illustrations.

INDENTATION SYSTEM

This mechanical parts list is indented to indicate item relationships. Following is an example of the indentation system used in the description column.

```

1 2 3 4 5           Name & Description
Assembly and/or Component
Attaching parts for Assembly and/or Component
    --- * ---
Detail Part of Assembly and/or Component
Attaching parts for Detail Part
    --- * ---
Parts of Detail Part
Attaching parts for Parts of Detail Part
    --- * ---
  
```

Attaching Parts always appear in the same indentation as the item it mounts, while the detail parts are indented to the right. Indented items are part of, and included with, the next higher indentation. The separation symbol --- * --- indicates the end of attaching parts.

Attaching parts must be purchased separately, unless otherwise specified.

ITEM NAME

In the Parts List, an Item Name is separated from the description by a colon (:). Because of space limitations, an Item Name may sometimes appear as incomplete. For further Item Name identification, the U.S. Federal Cataloging Handbook H6-1 can be utilized where possible.

ABBREVIATIONS

INCH	ELECTRN	ELECTRON	IN	INCH	SE	SINGLE END
# NUMBER SIZE	ELEC	ELECTRICAL	INCAND	INCANDESCENT	SECT	SECTION
ACTR ACTUATOR	ELECTLT	ELECTROLYTIC	INSUL	INSULATOR	SEMICON	SEMICONDUCTOR
ADPTR ADAPTER	ELEM	ELEMENT	INTL	INTERNAL	SHLD	SHIELD
ALIGN ALIGNMENT	EPL	ELECTRICAL PARTS LIST	LPHLDR	LAMPHOLDER	SHLDR	SHOULDERED
AL ALUMINUM	EQPT	EQUIPMENT	MACH	MACHINE	SKT	SOCKET
ASSEM ASSEMBLED	EXT	EXTERNAL	MECH	MECHANICAL	SL	SLIDE
ASSY ASSEMBLY	FIL	FILLISTER HEAD	MTG	MOUNTING	SLFLKG	SELF-LOCKING
ATTEN ATTENUATOR	FLEX	FLEXIBLE	NIP	NIPPLE	SLVG	SLEEVING
AWG AMERICAN WIRE GAGE	FLH	FLAT HEAD	NON WIRE	NOT WIRE WOUND	SPR	SPRING
BD BOARD	FLTR	FILTER	OBD	ORDER BY DESCRIPTION	SQ	SQUARE
BRKT BRACKET	FR	FRAME or FRONT	OD	OUTSIDE DIAMETER	SST	STAINLESS STEEL
BRS BRASS	FSTNR	FASTENER	OVH	OVAL HEAD	STL	STEEL
BRZ BRONZE	FT	FOOT	PH BRZ	PHOSPHOR BRONZE	SW	SWITCH
BSHG BUSHING	FXD	FIXED	PL	PLAIN or PLATE	T	TUBE
CAB CABINET	GSKT	GASKET	PLSTC	PLASTIC	TERM	TERMINAL
CAP CAPACITOR	HDL	HANDLE	PN	PART NUMBER	THD	THREAD
CER CERAMIC	HEX	HEXAGON	PNH	PAN HEAD	THK	THICK
CHAS CHASSIS	HEX HD	HEXAGONAL HEAD	PWR	POWER	TNSN	TENSION
CKT CIRCUIT	HEX SOC	HEXAGONAL SOCKET	RCPT	RECEPTACLE	TPG	TAPPING
COMP COMPOSITION	HLCPS	HELICAL COMPRESSION	RES	RESISTOR	TRH	TRUSS HEAD
CONN CONNECTOR	HLEXT	HELICAL EXTENSION	RGD	RIGID	V	VOLTAGE
COV COVER	HV	HIGH VOLTAGE	RLF	RELIEF	VAR	VARIABLE
CPLG COUPLING	IC	INTEGRATED CIRCUIT	RTNR	RETAINER	W	WITH
CRT CATHODE RAY TUBE	ID	INSIDE DIAMETER	SCH	SOCKET HEAD	WSHR	WASHER
DEG DEGREE	IDNT	IDENTIFICATION	SCH	OSCILLOSCOPE	XFMR	TRANSFORMER
DWR DRAWER	IMPLR	IMPELLER	SCR	SCREW	XSTR	TRANSISTOR

Replaceable Mechanical Parts—7S14

CROSS INDEX—MFR. CODE NUMBER TO MANUFACTURER

Mfr. Code	Manufacturer	Address	City, State, Zip
000BB	BERQUIST COMPANY	4350 WEST 78TH	MINNEAPOLIS, MN 55435
000CY	NORTHWEST FASTENER SALES, INC.	7923 SW CIRRUS DRIVE	BEAVERTON, OR 97005
00141	PIC DESIGN DIVISION, BENRUS CORPORATION	P O BOX 335, BENRUS CENTER	RIDGEFIELD, CT 06877
00779	AMP, INC.	P.O. BOX 3608	HARRISBURG, PA 17105
05129	KILO ENGINEERING COMPANY	2015 D	LA VERNE, CA 91750
08261	SPECTRA-STRIP CORP.	7100 LAMPSON AVE.	GARDEN GROVE, CA 92642
12327	FREEWAY CORPORATION	9301 ALLEN DRIVE	CLEVELAND, OH 44125
18203	ENGELMANN MICROWAVE CO.	SKYLINE DR.	MONTVILLE, NJ 07045
22526	BERG ELECTRONICS, INC.	YOUK EXPRESSWAY	NEW CUMBERLAND, PA 17070
22599	ESNA, DIV. OF AMERACE CORPORATION	16150 STAGG STREET	VAN NUYS, CA 91409
24931	SPECIALITY CONNECTOR CO., INC.	2620 ENDRESS PLACE	GREENWOOD, IN 46142
57668	R-OHM CORP.	16931 MILLIKEN AVE.	IRVINE, CA 92713
71159	BRISTOL SOCKET SCREW, DIV. OF AMERICAN CHAIN AND CABLE CO., INC.	P O BOX 2244, 40 BRISTOL ST.	WATERBURY, CT 06720
73743	FISCHER SPECIAL MFG. CO.	446 MORGAN ST.	CINCINNATI, OH 45206
78189	ILLINOIS TOOL WORKS, INC. SHAKEPROOF DIVISION	ST. CHARLES ROAD	ELGIN, IL 60120
79136	WALDES, KOHINOOR, INC.	47-16 AUSTEL PLACE	LONG ISLAND CITY, NY 11101
79807	WROUGHT WASHER MFG. CO.	2100 S. O BAY ST.	MILWAUKEE, WI 53207
80009	TEKTRONIX, INC.	P O BOX 500	BEAVERTON, OR 97077
83385	CENTRAL SCREW CO.	2530 CRESCENT DR.	BROADVIEW, IL 60153
86928	SEASTROM MFG. COMPANY, INC.	701 SONORA AVENUE	GLENDALE, CA 91201
87308	N. L. INDUSTRIES, INC., SOUTHERN SCREW DIV.	P. O. BOX 1360	STATESVILLE, NC 28677
89663	REESE, J. RAMSEY, INC.	71 MURRAY STREET	NEW YORK, NY 10007
92101	SCHULZE MFG, 50 INGOLD RD BURLINGAME, CA 94010		
93907	TEXTRON INC. CAMCAR DIV	600 18TH AVE	ROCKFORD, IL 61101
98291	SEAELECTRO CORP.	225 HOYT	MAMARONECK, NY 10544

Fig. & Index No.	Tektronix Part No.	Serial/Model No. Eff	Dscont	Qty	1	2	3	4	5	Name & Description	Mfr Code	Mfr Part Number
1-1	337-1163-01			2						SHLD.ELECTRICAL:RIGHT SIDE	80009	337-1163-01
-2	-----			1						RESISTOR,VARIABLE:(SEE R146 REPL) ***** (ATTACHING PARTS)*****		
-3	331-0247-00			1						DIAL,CONTROL:10 TURN ***** (END ATTACHING PARTS)*****	05129	771-S-1
-4	366-0494-00			2						KNOB:GRAY WITH SETSCREW	80009	366-0494-00
	213-0153-00			2						.SETSCREW:5-40 X 0.125,STL BK OXD,HEX	000CY	OBD
-5	366-1463-00			1						KNOB:GRAY	80009	366-1463-00
	213-0153-00			1						.SETSCREW:5-40 X 0.125,STL BK OXD,HEX	000CY	OBD
-6	366-1478-00			1						KNOB:GRAY	80009	366-1478-00
	213-0153-00			2						.SETSCREW:5-40 X 0.125,STL BK OXD,HEX	000CY	OBD
-7	358-0414-00			1						BUSHING,SLEEVE:0.25 OD X 0.21 INCH LONG	80009	358-0414-00
-8	366-1476-00			1						KNOB:GRAY	80009	366-1476-00
	213-0153-00			2						.SETSCREW:5-40 X 0.125,STL BK OXD,HEX	000CY	OBD
-9	366-1319-02			3						KNOB:GY,0.79 ID,0.28 OD,0.32 H	80009	366-1319-02
-10	366-1077-00			3						KNOB:GRAY	80009	366-1077-00
	213-0153-00			3						.SETSCREW:5-40 X 0.125,STL BK OXD,HEX	000CY	OBD
-11	366-1464-00			2						KNOB:GRAY	80009	366-1464-00
	213-0153-00			2						.SETSCREW:5-40 X 0.125,STL BK OXD,HEX	000CY	OBD
-12	366-1165-00			2						KNOB:GRAY	80009	366-1165-00
	213-0153-00			4						.SETSCREW:5-40 X 0.125,STL BK OXD,HEX	000CY	OBD
-13	366-1058-53			1						KNOB:LATCH,7S14 ***** (ATTACHING PARTS)*****	80009	366-1058-00
-14	214-1095-00			1						PIN,SPG,SPLIT:0.094 OD X 0.187 INCH LONG ***** (END ATTACHING PARTS)*****	22599	52-022-094-0187
-15	105-0076-02	B010100	B101494	1						REL BAR,LATCH:PLUG-IN UNIT	80009	105-0076-02
	105-0076-04	B0101495		1						RELEASE BAR,LCH:PLUG-IN UNIT	80009	105-0076-04
-16	214-1280-00			1						SPRING,HLCPS:0.14 OD X 1.126" L,0.16" DIA	80009	214-1280-00
-17	105-0075-00			1						BOLT,LATCH:7A & 7B SER PL-IN	80009	105-0075-00
-18	214-1054-00			1						SPRING,FLAT:0.825 X 0.322,SST	80009	214-1054-00
-19	348-0235-00			2						SHLD GSKT,ELEC:4.734 INCH LONG	92101	OBD
-20	131-1171-00			2						CONNECTOR,RCPT.:BNC,50 OHM	24931	28JR231-1
-21	131-1315-01			1						CONN,RCPT,ELEC:BNC,FEMALE	24931	28JR 306-1
-22	358-0029-00			1						BSHG,MACH,THD:HEX,0.375-32 X 0.438" LONG ***** (ATTACHING PARTS)*****	80009	358-0029-00
-23	210-0413-00			1						NUT,PLAIN,HEX.:0.375-32 X 0.50 INCH,STL	73743	3145-402
-24	210-0012-00			1						WASHER,LOCK:INTL,0.375 ID X 0.50" OD S ***** (END ATTACHING PARTS)*****	78189	1220-02-00-0541C
-25	-----			2						SWITCH,WIRED:SEE S110,S120 REPL ***** (ATTACHING PARTS)*****		
-26	210-0413-00			2						NUT,PLAIN,HEX.:0.375-32 X 0.50 INCH,STL	73743	3145-402
-27	210-0840-00			2						WASHER,FLAT:0.39 ID X 0.562 INCH OD,STL ***** (END ATTACHING PARTS)*****	89663	644R
-28	-----			-						EACH SWITCH INCLUDES: .RESISTOR,VAR:(SEE R109 REPL) ***** (ATTACHING PARTS)*****		
-29	210-0583-00			1						NUT,PLAIN,HEX:0.25-32 X 0.312 INCH,BRS	73743	2X20317-402
-30	210-0046-00			1						WASHER,LOCK:0.261 ID,INTL,0.018 THK,BRS ***** (END ATTACHING PARTS)*****	78189	1214-05-00-0541C
-31	-----			1						RESISTOR,VAR:(SEE R196 REPL) ***** (ATTACHING PARTS)*****		
-32	210-0583-00			1						NUT,PLAIN,HEX:0.25-32 X 0.312 INCH,BRS	73743	2X20317-402
-33	210-0940-00			1						WASHER,FLAT:0.25 ID X 0.375 INCH OD,STL	79807	OBD
-34	361-0143-00			1						WASHER,KEY:0.281 ID X 0.562 INCH OD ***** (END ATTACHING PARTS)*****	80009	361-0143-00
-35	-----			2						RESISTOR,VAR:(SEE R114,R115,R124,R125 REPL) ***** (ATTACHING PARTS)*****		

Replaceable Mechanical Parts—7S14

Fig. & Index No.	Tektronix Part No.	Serial/Model No. Eff	Dscont	Qty	1 2 3 4 5	Name & Description	Mfr Code	Mfr Part Number
1-36	210-0583-00			2		NUT,PLAIN,HEX.:0.25-32 X 0.312 INCH.BRS	73743	2X20317-402
	210-0465-00	B110000		2		NUT,PLAIN,HEX.:0.25-32 X 0.375 INCH BRS	73743	3095-402
-37	210-0940-00			2		WASHER,FLAT:0.25 ID X 0.375 INCH OD.STL	79807	OBD
-38	210-0046-00	B010100	B109999	2		WASHER,LOCK:0.261 ID,INTL,0.018 THK.BRS	78189	1214-05-00-0541C
	210-0046-00	B110000		4		WASHER,LOCK:0.261 ID,INTL,0.018 THK.BRS ***** (ATTACHING PARTS) *****	78189	1214-05-00-0541C
-38.1	-----			1		RESISTOR,VAR:(SEE R174 REPL) ***** (ATTACHING PARTS) *****		
-38.2	210-0583-00			1		NUT,PLAIN,HEX.:0.25-32 X 0.312 INCH.BRS	73743	2X20317-402
-38.3	210-0940-00			1		WASHER,FLAT:0.25 ID X 0.375 INCH OD.STL ***** (ATTACHING PARTS) *****	79807	OBD
-39	-----			2		RESISTOR,VAR:(SEE R126,R127,R128 REPL) ***** (ATTACHING PARTS) *****		
-40	210-0583-00			2		NUT,PLAIN,HEX.:0.25-32 X 0.312 INCH.BRS	73743	2X20317-402
-41	210-0940-00			2		WASHER,FLAT:0.25 ID X 0.375 INCH OD.STL ***** (ATTACHING PARTS) *****	79807	OBD
-42	-----			2		RESISTOR,VAR:(SEE R119,R169 REPL)		
-43	220-0510-00			2		NUT,PLAIN,HEX.:0.25-32 X 0.312 INCH ***** (ATTACHING PARTS) *****	80009	220-0510-00
-44	358-0342-00			2		BSHG,MACH,THD:0.25 X 32 X 0.352 INCH LONG ***** (ATTACHING PARTS) *****	80009	358-0342-00
-45	-----			1		RESISTOR,VAR:(SEE R139 REPL)		
-46	210-0471-00			1		NUT,SLEEVE,HEX.,0.312 X 0.594 INCH LON ***** (ATTACHING PARTS) *****	80009	210-0471-00
-47	358-0409-00			1		BSHG,MACH,THD:0.25-32 X 0.159 ID X 0.24 ***** (ATTACHING PARTS) *****	80009	358-0409-00
-48	210-0046-00			3		WASHER,LOCK:0.261 ID,INTL,0.018 THK.BRS	78189	1214-05-00-0541C
-49	-----			1		RESISTOR,VAR:(SEE R183 REPL)		
-50	210-0223-00			1		TERMINAL,LUG:0.25 INCH DIA,SE	86928	A313-136
-51	220-0510-00			1		NUT,PLAIN,HEX.:0.25-32 X 0.312 INCH ***** (ATTACHING PARTS) *****	80009	220-0510-00
-52	358-0342-00			1		BSHG,MACH,THD:0.25 X 32 X 0.352 INCH LONG ***** (ATTACHING PARTS) *****	80009	358-0342-00
-53	-----			1		RESISTOR,VAR:(SEE R100 REPL)		
-54	210-0046-00			1		WASHER,LOCK:0.261 ID,INTL,0.018 THK.BRS	78189	1214-05-00-0541C
-55	129-0454-00			1		POST,ELEC-MECH:0.25-32 X 0.312 X 0.70" LONG ***** (ATTACHING PARTS) *****	80009	129-0454-00
-56	358-0342-00			1		BSHG,MACH,THD:0.25 X 32 X 0.352 INCH LONG ***** (ATTACHING PARTS) *****	80009	358-0342-00
-57	366-1257-32			1		PUSH BUTTON:GRAY-INVERT	80009	366-1257-32
-58	-----			1		SWITCH,PUSH:(SEE S130 REPL) ***** (ATTACHING PARTS) *****		
-59	211-0022-00			2		SCREW,MACHINE:2-56 X 0.188 INCH.PNH STL ***** (ATTACHING PARTS) *****	83385	OBD
-60	129-0438-00			2		POST,ELEC-MECH:2.56 X 0.188 X 0.458" LONG ***** (ATTACHING PARTS) *****	80009	129-0438-00
-61	211-0030-00			2		SCREW,MACHINE:2-56 X 0.25" 82 DEG,FLH STL ***** (ATTACHING PARTS) *****	83385	OBD
-62	333-1676-00			1		PANEL,FRONT:	80009	333-1676-00
-63	426-0681-00			16		FR,PUSH BUTTON:GRAY PLASTIC	80009	426-0681-00
-64	131-0779-00			3		JACK,TIP:FOR 0.08 INCH DIA TEST POI	98291	016-8010-00-0208
-65	352-0181-01			3		HOLDER,TIP JACK:1.308 X 0.30 X 0.25" PLSTC ***** (ATTACHING PARTS) *****	80009	352-0181-01
-66	211-0038-00			3		SCREW,MACHINE:4-40 X 0.312,FLH,100 DEG ***** (ATTACHING PARTS) *****	83385	OBD
-67	386-1858-06			1		SUBPANEL,FRONT: ***** (ATTACHING PARTS) *****	80009	386-1858-06
-68	213-0192-00	B010100	B101354	4		SCR,TPG,THD FOR:6-32 X 0.50 INCH.PNH STL	87308	OBD
	213-0793-00	B101355		4		SCREW,TPG,TF:6-32 X 0.4375,TAPTITE,FIL	93907	OBD
-69	214-1876-00			4		PIN,GUIDE:PLUG-IN UNIT ***** (ATTACHING PARTS) *****	80009	214-1876-00

Fig & Index No.	Tektronix Part No.	Serial/Model No. Eff	Dscont	Qty	1 2 3 4 5	Name & Description	Mfr Code	Mfr Part Number
1-70	-----			1		CKT BOARD ASSY: VERT MODE SWITCH(SEE REPL) ***** (ATTACHING PARTS) *****		
-71	211-0116-00	B010100	B091289	2		SCR.ASSEM WSHR: 4-40 X 0.312 INCH.PNH BRS	83385	OBD
	211-0292-00	B091290		2		SCR.ASSEM WSHR: 4-40 X 0.29.BRS NI PL	78189	OBD
-72	210-0586-00			2		NUT.PL.ASSEM WA: 4-40 X 0.25.STL ***** (END ATTACHING PARTS) *****	83385	OBD
	-----			-		CKT BOARD ASSY INCLUDES:		
-73	131-0608-00			37		.TERMINAL.PIN: 0.365 L X 0.025 PH BRZ GOLD	22526	47357
-74	-----			1		.SWITCH.PUSH(SEE S300 THRU S308 REPL)		
-75	361-0384-00			5		.SPACER.PB SW: 0.133 INCH LONG	80009	361-0384-00
-76	366-1257-17			1		PUSH BUTTON: GRAY--CH1 DUAL	80009	366-1257-17
-77	366-1257-18			1		PUSH BUTTON: GRAY--TRACE CH 2	80009	366-1257-18
-78	366-1257-16			1		PUSH BUTTON: GRAY--ADD	80009	366-1257-16
-79	366-1402-69			1		PUSH BUTTON: GRAY--CH1 Y CH2 X	80009	366-1402-69
-80	366-1402-70			1		PUSH BUTTON: GRAY--LO NOISE	80009	366-1402-70
-81	407-1243-00			1		BRACKET.SWITCH: ALUMINUM ***** (ATTACHING PARTS) *****	80009	407-1243-00
-82	211-0541-00			2		SCREW.MACHINE: 6-32 X 0.25" 100 DEG.FLH STL ***** (END ATTACHING PARTS) *****	83385	OBD
-83	386-2463-00			1		PANEL.REAR: ***** (ATTACHING PARTS) *****	80009	386-2463-00
-84	213-0192-00	B010100	B101354	8		SCR.TPG.THD FOR: 6-32 X 0.50 INCH.PNH STL	87308	OBD
	213-0793-00	B101355		8		SCREW.TPG.TF: 6-32 X 0.4375.TAPTITE.FIL ***** (END ATTACHING PARTS) *****	93907	OBD
-85	351-0217-00			2		GUIDE.CKT CARD: PLASTIC ***** (ATTACHING PARTS) *****	80009	351-0217-00
-86	211-0507-00			8		SCREW.MACHINE: 6-32 X 0.312 INCH.PNH STL	83385	OBD
-87	220-0556-00			8		NUT.SLEEVE: 6-32 X 0.252 OD X 0.015" L B ***** (END ATTACHING PARTS) *****	80009	220-0556-00
-88	-----			1		CKT BOARD ASSY: HORIZ INTERFACE(SEE REPL)		
-89	131-0566-00			1		.BUS CONDUCTOR: DUMMY RES.2.375.22 AWG	57668	JWW-0200E0
-90	131-0608-00	B010100	B060493	26		.TERMINAL.PIN: 0.365 L X 0.025 PH BRZ GOLD	22526	47357
	131-0608-00	B060494		29		.TERMINAL.PIN: 0.365 L X 0.025 PH BRZ GOLD	22526	47357
	131-0707-00	B060494		6		.CONNECTOR.TERM: 22-26 AWG.BRS & CU BE GOLD	22526	47439
	352-0161-00	B060494		2		.HLDR.TERM CONN: 3 WIRE.BLACK	80009	352-0161-00
	175-0826-00	B060494		FT		.WIRE.ELECTRICAL: 3 WIRE RIBBON	80009	175-0826-00
-91	136-0252-07			43		.SOCKET.PIN CONN: W/O DIMPLE	22526	75060-012
-92	-----			1		CKT BOARD ASSY: VERT INTERFACE(SEE REPL)		
-93	131-0566-00			1		.BUS CONDUCTOR: DUMMY RES.2.375.22 AWG	57668	JWW-0200E0
-94	131-0608-00	B010100	B060493	32		.TERMINAL.PIN: 0.365 L X 0.025 PH BRZ GOLD	22526	47357
	131-0608-00	B060494		35		.TERMINAL.PIN: 0.365 L X 0.025 PH BRZ GOLD	22526	47357
-95	136-0252-07			49		.SOCKET.PIN CONN: W/O DIMPLE	22526	75060-012
-96	407-1242-00			2		BRACKET.ANGLE: ALUMINUM ***** (ATTACHING PARTS) *****	80009	407-1242-00
-97	211-0038-00			2		SCREW.MACHINE: 4-40 X 0.312.FLH.100 DEG	83385	OBD
-98	210-0586-00			2		NUT.PL.ASSEM WA: 4-40 X 0.25.STL ***** (END ATTACHING PARTS) *****	83385	OBD
-99	426-0505-17			1		FR SECT.PLUG-IN: TOP LEFT	80009	426-0505-17
-100	426-0505-16			1		FR SECT.PLUG-IN: TOP RIGHT	80009	426-0505-16
-101	426-0499-18			1		FR SECT.PLUG-IN: BOTTOM LEFT	80009	426-0499-18
-102	426-0499-17			1		FR SECT.PLUG-IN: BOTTOM RIGHT	80009	426-0499-17
-103	179-1903-00			1		WIRING HARNESS.: FRONT PANEL	80009	179-1903-00
-104	131-0707-00			25		.CONNECTOR.TERM: 22-26 AWG.BRS & CU BE GOLD	22526	47439
	131-0708-00			2		.CONTACT.ELEC: 0.48" L.28-32 AWG WIRE	22526	47437
-105	352-0161-00			4		.HLDR.TERM CONN: 3 WIRE.BLACK	80009	352-0161-00
-106	352-0163-00			1		.CONN BODY.PL.EL: 5 WIRE BLACK	80009	352-0163-00
-107	352-0164-00			1		.CONN BODY.PL.EL: 6 WIRE BLACK	80009	352-0164-00
-108	352-0165-00			1		.CONN BODY.PL.EL: 7 WIRE BLACK	80009	352-0165-00
-109	214-1061-00			1		SPRING.GROUND: FLAT	80009	214-1061-00
	198-2188-00			1		WIRE SET.ELEC:	80009	198-2188-00
-110	131-0707-00			94		.CONNECTOR.TERM: 22-26 AWG.BRS & CU BE GOLD	22526	47439
	131-0621-00			6		.CONNECTOR.TERM: 22-26 AWG.BRS & CU BE GOLD	22526	46231
-111	175-0825-00			FT		.WIRE.ELECTRICAL: 2 WIRE RIBBON	80009	175-0825-00

Replaceable Mechanical Parts—7S14

Fig. & Index No.	Tektronix Part No.	Serial Model No.		Qty	1	2	3	4	5	Name & Description	Mfr Code	Mfr Part Number
		Eff	Dscont									
1-112	175-0826-00			FT						.WIRE,ELECTRICAL:3 WIRE RIBBON	80009	175-0826-00
-113	175-0827-00			FT						.CABLE.SP.ELEC:4,26 AWG,STRD.PVC JKT,RBN	08261	SS04267(1061)0C
-114	175-0828-00			FT						.WIRE,ELECTRICAL:5 WIRE RIBBON	08261	SS-0526-710610C
-115	175-0829-00			FT						.WIRE,ELECTRICAL:6 WIRE RIBBON	08261	SS-0626-710610C
-116	175-0830-00			FT						.WIRE,ELECTRICAL:7 WIRE RIBBON	08261	SS-0726-710610C
-117	175-0831-00			FT						.WIRE,ELECTRICAL:8 WIRE RIBBON	08261	SS-0826-710610C
-118	352-0169-00			2						.HLDR,TERM CONN:2 WIRE BLACK	80009	352-0169-00
-119	352-0161-00			4						.HLDR,TERM CONN:3 WIRE,BLACK	80009	352-0161-00
-120	352-0162-00			4						.HLDR,TERM CONN:4 WIRE BLACK	80009	352-0162-00
-121	352-0163-00			4						.CONN BODY,PL,EL:5 WIRE BLACK	80009	352-0163-00
-122	352-0164-00			2						.CONN BODY,PL,EL:6 WIRE BLACK	80009	352-0164-00
-123	352-0165-00			2						.CONN BODY,PL,EL:7 WIRE BLACK	80009	352-0165-00
-124	352-0166-00			2						.CONN BODY,PL,EL:8 WIRE BLACK	80009	352-0166-00
-125	352-0199-00			2						.CONN BODY,PL,EL:3 WIRE BLACK	80009	352-0199-00
	198-2465-00			1						WIRE SET,ELEC.	80009	198-2465-00
	131-0707-00			14						.CONNECTOR,TERM:22-26 AWG,BRS & CU BE GOLD	22526	47439
	175-0826-00			FT						.WIRE,ELECTRICAL:3 WIRE RIBBON	80009	175-0826-00
	352-0161-00			2						.HLDR,TERM CONN:3 WIRE,BLACK	80009	352-0161-00
	352-0162-00			2						.HLDR,TERM CONN:4 WIRE BLACK	80009	352-0162-00

Fig. & Index No.	Tektronix Part No.	Serial/Model No. Eff	Dscont	Qty	1 2 3 4 5	Name & Description	Mfr Code	Mfr Part Number
2-1	-----			1		CKT BOARD ASSY:TRIGGER(SEE REPL)(ATTACHING PARTS).....		
-2	211-0116-00			1		SCR,ASSEM WSHR:4-40 X 0.312 INCH,PNH BRS(END ATTACHING PARTS).....	83385	OBD
-3	-----			-		CKT BOARD ASSY INCLUDES:		
	136-0252-04	B010100	B069999	63		.SOCKET,PIN TERM:U/W 0.016-0.018 DIA PINS	22526	75060-007
	136-0252-07	B070000		73		.SOCKET,PIN CONN:W/O DIMPLE	22526	75060-012
-4	136-0263-03	B010100	B060505	12		.SOCKET,PIN TERM:FOR 0.025 INCH SQUARE PIN	00779	85864-2
	136-0263-04	B060506		12		.SOCKET,PIN TERM:FOR 0.025 INCH SQUARE PIN	22526	75377-001
	131-0566-00	B050429		3		.BUS CONDUCTOR:DUMMY RES.2.375.22 AWG	57668	JWW-0200E0
-5	366-1402-67			1		PUSH BUTTON:GRAY--INT CH1	80009	366-1402-67
-6	366-1402-68			1		PUSH BUTTON:GRAY--HF SYNC	80009	366-1402-68
-7	366-1402-01			1		PUSH BUTTON:GRAY--START	80009	366-1319-00
-8	366-1489-02			1		PUSH BUTTON:GRAY--SWP	80009	366-1489-00
-9	366-1257-26			1		PUSH BUTTON:GRAY--AUTO TRIG	80009	366-1257-26
-10	366-1257-28			1		PUSH BUTTON:GRAY--+ SLOPE	80009	366-1257-28
-11	366-1402-66			1		PUSH BUTTON:GRAY--REP	80009	366-1402-66
-12	366-1489-32			1		PUSH BUTTON:GRAY--SINGLE SCAN	80009	366-1489-32
-13	366-1402-72			1		PUSH BUTTON:GRAY--MAN	80009	366-1402-72
-14	366-1257-24			1		PUSH BUTTON:GRAY--EXT	80009	366-1257-24
-15	384-1058-00			1		EXTENSION SHAFT:8.157 INCH LONG	80009	384-1058-00
-16	384-1099-00			2		EXTENSION SHAFT:PUSH BUTTON,1.54 INCH LONG	80009	384-1099-00
	334-3448-00	B080919		1		MARKER.IDENT:MARKED NOTICE	80009	334-3448-00
-17	-----			1		CKT BOARD ASSY:HORIZONTAL(SEE REPL)(ATTACHING PARTS).....		
-18	213-0146-00			4		SCR,TPG,THD FOR:6-20 X 0.313 INCH,PNH STL	83385	OBD
-19	210-1092-00			4		WASHER,FLAT:0.147 ID X 0.312" OD,BRS	12327	OBD
-20	342-0227-00			1		INSULATOR,SW:PUSH SWITCH(END ATTACHING PARTS).....	80009	342-0227-00
-21	-----			-		CKT BOARD ASSY INCLUDES:		
	131-0608-00			68		.TERMINAL,PIN:0.365 L X 0.025 PH BRZ GOLD	22526	47357
	131-0590-00			12		.CONTACT,ELEC:0.71 INCH LONG	22526	47351
-22	131-1003-00			4		.CONN,RCPT,ELEC:CKT BD MT,3 PRONG	80009	131-1003-00
-23	136-0252-07			224		.SOCKET,PIN CONN:W/O DIMPLE	22526	75060-012
-24	386-1557-00			1		.SPACER,CKT BD:0.29 H,ACETAL	80009	386-1557-00
-25	351-0213-00			1		.POST,CKT BD MTG:0.285 L X 0.219 OD,BRS	80009	351-0213-00
-26	-----			1		.SWITCH,PUSH:(SEE S210 REPL)		
-27	-----			1		.SWITCH,PUSH:(SEE S310,S312,S410,S412,S510 .S512 REPL)		
-28	361-0382-00			6		.SPACER,PB SW:BROWN,0.275 INCH LONG	80009	361-0382-00
-29	-----			1		.SWITCH,PUSH:(SEE S480 REPL)		
-30	-----			1		.SWITCH,PUSH:(SEE S320,S420 EPL)		
-31	361-0384-00			6		.SPACER,PB SW:0.133 INCH LONG	80009	361-0384-00
	198-2900-00			1		.WIRE SET,ELEC:	80009	198-2900-00
-32	352-0169-00			1		..HLDR,TERM CONN:2 WIRE BLACK	80009	352-0169-00
-33	352-0161-00			1		..HLDR,TERM CONN:3 WIRE,BLACK	80009	352-0161-00
-34	175-0825-00			FT		..WIRE,ELECTRICAL:2 WIRE RIBBON	80009	175-0825-00
-35	175-0826-00			FT		..WIRE,ELECTRICAL:3 WIRE RIBBON	80009	175-0826-00
-35.1	131-0707-00			5		..CONNECTOR,TERM:22-26 AWG,BRS & CU BE GOL	22526	47439
	-----			1		.SW CAM ACTR AS:(SEE S240,S260 REPL)(ATTACHING PARTS).....		
-36	211-0116-00			6		SCR,ASSEM WSHR:4-40 X 0.312 INCH,PNH BRS(END ATTACHING PARTS).....	83385	OBD
-37	-----			-		.ACTUATOR ASSEMBLY INCLUDES:		
	200-1489-00			1		..COVER,CAM SW:14 AND 20 ELEMENT(ATTACHING PARTS).....	80009	200-1489-00
-38	211-0022-00			3		..SCREW,MACHINE:2-56 X 0.188 INCH,PNH STL	83385	OBD
-39	210-0001-00			3		..WASHER,LOCK:INTL,0.092 ID X 0.18" OD,ST	78189	1202-00-00-0541C
-40	210-0405-00			3		..NUT,PLAIN,HEX.:2-56 X 0.188 INCH,BRS(END ATTACHING PARTS).....	73743	12157-50
-41	384-1189-00			1		..EXTENSION SHAFT:10.125 INCH LONG	80009	384-1189-00
-42	376-0039-00			1		..ADPT,SHAFT,CPLG:0.128 AND 0.082" DIA SHAF	80009	376-0039-00

Replaceable Mechanical Parts—7S14

Fig. & Index No.	Tektronix Part No.	Serial/Model No. Eff	Dscont	Qty	1 2 3 4 5	Name & Description	Mfr Code	Mfr Part Number
2-43	-----			1		..RESISTOR.VARIABLE:(SEE R178 REPL)(ATTACHING PARTS).....		
-44	213-0304-00			2		..SETSCREW:6-32 X 0.156 ".HEX.SOC.STL	00141	CS-3
-45	129-0424-00			1		..POST,ELEC-MECH:0.375-32 X 0.5 X 1.44" LON	80009	129-0424-00
-46	210-0012-00			1		..WASHER,LOCK:INTL.0.375 ID X 0.50" OD S(END ATTACHING PARTS).....	78189	1220-02-00-0541C
-47	354-0219-00			2		..RING.RETAINING:FOR 0.25 INCH SHAFT	79136	5103-25-MD-R
-48	214-1139-00			-		..SPRING,FLAT:0.885 X 0.156 CU BE GLD CLR ..(REPLACE ONLY WITH PART BEARING THE ..SAME COLOR CODE AS THE ORIGINAL PART ..IN YOUR INSTRUMENT)	80009	214-1139-00
	214-1139-02			-		..SPRING,FLAT:GREEN COLORED	80009	214-1139-02
	214-1139-03			-		..SPRING,FLAT:RED COLORED ..(REPLACE ONLY WITH PART BEARING THE SAM ..COLOR CODE AS THE ORIGINAL PART IN YOU ..INSTRUMENT)	80009	214-1139-03
-49	214-1127-00			2		..ROLLER,DETENT:0.125 DIA X 0.125,SST ..(REPLACE ONLY WITH PART BEARING THE SAM ..COLOR CODE AS THE ORIGINAL PART IN YOU ..INSTRUMENT)	80009	214-1127-00
-50	401-0057-00			1		..BEARING,CAM SW:FRONT	80009	401-0057-00
-51	401-0055-00			1		..BEARING,CAM SW:CENTER,0.83 DIA CAM	80009	401-0055-00
-52	401-0054-00			1		..BEARING,CAM SW:FRONT	80009	401-0054-00
-53	105-0427-00			1		..ACTUATOR,CAM SW:A TIME/CM	80009	105-0427-00
-54	105-0428-00			1		..ACTUATOR,CAM SW:B TIME/CM	80009	105-0428-00
-55	210-0406-00			6		..NUT,PLAIN,HEX.:4-40 X 0.188 INCH,BRS	73743	12161-50
-56	-----			1		CKT BOARD ASSY:SAMPLER COVER(SEE REPL)(ATTACHING PARTS).....		
-57	211-0180-00			11		SCR,ASSEM WSHR:2-56 X 0.25 INCH,PNH BRS(END ATTACHING PARTS).....	83385	OBD
	-----			-		CKT BOARD ASSY INCLUDES:		
-58	131-0787-00			16		..CONTACT,ELEC:0.64 INCH LONG	22526	47359
-59	136-0327-01			18		..SOCKET,PIN TERM:0.067 INCH DIA	00779	86281-2
-60	-----			2		CKT BOARD ASSY:SAMPLER(SEE REPL)(ATTACHING PARTS).....		
-61	211-0180-00			8		SCR,ASSEM WSHR:2-56 X 0.25 INCH,PNH BRS(END ATTACHING PARTS).....	83385	OBD
	-----			-		CKT BOARD ASSY INCLUDES:		
-62	342-0354-00	B080000		4		..INSULATOR,PLATE:TRANSISTOR,SILICON RUBBER	000BB	7403-10-52
-63	131-1003-00			2		..CONN,RCPT,ELEC:CKT BD MT.3 PRONG	80009	131-1003-00
-64	131-1321-00			2		..CONNECTOR,RCPT.:MINIATURE COAX	24931	33JR119-1
-65	136-0252-07			48		..SOCKET,PIN CONN:W/O DIMPLE	22526	75060-012
-66	136-0327-01	B010100	B060505	16		..SOCKET,PIN TERM:0.067 INCH DIA	00779	86281-2
	136-0263-04	B060506		16		..SOCKET,PIN TERM:FOR 0.025 INCH SQUARE PIN	22526	75377-001
-67	337-1884-00			2		..SHLD,ELECTRICAL:SAMPLER CIRCUIT CARD	80009	337-1884-00
-68	-----			1		CKT BOARD ASSY:SIGNAL BYPASS(SEE REPL)(ATTACHING PARTS).....		
-69	211-0116-00	B010100	B091289	4		SCR,ASSEM WSHR:4-40 X 0.312 INCH,PNH BRS	83385	OBD
	211-0292-00	B091290		4		SCR,ASSEM WSHR:4-40 X 0.29,BRS NI PL(END ATTACHING PARTS).....	78189	OBD
	-----			-		CKT BOARD ASSY INCLUDES:		
-70	131-0608-00			42		..TERMINAL,PIN:0.365 L X 0.025 PH BRZ GOLD	22526	47357
-71	131-0589-00			2		..TERMINAL,PIN:0.46 L X 0.025 SQ	22526	48283-029
-72	131-0594-00			6		..POST,BDG,ELEC:BLACK	22526	47356
-73	131-0787-00			12		..CONTACT,ELEC:0.64 INCH LONG	22526	47359
-74	136-0252-07			107		..SOCKET,PIN CONN:W/O DIMPLE	22526	75060-012
-75	214-0579-00			13		..TERM,TEST POINT:BRS CD PL	80009	214-0579-00
-76	337-1914-00			1		..SHLD,ELECTRICAL:TWO CAVITY HONEYCOMB	80009	337-1914-00
-77	200-1444-00			4		COVER,COMP BOX:(ATTACHING PARTS).....	80009	200-1444-00
-78	211-0022-00			16		SCREW,MACHINE:2-56 X 0.188 INCH,PNH STL(END ATTACHING PARTS).....	83385	OBD

Fig. & Index No.	Tektronix Part No.	Serial/Model No. Eff Dscont	Qty	1 2 3 4 5	Name & Description	Mfr Code	Mfr Part Number
2-79	-----		1		CKT BOARD ASSY:CH 1 COMPENSATION(SEE REPL) ***** (ATTACHING PARTS)*****		
-80	211-0008-00		4		SCREW,MACHINE:4-40 X 0.250.PNH.STL.CD PL ***** (END ATTACHING PARTS)*****	83385	OBD
	-----		-		CKT BOARD ASSY INCLUDES:		
-81	131-1003-00		1		.CONN.RCPT,ELEC:CKT BD MT.3 PRONG	80009	131-1003-00
-82	131-1408-00		2		.CONTACT,ELEC:OUTER SLEEVE	24931	OC114-3
-83	136-0252-07		1		.SOCKET,PIN CONN:W/O DIMPLE	22526	75060-012
-84	211-0007-00		4		.SCREW,MACHINE:4-40 X 0.188 INCH.PNH STL	83385	OBD
-85	103-0165-00		2		.ADAPTER,CA END:COMPENSATOR BOX	80009	103-0165-00
-86	-----		1		CKT BOARD ASSY:CH 2 COMPENSATION(SEE REPL) ***** (ATTACHING PARTS)*****		
-87	211-0008-00		4		SCREW,MACHINE:4-40 X 0.250.PNH.STL.CD PL ***** (END ATTACHING PARTS)*****	83385	OBD
	-----		-		CKT BOARD ASSY INCLUDES:		
-88	131-1408-00		2		.CONTACT,ELEC:OUTER SLEEVE	24931	OC114-3
-89	211-0007-00		4		.SCREW,MACHINE:4-40 X 0.188 INCH.PNH STL	83385	OBD
-90	103-0165-00		2		.ADAPTER,CA END:COMPENSATOR BOX	80009	103-0165-00
	-----		1		DELAY LINE,ELEC:(SEE DL1,DL2 REPL) ***** (ATTACHING PARTS)*****		
-91	211-0578-00		4		SCREW,MACHINE:6-32 X 0.438 1INCH.PNH STL	83385	OBD
-92	213-0146-00		4		SCR,TPG,THD FOR:6-20 X 0.313 INCH.PNH STL ***** (END ATTACHING PARTS)*****	83385	OBD
	-----		-		DELAY LINE ASSEMBLY INCLUDES:		
-93	407-1180-00		1		.BRACKET,CONN:ALUMINUM ***** (ATTACHING PARTS)*****	80009	407-1180-00
-94	211-0504-00		3		.SCREW,MACHINE:6-32 X 0.25 INCH.PNH STL ***** (END ATTACHING PARTS)*****	83385	OBD
-95	386-2395-00		1		.PLATE,DLY LINE:LEFT ***** (ATTACHING PARTS)*****	80009	386-2395-00
-96	211-0559-00		2		.SCREW,MACHINE:6-32 X 0.375 100 DEG.FLH ST ***** (END ATTACHING PARTS)*****	83385	OBD
-97	386-2393-00		1		.PLATE,DLY LINE:RIGHT ***** (ATTACHING PARTS)*****	80009	386-2393-00
-98	211-0559-00		2		.SCREW,MACHINE:6-32 X 0.375 100 DEG.FLH ST ***** (END ATTACHING PARTS)*****	83385	OBD
-99	129-0395-00		4		.POST,ELEC-MECH:6-32 X 0.60 OD X 0.89 LONG ***** (ATTACHING PARTS)*****	80009	129-0395-00
-100	213-0312-00		4		.SETSCREW:6-32 X 0.625 INCH,HEX SOC S ***** (END ATTACHING PARTS)*****	71159	OBD
-101	386-2394-00		1		.PLATE,DLY LINE:CENTER	80009	386-2394-00
-102	-----		1		CKT BOARD ASSY:READOUT(SEE REPL) ***** (ATTACHING PARTS)*****		
-103	211-0116-00		4		SCR,ASSEM WSHR:4-40 X 0.312 INCH.PNH BRS ***** (END ATTACHING PARTS)*****	83385	OBD
	-----		-		CKT BOARD ASSY INCLUDES:		
-104	131-0589-00		55		.TERMINAL,PIN:0.46 L X 0.025 SQ	22526	48283-029
-105	131-0608-00		3		.TERMINAL,PIN:0.365 L X 0.025 PH BRZ GOLD	22526	47357
-106	136-0252-04		18		.SOCKET,PIN TERM:U/W 0.016-0.018 DIA PINS	22526	75060-007
-107	407-1390-00		1		BRACKET,ANGLE:ALUMINUM ***** (ATTACHING PARTS)*****	80009	407-1390-00
-108	211-0008-00		1		SCREW,MACHINE:4-40 X 0.250.PNH,STL,CD PL	83385	OBD
-109	211-0038-00		2		SCREW,MACHINE:4-40 X 0.312,FLH,100 DEG ***** (END ATTACHING PARTS)*****	83385	OBD
	198-1661-00		1		WIRE SET,ELEC:	80009	198-1661-00
-110	131-0707-00		30		.CONNECTOR,TERM:22-26 AWG,BRS & CU BE GOLD	22526	47439
-111	131-0708-00		2		.CONTACT,ELEC:0.48 L,28-32 AWG WIRE	22526	47437
	131-2428-00		6		.CONN PLUG,ELEC:18-20 AWG,BRS & CU BE GOLD	22526	47441
	198-2915-00		1		WIRE SET,ELEC:	80009	198-2915-00
	131-0707-00		6		.CONNECTOR,TERM:22-26 AWG,BRS & CU BE GOLD	22526	47439
-112	175-0826-00		FT		.WIRE,ELECTRICAL:3 WIRE RIBBON	80009	175-0826-00
-113	352-0161-00		2		.HLDR,TERM CONN:3 WIRE,BLACK	80009	352-0161-00
	198-2417-00		1		WIRE SET,ELEC:	80009	198-2417-00

Replaceable Mechanical Parts—7S14

Fig. & Index No.	Tektronix Part No.	Serial/Model No.		Qty	1 2 3 4 5	Name & Description	Mfr Code	Mfr Part Number
		Eff	Dscont					
2-114	179-1905-00			1		WIRING HARNESS.:READOUT	80009	179-1905-00
-115	131-0707-00			73		.CONNECTOR,TERM:22-26 AWG,BRS & CU BE GOLD	22526	47439
-116	352-0169-00			4		.HLDR,TERM CONN:2 WIRE BLACK	80009	352-0169-00
-117	352-0161-00			1		.HLDR,TERM CONN:3 WIRE,BLACK	80009	352-0161-00
-118	352-0162-00			2		.HLDR,TERM CONN:4 WIRE BLACK	80009	352-0162-00
-119	352-0163-00			1		.CONN BODY,PL,EL:5 WIRE BLACK	80009	352-0163-00
-120	352-0164-00			1		.CONN BODY,PL,EL:6 WIRE BLACK	80009	352-0164-00
-121	352-0165-00			1		.CONN BODY,PL,EL:7 WIRE BLACK	80009	352-0165-00
-122	352-0166-00			2		.CONN BODY,PL,EL:8 WIRE BLACK	80009	352-0166-00
-123	352-0167-00			2		.HLDR,TERM CONN:9 WIRE BLACK	80009	352-0167-00
	179-1904-00			1		WIRING HARNESS.:VERTICAL	80009	179-1904-00
	131-0707-00			36		.CONNECTOR,TERM:22-26 AWG,BRS & CU BE GOLD	22526	47439
	131-0708-00			8		.CONTACT,ELEC:0.48"L,28-32 AWG WIRE	22526	47437
	352-0169-00			4		.HLDR,TERM CONN:2 WIRE BLACK	80009	352-0169-00
	352-0161-00			1		.HLDR,TERM CONN:3 WIRE,BLACK	80009	352-0161-00
	352-0162-00			2		.HLDR,TERM CONN:4 WIRE BLACK	80009	352-0162-00
	352-0164-00			1		.CONN BODY,PL,EL:6 WIRE BLACK	80009	352-0164-00
	352-0165-00			3		.CONN BODY,PL,EL:7 WIRE BLACK	80009	352-0165-00
	179-2032-00			1		WIRING HARNESS.:	80009	179-2032-00
	131-0707-00			8		.CONNECTOR,TERM:22-26 AWG,BRS & CU BE GOLD	22526	47439
	352-0166-00			1		.CONN BODY,PL,EL:8 WIRE BLACK	80009	352-0166-00

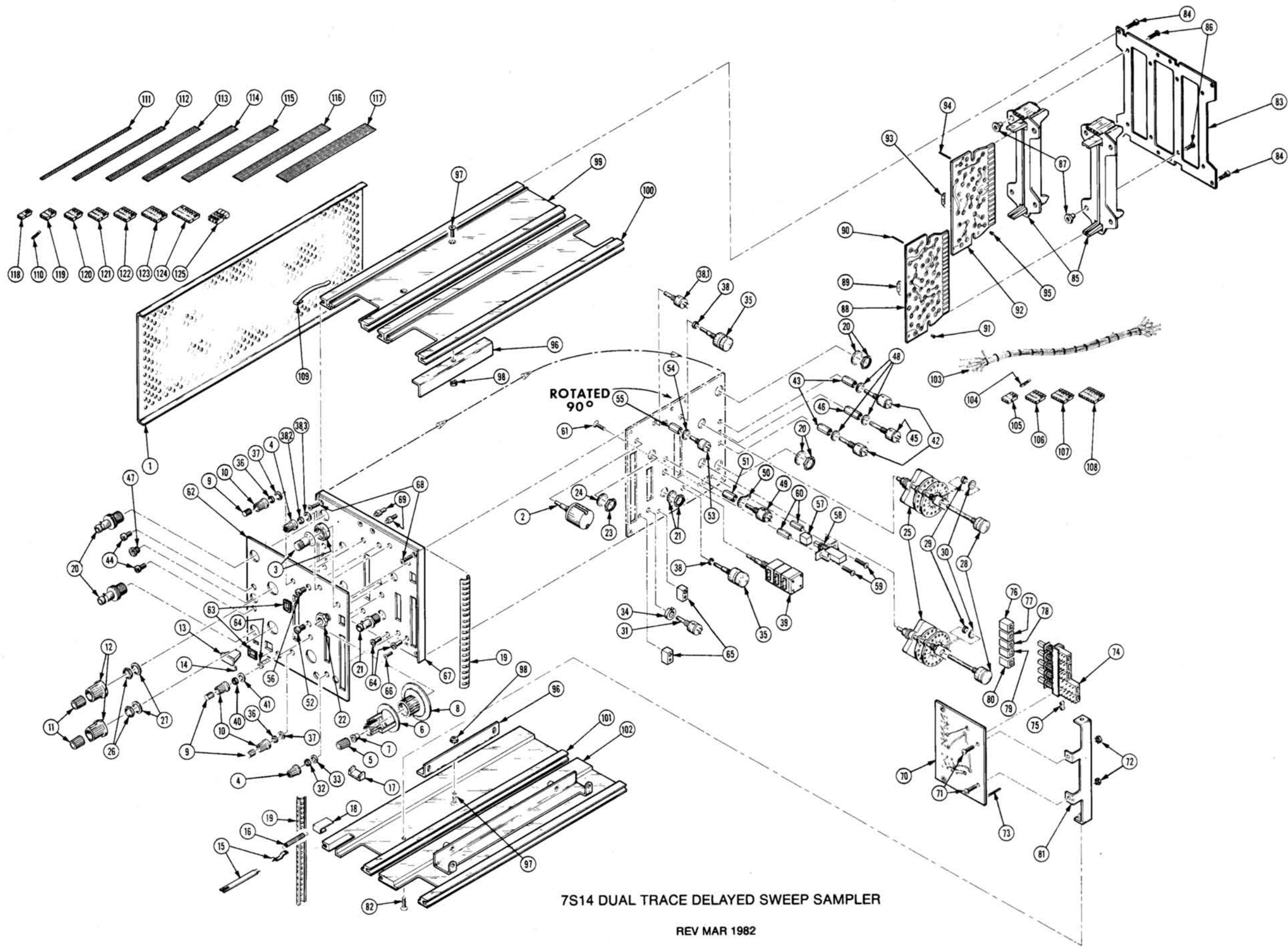

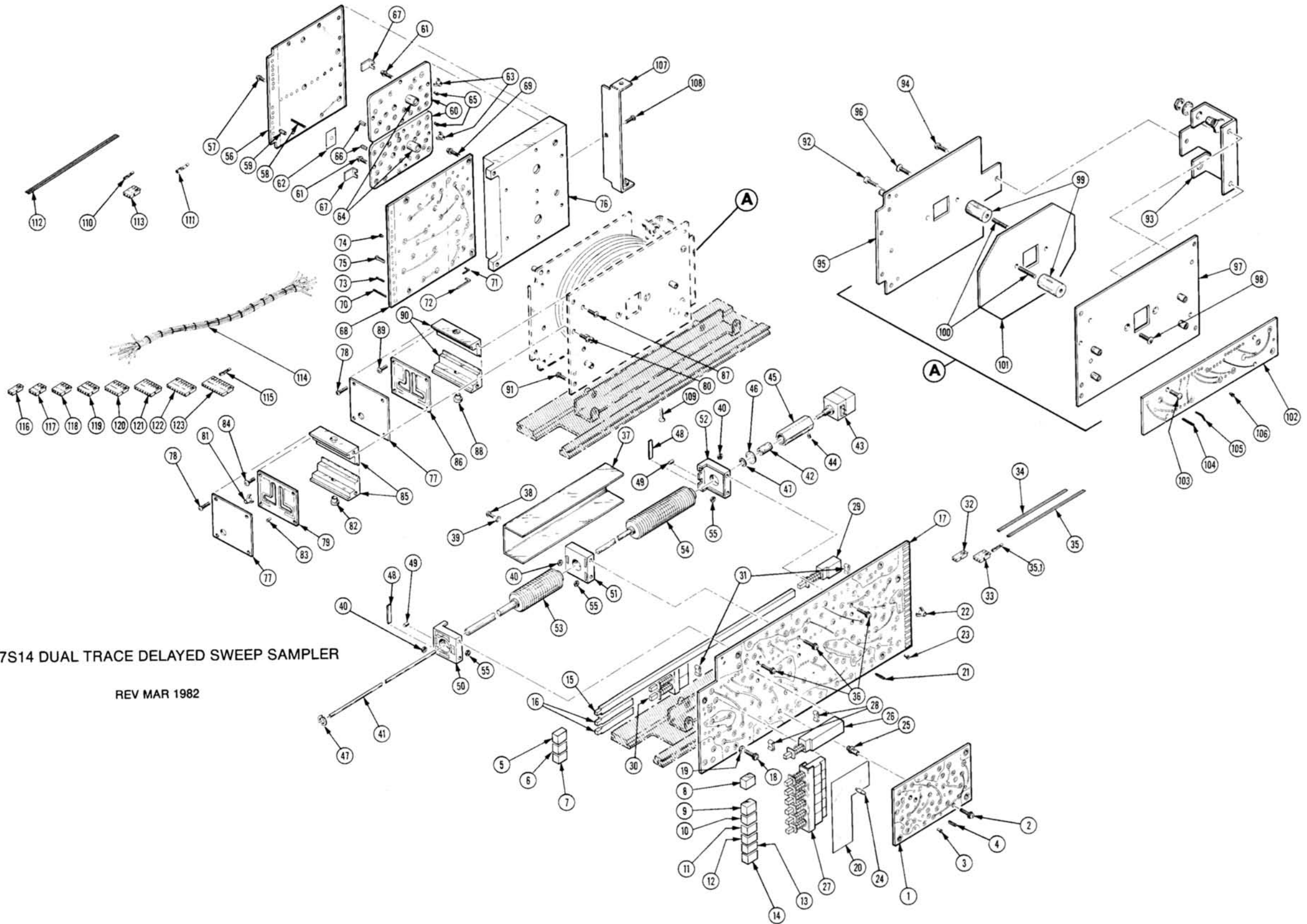

7S14 DUAL TRACE DELAYED SWEEP SAMPLER

REV MAR 1982

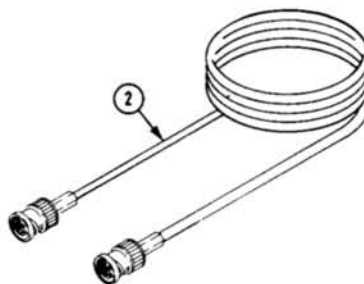

Fig. & Index No.	Tektronix Part No.	Serial/Model No.		Qty						Name & Description	Mfr Code	Mfr Part Number	
		Eff	Dscont		1	2	3	4	5				
-1	011-0059-02			2							ATTENUATOR,FXD:	80009	011-0059-02
-2	012-0057-01			2							CABLE ASSY,RF:COAXIAL,BNC	80009	012-0057-01
	070-1410-00			1							MANUAL,TECH:INSTRUCTION	80009	070-1410-00

MANUAL CHANGE INFORMATION

At Tektronix, we continually strive to keep up with latest electronic developments by adding circuit and component improvements to our instruments as soon as they are developed and tested.

Sometimes, due to printing and shipping requirements, we can't get these changes immediately into printed manuals. Hence, your manual may contain new change information on following pages.

A single change may affect several sections. Since the change information sheets are carried in the manual until all changes are permanently entered, some duplication may occur. If no such change pages appear following this page, your manual is correct as printed.

Date: 5-2-85 Change Reference: M55843

Product: 7S14 Manual Part No.: 070-1410-00

DESCRIPTION

Product Group 42

Effective at serial number B121810

REPLACEABLE ELECTRICAL PARTS LIST CHANGES

CHANGE TO:

CR420	152-0322-00	SEMICOND DEVICE:SILICON,15V,HOT CARRIER
CR421	152-0322-00	SEMICOND DEVICE:SILICON,15V,HOT CARRIER
CR440	152-0322-00	SEMICOND DEVICE:SILICON,15V,HOT CARRIER
CR450	152-0322-00	SEMICOND DEVICE:SILICON,15V,HOT CARRIER
CR462	152-0322-00	SEMICOND DEVICE:SILICON,15V,HOT CARRIER